



This is a digital copy of a book that was preserved for generations on library shelves before it was carefully scanned by Google as part of a project to make the world's books discoverable online.

It has survived long enough for the copyright to expire and the book to enter the public domain. A public domain book is one that was never subject to copyright or whose legal copyright term has expired. Whether a book is in the public domain may vary country to country. Public domain books are our gateways to the past, representing a wealth of history, culture and knowledge that's often difficult to discover.

Marks, notations and other marginalia present in the original volume will appear in this file - a reminder of this book's long journey from the publisher to a library and finally to you.

Usage guidelines

Google is proud to partner with libraries to digitize public domain materials and make them widely accessible. Public domain books belong to the public and we are merely their custodians. Nevertheless, this work is expensive, so in order to keep providing this resource, we have taken steps to prevent abuse by commercial parties, including placing technical restrictions on automated querying.

We also ask that you:

- + *Make non-commercial use of the files* We designed Google Book Search for use by individuals, and we request that you use these files for personal, non-commercial purposes.
- + *Refrain from automated querying* Do not send automated queries of any sort to Google's system: If you are conducting research on machine translation, optical character recognition or other areas where access to a large amount of text is helpful, please contact us. We encourage the use of public domain materials for these purposes and may be able to help.
- + *Maintain attribution* The Google "watermark" you see on each file is essential for informing people about this project and helping them find additional materials through Google Book Search. Please do not remove it.
- + *Keep it legal* Whatever your use, remember that you are responsible for ensuring that what you are doing is legal. Do not assume that just because we believe a book is in the public domain for users in the United States, that the work is also in the public domain for users in other countries. Whether a book is still in copyright varies from country to country, and we can't offer guidance on whether any specific use of any specific book is allowed. Please do not assume that a book's appearance in Google Book Search means it can be used in any manner anywhere in the world. Copyright infringement liability can be quite severe.

About Google Book Search

Google's mission is to organize the world's information and to make it universally accessible and useful. Google Book Search helps readers discover the world's books while helping authors and publishers reach new audiences. You can search through the full text of this book on the web at <http://books.google.com/>

THE
DEVELOPMENT

OF THE

LOCOMOTIVE

A POPULAR HISTORY

1803 - 1903



CLEMENT E. STRETTON

WEALE'S SCIENTIFIC & TECHNICAL SERIES.

CIVIL ENGINEERING & SURVEYING.

Civil Engineering. H. LAW & D. K. CLARK	6/6
Pioneer Engineering. E. DOBSON	4/6
Iron Bridges of Moderate Span. H. W. PENDRED.	2/-
Iron and Steel Bridges & Viaducts. F. CAMPIN	3/6
Constructional Steel & Ironwork. F. CAMPIN	3/6
Tubular & Girder Bridges. G. D. DEMPSEY	2/-
Materials and Construction. F. CAMPIN	3/-
Sanitary Work. C. SLAGG	3/-
Roads & Streets. LAW, CLARK, & WALLIS-TAYLER	6/-
Construction of Gasworks. S. HUGHES & W. RICHARDS	5/6
Water Works. S. HUGHES	4/-
Well-Sinking. J. G. SWINDELL & G. R. BURNELL	2/-

Library

of the

University of Wisconsin

Boilermaker's Ready Reckoner and Assistant	7/-
Steam Boilers. R. ARMSTRONG	1/6
Steam and Machinery Management. M. P. BALE.	2/6
Steam and the Steam Engine. D. K. CLARK	3/6
Steam Engine, Theory of. T. BAKER	1/6
Steam Engine. Dr. LARDNER	1/6
Locomotive Engines. G. D. DEMPSEY & D. K. CLARK	3/6
Locomotive Engine Driving. M. REYNOLDS	3/-
Stationary Engine Driving. M. REYNOLDS	3/6
Model Locomotive Engineer. M. REYNOLDS	3/6
Modern Workshop Practice. J. G. WINTON	3/6
Mechanical Engineering. F. CAMPIN	2/6
Details of Machinery. F. CAMPIN	3/-
Elementary Marine Engineering. J. S. BREWER	1/6

CROSBY LOCKWOOD & SON, 7, Stationers' Hall Court, E.C.

WEALE'S SCIENTIFIC & TECHNICAL SERIES.

MECHANICAL ENGINEERING, &c.—*contd.*

Sewing Machinery. J. W. URQUHART	2/-
Power of Water. J. GLYNN	2/-
Power in Motion. J. ARMOUR	2/-
Iron and Heat. J. ARMOUR	2/6
Mechanism and Machines. T. BAKER & J. NASMYTH	2/6
Mechanics. C. TOMLINSON	1/6
Cranes and Machinery. J. GLYNN	1/6
Smithy and Forge. W. J. E. CRANE	2/6
Sheet-Metal Worker's Guide. W. J. E. CRANE . . .	1/6
Elementary Electric Lighting. A. A. C. SWINTON .	1/6

MINING & METALLURGY.

Mining Calculations. T. A. O'DONAHUE	3/6
Mineralogy. A. RAMSAY	3/6
Coal Mining. Sir W. W. SMYTH & T. F. BROWN . .	3/6
Metallurgy of Iron. H. BAUERMAN	5/-
Mineral Surveyor's Guide. W. LINTERN	3/6
Slate and Slate Quarrying. D. C. DAVIES	3/-
Mining and Quarrying. J. H. COLLINS	1/6
Subterraneous Surveying. T. FENWICK & T. BAKER	2/6
Mining Tools. W. MORGANS	2/6
Plates to ditto. 4to.	4/6
Physical Geology. PORTLOCK & TATE	2/-
Historical Geology. R. TATE	2/6
The above 2 vols., bound together	4/6
Electro-Metallurgy. A. WATT	3/6

NAVIGATION, SHIPBUILDING, &c.

Navigation. J. GREENWOOD & W. H. ROSSER	2/6
Practical Navigation. GREENWOOD, ROSSER & LAW .	7/-
Navigation and Nautical Astronomy. J. R. YOUNG	2/6
Mathematical & Nautical Tables. LAW & YOUNG .	4/-
Masting and Rigging. R. KIPPING	2/-
Sails and Sailmaking. R. KIPPING	2/6
Marine Engines. R. MURRAY & G. CARLISLE . . .	4/6
Naval Architecture. J. PEAKE	3/6
Ships, Construction of. H. A. SOMMERFELDT . . .	1/6
Plates to ditto, 4to	7/6
Ships and Boats. W. BLAND	1/6

CROSBY LOCKWOOD & SON, 7, Stationers' Hall Court, E.C.

WEALE'S SCIENTIFIC & TECHNICAL SERIES.

AGRICULTURE & GARDENING.

Fertilisers & Feeding Stuffs.	DR. B. DYER . . .	1/-
Draining and Embanking.	PROF. J. SCOTT . . .	1/6
Irrigation and Water Supply.	PROF. J. SCOTT . . .	1/6
Farm Roads, Fences, and Gates.	PROF. J. SCOTT . . .	1/6
Farm Buildings.	PROF. J. SCOTT . . .	2/-
Barn Implements and Machines.	PROF. J. SCOTT . . .	2/-
Field Implements and Machines.	PROF. J. SCOTT . . .	2/-
Agricultural Surveying.	PROF. J. SCOTT . . .	1/6
The above 7 vols., bound together . . .		12/-
Farm Management.	R. S. BURN . . .	2/6
Landed Estates Management.	R. S. BURN . . .	2/6
Farming—Soils, Manures, and Crops.	R. S. BURN . . .	2/-
Farming—Outlines—Farming Economy.	R. S. BURN . . .	3/-
Farming—Cattle, Sheep, and Horses.	R. S. BURN . . .	2/6
Farming—Dairy, Pigs, and Poultry.	R. S. BURN . . .	2/-
Farming—Sewage & Irrigation.	R. S. BURN . . .	2/6
The above 5 vols., bound together . . .		12/-
Book-keeping for Farmers.	J. M. WOODMAN . . .	2/6
Ready Reckoner for Land.	A. ARMAN . . .	2/-
Miller's & Farmer's Ready Reckoner . . .		2/-
Hay and Straw Measurer.	J. STEELE . . .	2/-
Meat Production.	J. EWART . . .	2/6
The Sheep.	W. C. SPOONER . . .	3/6
Multum-in-Parvo Gardening.	S. WOOD . . .	1/-
Forcing Garden.	S. WOOD . . .	3/6
Market and Kitchen Gardening.	C. W. SHAW . . .	3/-
Kitchen Gardening.	G. M. F. GLENNY . . .	1/6
Cottage Gardening.	E. HOBDAY . . .	1/6
Garden Receipts.	C. W. QUIN . . .	1/6
Potatoes: How to Grow.	J. PINK . . .	2/-
Culture of Fruit Trees.	M. DU BREUIL . . .	3/6
Tree Planter & Plant Propagator.	S. WOOD . . .	2/-
Tree Pruner.	S. WOOD . . .	1/6
Tree Planter, Propagator, & Pruner.	S. WOOD . . .	3/6
Grafting and Budding.	C. BALTET . . .	2/6
Bees for Pleasure & Profit.	G. G. SAMSON . . .	1/-

CROSBY LOCKWOOD & SON, 7, Stationers' Hall Court, E.C.





MII

Frontispiece.





Clement H. Stetson.

THE
LOCOMOTIVE ENGINE
AND ITS DEVELOPMENT

*A POPULAR TREATISE ON
THE GRADUAL IMPROVEMENTS MADE IN
RAILWAY ENGINES BETWEEN
1803 AND 1903*

BY
CLEMENT E. STRETTON

MEMBER OF THE SOCIETY OF ENGINEERS, MEMBER OF THE RAILWAY CLUB
HON. MEMBER OF THE AMERICAN ENGINEERS' ASSOCIATION
SPECIAL REPRESENTATIVE IN ENGLAND OF THE TRANSPORTATION DEPARTMENT OF THE
CHICAGO EXHIBITION OF 1893
AUTHOR OF "SAFE RAILWAY WORKING," "THE HISTORY OF THE MIDLAND RAILWAY"
"THE HISTORY OF THE LONDON AND NORTH-WESTERN RAILWAY," AND
125 BOOKS AND PAMPHLETS ON RAILWAY SUBJECTS

WITH NUMEROUS ILLUSTRATIONS

Sixth Edition, Revised and Enlarged



LONDON
CROSBY LOCKWOOD AND SON
7, STATIONERS' HALL COURT, LUDGATE HILL
1903

76990

MAR 9 1904

TJD

ST8

AXD 3057

PREFACE

TO THE SIXTH EDITION.

THE approaching centenary of the railway locomotive, together with the consideration of the rapid developments which have taken place since this work was last issued, renders it very desirable that a new and sixth edition shall now be published, in order to bring the links in the chain of information up to the present day.

It is a remarkable fact that, although the steam engine has not yet been in use upon railways for a period of a hundred years, it has developed to the utmost of its powers upon railways as now constructed.

The modern locomotive, as illustrations and details given in this volume will show, has already been made of maximum dimensions; and in view of the loading gauge, the height of bridges, and the width between the various pairs of rails, it is difficult to see how better results can be obtained than those already given by the most modern engines.

When the first edition of this book was published,

the steam locomotive was practically the only means of propulsion for heavy weights and over long distances, and so long as the steam engine itself, with its tender, weighed only about 55 to 60 tons, and the average speed of trains did not exceed fifty miles an hour, nothing could be better than the steam locomotive; but now that loads have been vastly augmented and speeds increased, the size of the engine and tender has of necessity been enormously enlarged also, in many cases to 100, and even 110 tons, with the result that the railway locomotive has become an expensive and extravagant appliance.

This very great change in circumstances requires some further examination and consideration. Taking a case for comparison, attention should in the first place be directed to the year of the great "continuous brake trials," when various trains of the most up-to-date description were tried at Newark in 1875.

The average weight of the engines and tenders was then about 55 tons, and of the fifteen carriages about 150 tons. The express train of that period, therefore, weighed about 210 tons complete. The average speed on various lines would be from 43 to 46 miles an hour, and the coal consumption about 18 to 22 lbs. per mile.

Now let the details of a modern train be compared. The result will show that the engine and tender have doubled in weight. The train being increased to a load calculated as equal to twenty coaches, and composed of heavy carriages, such as dining carriages and corridor stock, will weigh fully 320 tons, or, with the engine and tender, about 420 tons. The average speed has increased to from 53 to 60 miles an hour, with the

result that the coal consumption has risen to 40, 50, and even 56 lbs. per mile, and often a second engine has to be taken. An enormous increase in working expenses is thus apparent, but this would be of no consequence if the paying load were proportionately increased.

This, unfortunately, it appears, is not the case, for the official returns show that the 210-ton express of 1875 carried more passengers, and brought in more receipts per mile, than the 420-ton express at the present day. In other words, it takes more steam, coal, and water now to convey an engine and tender alone than it did in 1875 to take the whole train and engine complete. The result is that expenses increase and shareholders' dividends fall.

For many years it was found that out of every pound sterling taken in receipts, 8s. was required for working expenses, and 12s. was available for appropriation as dividend or otherwise. Now the position is reversed, and the working expenses take about 12s. 3d., leaving a margin of only 7s. 9d.

Railway directors and engineers, seeing that no further economy can be obtained with use of the steam locomotive, have naturally turned their attention to "electric traction," and the question is being asked, "Why haul about at the head of each train a 100-ton engine when, by means of two electric wires or conductors, power to work the train can be generated by stationary engines placed every few miles along a railway, and the traction be effected far better and more cheaply by electricity than by the modern heavy steam locomotive?" And as this volume is passing through the press, reports come to hand of projected

“petrol-engine automobile” trains, said to be in construction in France and in England (see *post*, pp. 242-246).

In previous editions reference has been made to the “Stretton Railway Collection” which was prepared by the Author for the railway section of the Chicago Exhibition of 1893, and which, when placed in position, was found to consist of 1,500 photographs, books, drawings, papers, etc., and 10 tons weight of early railway rails. It should here be added that, since this collection was returned to England, the whole of it has been presented to the nation by the Author and his son, and as no building was available in which to place the complete collection, it has been distributed amongst various museums and free libraries at South Kensington, Liverpool, Leicester, Oxford, Crewe, Holyhead, and elsewhere. In a short time, no doubt, the various authorities will have completed the placing of the various exhibits in position for public inspection and use.

C. E. S.

SAXE COBURG HOUSE,
LEICESTER,
December, 1902.

CONTENTS.

	PAGE
INTRODUCTION:— Increase of Speed—Bogies—High Steam-Pressure—Long Runs—The Early Use of Steam—Steam Carriages intended to run upon Ordinary Roads	1
CHAPTER I.—EARLY LOCOMOTIVES USED UPON PRIVATE LINES FOR THE CONVEYANCE OF GOODS AND MINERALS:— Trevithick, the Father of the Locomotive—Rack-rails and Cog-wheels—George Stephenson's first Engine—Steam Springs—The Duke of Portland's Tram-road—Engines for the Hetton Colliery	5
CHAPTER II.—ENGINES EMPLOYED UPON PUBLIC RAILWAYS FOR THE CONVEYANCE OF PASSENGERS, GOODS, AND MINERALS:— The Stockton and Darlington the first Public Railway. Its Locomotive List—Wilson's Four-cylinder Engine—Hickworth's "Royal George"—The first Locomotive for America—Rainhill Trials—The Liverpool and Manchester Locomotive List—The Leicester and Swannington Locomotive List (<i>facing</i> p. 45)—Ancient Valve-gear—Grasshopper Springs—The first Steam Railway Whistle—A Bogie Engine—The first Six-coupled Goods Engine with inside Cylinders—Mr. Bury's Engines—Four Wheels <i>versus</i> Six—Forrester's Outside Cylinder Engines—Four Eccentrics introduced—Stephenson's "Standard" Passenger Engine—High Foundry Valve-gear	19
CHAPTER III.—THE COMMENCEMENT OF THE BATTLE OF THE GAUGES:— The "North Star"—List of Great Western Engines—The "Hurricane," the "Thunderer"—Ten-foot Driving-wheels a Failure—American Engines in England—McConnell's Tank Engine—Howe's Link Motion—The Long Boiler—Mr. Alexander Allan's Crewe Pattern—Crampton's Patent—A Three-Cylinder Engine—The Battle of the Gauges at its height—Eighty-one Miles an Hour—Trevithick's "Cornwall"—Mr. Ramsbottom's Engines—The Narrow Gauge Engines as fast as the Broad—Kirtley's Designs for Midland Railway Engines	72
CHAPTER IV.—MODERN LOCOMOTIVES FOR MAIN LINE TRAINS:— Steam-reversing Gear—Mineral Engines—Various Opinions	

	PAGE
on Compound Express Engines—Three Cylinders <i>versus</i> Two—Express Engines coupled in front—The Great Western Engines designed in 1891	122
CHAPTER V.—IMPORTANT DEVELOPMENTS:—Great Western Engines, single and coupled—North-Eastern, No. 1621 Class—Bogie Engines about to be used on the London and North-Western—The Winby Engine a Failure—The latest Brighton Engines—The latest Midland—Manchester, Sheffield, and Lincolnshire Engines	177
CHAPTER VI.—EIGHT-WHEELED COUPLED GOODS ENGINES	184
CHAPTER VII.—NOTES ON AMERICAN ENGINES:—Chicago Exhibition, 1893—No. 999—Running of an American Special Express—Pennsylvania Company's Engines—The latest American "Single," No. 385—The American Engines, why so successful	188
CHAPTER VIII.—IMPORTANT LINKS IN LOCOMOTIVE HISTORY:—Invention of the Bogie—Bar-framing Engines by Mr. Edward Bury—Early Engines on the Great Western Railway: "Vulcan," "Premier," "Lion," "Snake," "Ajax"—Great Western Company's "Leopard" (exploded 1857)—Great Western Company's Engines, 1847-1855—Old Broad Gauge Engines—"Jenny Lind," 1847—Midland Engine No. 60, Crampton's designs, McConnell's Nos. 300 and 373—Bristol and Exeter—Great Northern 215—Steam Tenders	198
CHAPTER IX.—RECENT LOCOMOTIVE PRACTICE.—The latest Manchester, Sheffield, and Lincolnshire Engines—Great Western—The Duke of Sutherland's Engine—North British—Caledonian No. 721—The latest North-Eastern	222
CHAPTER X.—MODERN DEVELOPMENTS—AUTOMOBILISM:—Third-class Dining Cars—Corridor Rolling-Stock—Four-cylinder Express Engines—Ten-wheel Express Engines—Belpaire Fire-box—Heating of Trains from the Locomotive—London and North-Western Railway's "King Edward VII." Four-cylinder Engine—Great Northern Railway's Four-cylinder, No. 271—Eight-wheel Coupled Goods Engine—Automobilism in France and on the North-Eastern Railway	232
CHAPTER XI.—MAIN QUESTIONS OF DESIGN—THEORY OF LOCOMOTIVE MOTION—RULES AS TO GRADIENTS—CENTRE OF GRAVITY OF LOCOMOTIVE—SUNDRY APPLIANCES	247
APPENDIX.—RAILWAY SPEED TABLE	265
INDEX	267

LIST OF ILLUSTRATIONS.

	PAGE		PAGE
The First Locomotive, 1803	5	Steam Trumpet, 1833	52
— "Blenkinsop," 1812	7	The "Experiment," L. & M. Ry., 1833	54
— "Puffing Billy," 1813	10	— "Earl of Airlie," 1833	55
Brunton's Engine, 1813	11	— "Hercules," 1833	56
Stephenson's First, 1814	12	— "Patentee," 1834	57
Do. Third, 1816	14	— "Atlas," L. & S. Ry., 1834	59
Do. end view	15	— "Liverpool," L. & S. Ry., 1834	61
Do. "Puffing Billy," as in 1815	17	— "Swiftsure" 1834	63
The "Locomotion," 1825	20	— "Comet," N. & C. Ry., 1835	64
— "Experiment," 1826	23	— "Vulcan," L. & S. Ry., 1835	66
— "Twin Sisters," 1827	24	Stephenson's Standard En- gine, 1836	67
— "Royal George," 1827	24	The "Atlas," N. & C. Ry., 1836	68
— "Lancashire Witch," 1828	25	— "Ajax," L. & S. Ry., 1837	69
— "America," 1828	26	Sharp's Engine, 1837	70
— "Agenoria," 1829	29	The "North Star," 1837	72
— "Rocket," 1829	31	— "Vulcan," G. W. R., 1837	201
— "Novelty," 1829	33	— "Premier," Do., 1838	202
— "Invicta," 1830	35	— "Lion," Do., 1838	203
— "Northumbrian," 1830	36	— "Snake," Do., 1838	203
— "Planet," 1830	38	— "Ajax," Do., 1838	204
— "Mercury," 1830	40	— "Ajax" Wheel, 1838	205
— "Samson," L. & M. Ry., 1831	41	Grand Junction Railway Engine, 1838	75
— "George Stephenson," 1831	42	The "Thunderer," 1838	<i>facing</i> 206
— "Stevens," 1831	189	— "Hurricane," 1838	76
— "Liverpool," Bury's, 1831	200	— "Victoria," 1838	78
— "Liver," Bury's, 1832	200	— "Hector," 1839	79
— "Comet," L. & S. Ry., 1832	44	Gooch's design, 1840	207
— "Phoenix," L. & S. Ry., 1832	46	The "Philadelphia," 1840	81
— "Wilberforce" 1832, <i>facing</i>	47	— "Long Boiler," 1842	84
— "Caledonian," 1832	49	Stephenson's Fork Motion	86
— "Ironsides," 1832	49		
— "Samson," L. & S. Ry., 1833	50		

	PAGE		PAGE
Howe's Link Motion, 1842	87	Metropolitan District En-	
Mr. Allan's Goods, 1843	91	gine	157
The "Great Western," 1846	95	Midland Express	161
Gray's design, 1846	97	Gradients of Midland Ry.	163
— "Iron Duke," 1847	209	Mr. Webb's Latest Com-	
— "Jenny Lind," 1847	212	pound	165
— "Velocipede," 1847	100	Mr. Dean's Design, 1891.	167
— "Cornwall," 1847 <i>facings</i>	102	Small Shunting Engine	175
— Do. 1868	101	Large Shunting Engine	176
N. E. No. 273, 1847	212	Great Western "Single"	179
The "Liverpool" (Cramp-		Great Western Coupled En-	
ton's), 1848	102	gine <i>facings</i>	180
Midland Railway "60,"		London and Brighton Bogie	
1848	213	Express <i>facings</i>	183
Crampton's designs	214, 215	American 999, 1893	191
The "Bloemer," 1850	105	"Dunrobin," 1895 <i>facings</i>	222
L. & N. W., 300, 1852		M. S. & L., No. 696, 1895	
<i>facings</i>	216	<i>facings</i>	224
B. & E. Ry., 1853	217	American Single Engine,	
G. N. Ry., 215, 1853	218	1895	196
The "Leopard," as in 1857.	208	"Dunalastair," 1896 <i>facings</i>	227
— "Problem," 1859	110	Midland Railway Three-	
L. & N. W., 373, 1861	219	Cylinder Compound	
The "Pacha," 1862	113	Express Engine, No.	
G. N. R. Steam Tenders,		2632 <i>Frontispiece</i>	
1863	221	London and North-Western	
No. 30 class (Midland), 1864	115	Four-Cylinder (1901)	
— 712 " " " " 1869	116	Compound Express,	
— 780 " " " " 1870	117	"King Edward VII."	235
— 800 " " " " 1870	119	Mr. Drummond's Four-Cy-	
— 800 tender " " 1870	120	linder (1901) Engine	
— 890 class " " 1871	121	<i>facings</i>	236
Glasgow & South-Western		Mr. Ivatt's Four-Cylinder	
Express, 1873	122	Express, No. 271 (1902)	237
The "Grosvenor," 1874	124	Lancashire and Yorkshire	
Midland Mineral, 1875	126	Railway's Ten-Wheeled	
Brighton Express, 1882	130	Express, No. 1400 (1899)	
Midland Goods	131	<i>facings</i>	238
Do. Tender	132	Mr. Worsdell's Six-Coupled	
Midland Express, 1885	134	Bogie Express, North-	
Caledonian Express, 1886	136	Eastern Railway (1900)	
Do. Tender	137	<i>facings</i>	238
Great Northern Express,		Mr. McIntosh's Eight-	
1870-1895	138	Coupled Mineral Eng-	
Great Eastern Express	141	gine, "600 class,"	
Manchester, Sheffield, and		Caledonian Railway	
Lincolnshire Express	145	(1901) <i>facings</i>	242
North-Eastern Express	148	Arrangement of Sand-Blast	256
London and South-Western		Details of Sand-Blast	257
Express	150	Details of Injector	260

INTRODUCTION.

THE great increase of power and speed mentioned in the preface will at once suggest the questions, How has it been attained? and, What are the particular improvements which have rendered it possible?

The improvement is due to three reasons. In the first place, all the main lines of the principal companies are laid with steel rails, and are in a state of most perfect efficiency, which has reduced the resistance considerably. Secondly, the introduction of "bogie" express engines has now become almost general, indeed hardly any passenger engines have been built without "bogies" during the past two years; and the large introduction of "bogie" carriages has also been a most important improvement. Thus it will be seen that the resistance to be overcome by the locomotive is considerably reduced. Thirdly, on the other hand, the power of the engines has been greatly increased by the use of higher steam pressure. Years ago 120 and 140 lbs. per square inch were the usual pressures; now 160, 175, and 180 are used, and 200 has been tried. The Author, however, is not in favour of less than 160, or more than 180. The extra pressure of from 20 to 40 lbs. per square inch may naturally be expected to add greatly to the work done by locomotives, and the fact that at least five miles an hour has been added to the maximum speed, together with the conveyance of heavier trains, is the practical result. The efficiency of design and

construction also enables "long runs" to be now made, which could not have been attempted some years ago.

As mentioned in previous editions, the amount of early locomotive history available is enormous, and discoveries of drawings, books, and miscellaneous information are frequently being made, including official details of engines and carriages which for years past have been unknown and forgotten. Quite recently some large rolls of old documents have been sent to the Author for examination, and have been found to contain drawings and full particulars of engines which were employed considerably more than half a century ago.

Attention should be directed to the fact, that in the early days of railways a very similar set of names was adopted by different lines for their locomotives. For instance, a "Comet," a "Phoenix," a "Samson," a "Goliath," a "Vulcan," an "Atlas," a "Liverpool," were to be found on nearly all lines, and the official lists prove that in 1840 no less than *ten* engines were running in this country named "Liver" and "Liverpool." This shows that those who desire to investigate the history of certain engines must be extremely careful not to be confused by the similarity of names.

Another difficulty is that several locomotive makers each built "trial engines" upon their own system or patent, and obtained the permission of certain companies to try them on their lines; in some cases the railway companies afterwards purchased the engines, in others they did not. As an instance, Mr. Bury, in 1830, built an engine named "Dreadnought;" it was, by permission, tried on no less than five lines, and then taken back to the works and broken up, but in 1831 most of the parts were used in a new engine named

“Liverpool,” which by permission of the Liverpool and Manchester Railway Company ran a trip on that line, and was at once purchased for the Petersburg Railroad of America, where soon after its arrival in May, 1831, it became known as the “Spitfire.” The Author happens to have the maker’s private number, marked upon the drawings, corresponding with that stamped upon parts of the engine itself, or it would have been impossible to trace its history.

In a similar way an engine named “John Bull” was sent from Newcastle to the Mohawk and Hudson Railroad in 1831, and immediately afterwards another engine named “Stevens” was sent from Newcastle to the Camden and Amboy Railroad, but upon its arrival in America the name was changed to “John Bull.” Some doubt was at one time expressed as to which “John Bull” was actually the one at the Chicago Exhibition; but by means of the old drawings, and an examination of the parts stamped with the maker’s number, the Author had no difficulty in deciding that the engine at Chicago was without doubt the one which had been first named “Stevens,” and the one with the round fire-box recorded by Wood in his book of 1838.

Locomotive historians, and others who are interested in the subject, would do well to always record the makers’ numbers of locomotives, as a comparison with the makers’ books and drawings will at any time prove the actual date when made and other details. An instance of this is seen with reference to the “North Star,” page 72. The engine was originally built for an American railway, and was actually sent on board ship to New York and back, before being altered for the Great Western Railway: by means of the maker’s

number—150—still upon the engine preserved at Swindon, all doubt as to its history is removed, and the fact that another engine was built for Russia, and numbered 163, proves that the two engines were not one and the same, as some persons have believed in consequence of their bearing the same name.

As some newspapers often profess to record very extraordinary rates of speed, it may be advisable to point out one possible cause of error. We should beware of "speed indicators" which take their motion from the driving wheels of engines, as the Author, when the train was running no more than 55 miles an hour, has seen an indicator go up to 90 miles an hour, the increase being simply due to the "slipping" of the driving wheels.

The power of steam was known to Hero of Alexandria about 200 B.C., or fully two thousand years ago, and a book he then wrote treated of the expansive force of steam, and described the cylinder, piston, slide-valve, and common clack-valve. But although the power of steam was *known*, no attempts appear to have been made to turn it to useful and practical effect, even in stationary engines, until 250 years ago.

In the year 1759, Dr. Robinson suggested to James Watt the idea of steam carriages for running upon common roads, and models were made. Cugnot, in 1769 and 1771, constructed steam carriages. Murdoch, in 1784, followed by many others, also made "models" and "suggestions" for working carriages by steam on ordinary roads; but it was not until the year 1803 that the first tram-road or railway locomotive was constructed

CHAPTER I.

EARLY LOCOMOTIVES USED UPON PRIVATE LINES FOR THE CONVEYANCE OF GOODS AND MINERALS.

TREVITHICK is undoubtedly the “father of the locomotive”; he employed high-pressure steam. He found by experience that flat wheels had sufficient

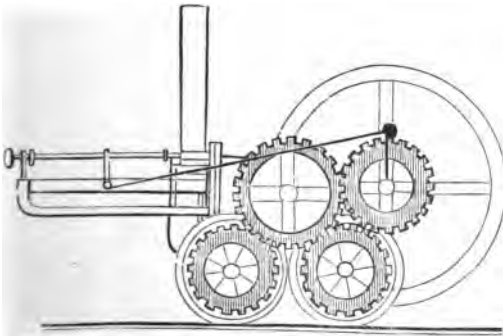

Fig. 1.—The First Locomotive, 1803.

adhesion upon smooth rails, and he conveyed the exhaust steam from the cylinder to the chimney by means of a pipe, which he turned upwards, and dis-

covered, by observing the practical result, that the blast of steam caused the fire to burn much better; he therefore called it the "blast-pipe." This engine ran upon four wheels, 4 feet 6 inches diameter, the boiler was 6 feet in length, and contained a return flue-tube, the chimney being consequently at the same end as the fire-door; the engine had one cylinder placed horizontally, 8 inches diameter, the stroke being no less than 4 feet 6 inches.

On the 24th February, 1804, it was tried upon the Penydarran cast-iron plate-way or tram-road, and conveyed trucks containing ten tons of bar iron and about seventy persons to Merthyr Tydvil, a distance of nine miles. The engine worked satisfactorily from a mechanical point of view, but commercially it was not regarded as a success, being more expensive than horse traction.

Trevithick does not appear to have followed up the development of the locomotive, but left to others the perfecting of those excellent principles which he introduced and discovered; probably it is on this account that he never has received the credit to which he was justly entitled for the construction of the first locomotive which ever ran upon rails.

During the early part of the year 1811, Mr. John Blenkinsop, the proprietor of the Middleton Colliery, near Leeds, decided to convey the coal over his tram-road to that town by means of locomotive engines instead of by horses, and gave an order to Matthew Murray, an engineer, of Leeds, to commence the construction of such an engine. Both Blenkinsop and Murray were under the impression that suffi-

cient adhesion could not be obtained between smooth wheels and smooth rails; and considering the gradients, loads required, and weight of their engine, which was only intended to be five tons, it is probable that their impression was correct. Mr. Blenkinsop, in April, 1811, took out a patent for a rack-rail and cogwheel driving-gear. The engine was completed by Murray, and ran its first trip upon the Middleton line in August, 1812, and at once commenced to convey coal daily from Middleton to the wharf at Great Wilson and Kidacre Streets, Leeds, the distance being about three-and-a-half miles.

The engine was named "Blenkinsop," and ran upon four supporting wheels of 3 feet 6 inches diameter, but they took no part in the driving of the engine. The boiler contained a flue-tube, 20 inches in diameter, having

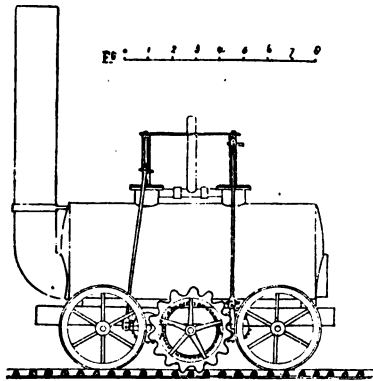

Fig. 2.—"Blenkinsop," 1812.

the fire-grate at one end and the chimney at the other. Two cylinders were employed, 8 in. in diameter, the stroke being 20 inches; the cylinders were placed vertically half within the boiler.

The connecting-rods conveyed motion to cranks, and by means of spur-wheels and gear communicated motion to the main cog or driving-wheel; that wheel

was placed outside the smooth or running part of the rail, and engaged with the outside rack on the rail. Murray placed the two cranks at right angles to each other, thus insuring that one piston was exerting its greatest power when the other was at the end of its stroke. This engine, and others which followed, worked well for many years, and were also a *complete commercial success*. The "Blenkinsop" evaporated eight cubic feet of water per hour, consumed 75 lbs. of coal per hour, and was capable of conveying 94 tons on the level at $3\frac{1}{2}$ miles an hour; its maximum speed being found to be about 10 miles an hour with a gross load of 20 tons.

Messrs. Chapman, in December, 1811, obtained a patent for a method of working the locomotive engine by means of a chain stretched along the whole length of a tram-road, and secured at each end; this chain was in connection with a grooved pulley upon the engine, consequently when this pulley was put in motion, the engine wound itself along the chain; in fact Chapman's chain acted the same purpose as Blenkinsop and Murray's rack-rail. Chapman's system was tried upon the Hetton Colliery tram-road, near Newcastle-on-Tyne, but in a very few weeks proved a complete failure.

Mr. Blckett, of the Wylam Colliery, near Newcastle-on-Tyne, encouraged by the fact that Blenkinsop's engine was a commercial success and conveyed coal at a cheaper rate than horses, decided to make experiments of his own in the same direction. Mr. Blckett and his coal viewer, William Hedley, having made themselves acquainted with the working of the rack-rail system at Leeds, found that to adopt the

Blenkinsop engine would require the Wylam line to be relaid with rack-rails at very great cost. They therefore turned their attention to Trevithick's engine of 1803 (Fig. 1), and ultimately Mr. Blackett remarked, “If Trevithick obtained adhesion with smooth wheels on smooth rails, I can.” To test the question, Blackett and Hedley constructed a frame upon four wheels provided with spur-gear and cranks to be worked by hand, and when this apparatus was tried on the Wylam railway, October, 1812, it was found that the smooth wheels gave the necessary adhesion.

Blackett at once gave orders to Hedley to place a boiler upon this frame, and attach connecting-rods to the hand-crank; in fact to turn the test frame into a locomotive. Hedley did so, and the new engine was tried on the Wylam line, February, 1813, but it was short of steam and proved a failure; the reason being that it was not provided with Trevithick's blast-pipe.

In spite of this failure Mr. Blackett had great faith in steam power, and instructed Hedley to pull off all the top part of the engine, and construct a new boiler and cylinders. The engine, as rebuilt, was completed in May, 1813, and tried on the Wylam line. It had a wrought-iron boiler, with a return flue, the chimney being placed at the same end as the fire-door (as in Trevithick's engine); it had two vertical cylinders, the piston-rods being connected to beams, from which motion was communicated to the four smooth driving wheels by means of toothed-gear; the exhaust steam from the cylinders was discharged by two blast-pipes into the chimney, and it was on account of the “puffing” noise caused by these blast-pipes that the engine was named “Puffing Billy.” (Fig. 3).

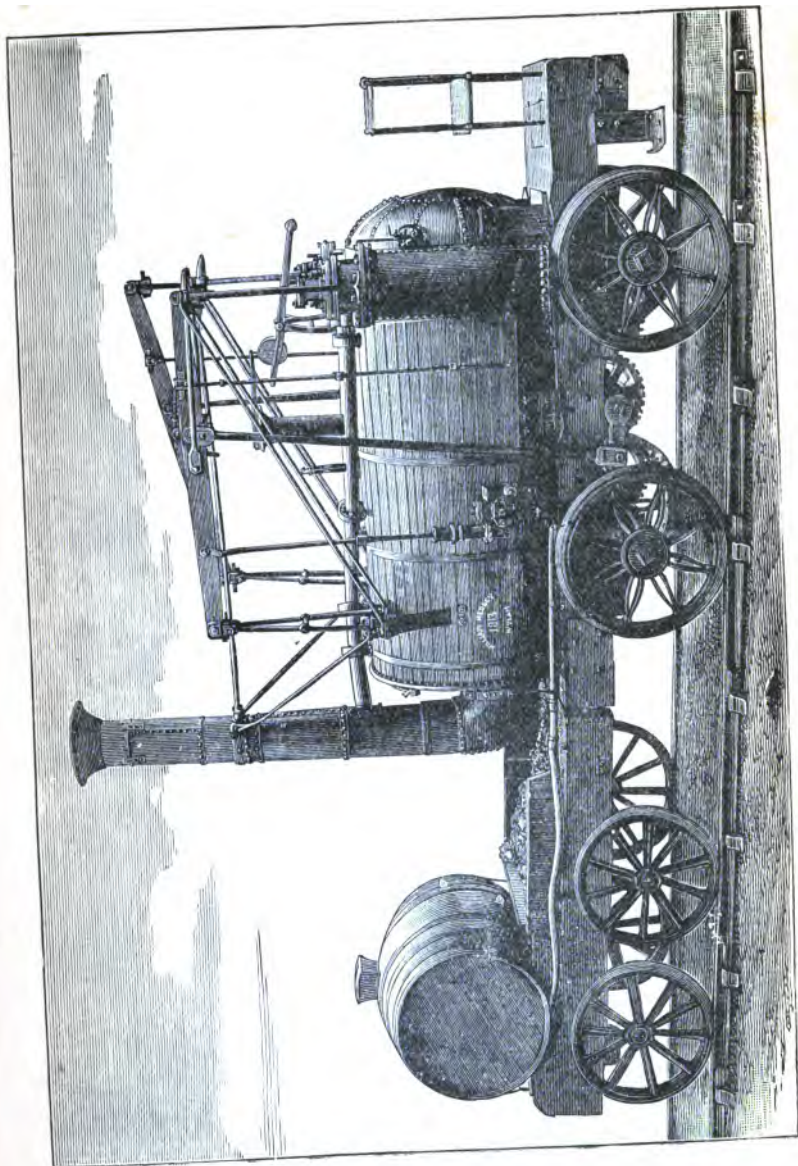

Fig. 3.—“Puffing Billy,” 1813.

A second engine, similar in every respect to Fig. 3, was at once built, and was named the "Wylam Dilly." Mr. Blackett therefore in 1813 had two locomotives which were successful, so far as conveying coal cheaper than horse-power, but he had by no means arrived at the end of his troubles, as will be seen, page 16.

Mr. Brunton, of the Butterley Ironworks, Derbyshire, obtained a patent, in 1813, for a mode of accomplishing the locomotion of an engine without the aid of the adhesion of the wheels; it was, in fact, a "steam horse," having a pair of hind legs actuated by steam cylinders. It is hardly neces-

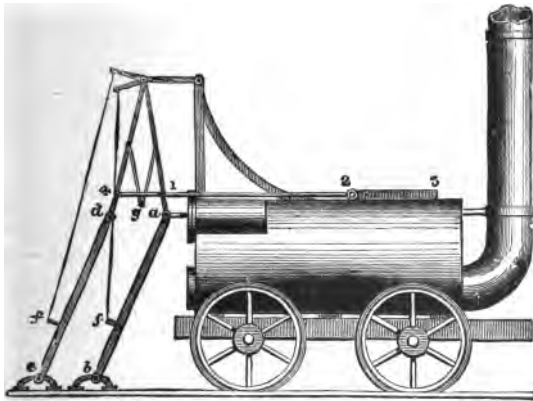

Fig. 4.—"Brunton's Engine," 1813.

sary to say that the arrangement proved a complete failure.

During the time that Blackett and Hedley were engaged at Wylam, Lord Ravensworth and the partners in the Killingworth Colliery, and their engine-wright,

George Stephenson, were anxiously studying the subject at Killingworth. Towards the close of the year 1813 Stephenson designed his first engine, and was at once entrusted by Lord Ravensworth and partners with money to construct a locomotive for their railway. The engine was built at the West Moor workshops of the colliery, and after being under

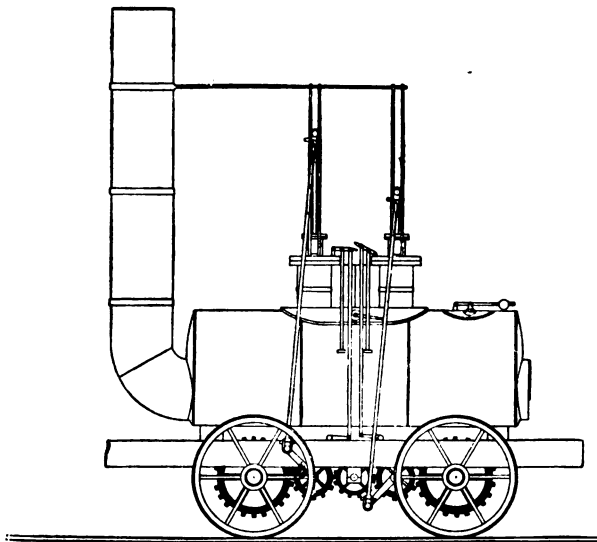

Fig. 5.—George Stephenson's First Engine, 1814.

construction for about ten months, was placed upon the Killingworth railway and tried for the first time on 25th July, 1814, being named or generally known as "Blucher." (Fig. 5.)

This engine ran upon four smooth wheels of 3 feet diameter, placed at a distance of 5 feet apart between

centres. The boiler was 8 feet long, 34 inches diameter, having a flue-tube passing through it, 20 inches diameter. The cylinders were 8 inches diameter, 24 inches stroke, and placed vertically, half within the boiler. The power of the two cylinders was communicated by cross beams and connecting-rods to cranks on the spindles of spur-wheels, which spur-wheels in turn actuated the large cog-wheels on the engine-axles. The small central spur-wheel was employed to maintain the cranks at right angles to each other.

The engine "Blucher," on the 27th of July, 1814, conveyed a train of eight waggons of coal, weighing 30 tons, up a gradient of 1 in 450, at a speed of four miles an hour, and afterwards continued in daily work. This engine was not provided with springs, and the cog-wheel gear becoming worn, Stephenson was entrusted with money to construct a second engine; it was built in 1815, under the protection of a patent granted to Stephenson and Dodd, 28th February, 1815.

In this second engine of Stephenson's the connecting-rods were attached directly to crank-pins upon the wheels, the exhaust steam was discharged into the chimney by two blast-pipes, and the four wheels were coupled together by rods. These coupling-rods, however, were not placed upon the crank-pins outside the wheels, but two double-cranked axles were employed having the cranks at right angles to each other, the two coupling-rods were therefore placed upon these inside cranks, between the wheels. In consequence of one of the crank-axles becoming bent, Stephenson abandoned the arrangement of inside coupling-rods, and

adopted an endless chain passing over a toothed wheel upon each axle.

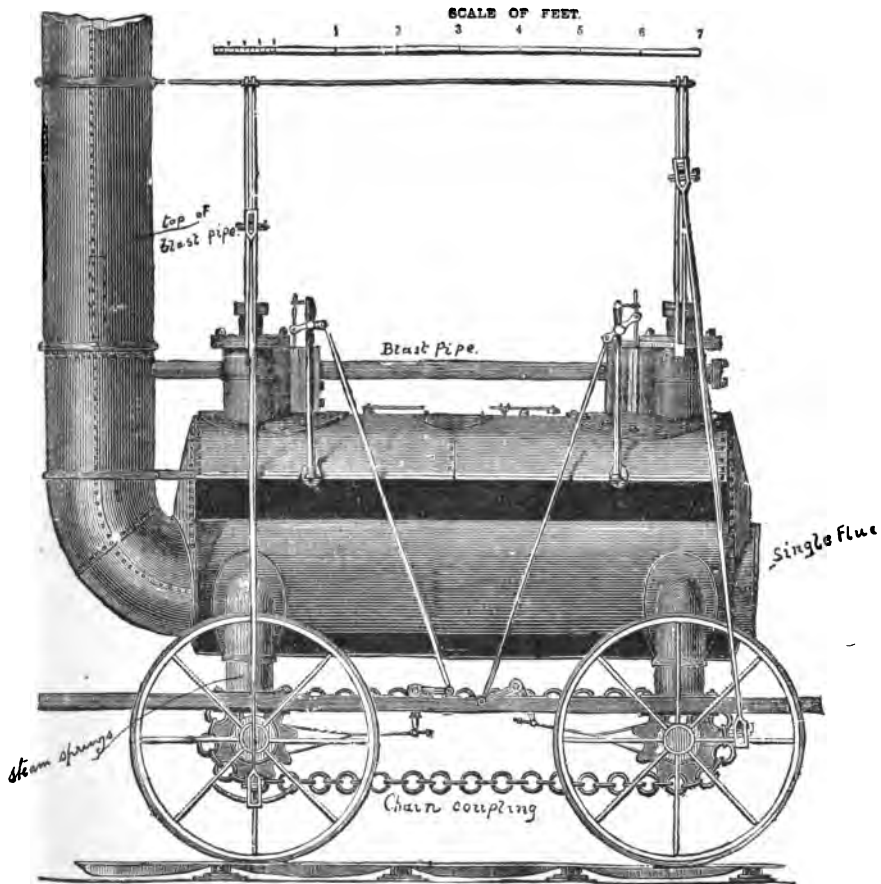

Fig. 6.—George Stephenson's Killingworth Engine, 1816.

George Stephenson constructed for the Killingworth railway a third engine (Figs. 6 and 7), which was

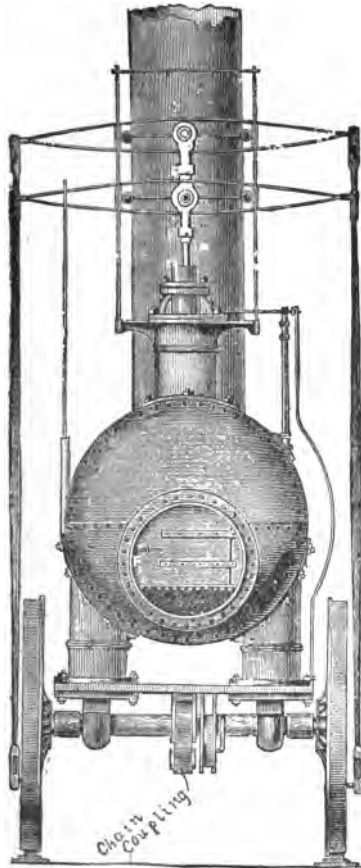

Fig. 7.—End view, Stephenson's Engine, 1816.

provided with steam springs, protected by the Losh and Stephenson patent of September, 1816.

In the illustration (Fig. 6) a portion of the boiler side is supposed to be removed in order to show the single fire-flue. The steam springs, chain system of coupling the wheels, and the blast-pipe are all clearly illustrated.

“Puffing Billy” (Fig. 3) and “Wylam Dilly” rested upon four wheels only, and their weight broke the Wylam cast-iron plate rails to such an extent, that it became necessary to carry half-a-dozen rails upon each engine, to replace those which might break on the journey. The owners of land in the district complained of the noise caused by the blast-pipes, and took counsel’s opinion whether the lease of the land for the colliery railway was not vitiated by the noise of the exhaust steam from the chimney frightening the cattle grazing near the line.

To prevent the breaking of the rails Blackett and Hedley placed their engines upon eight wheels, and in order to pass round the curves they put the wheels under two frames; in other words they placed each of their engines upon two *four-wheeled bogies!* and to overcome the blast-pipe difficulty they placed a cylindrical reservoir “S” between the cylinders and the chimney, in order that the steam might escape gradually and without noise by means of the pipe “R.”

The first of these engines thus altered, or rebuilt, is here illustrated as it was in 1815 (Fig. 8).

The Wylam railway having been re-laid, the engines were again returned to four-wheeled locomotives in 1830.

“Puffing Billy” remained at work upon the Wylam

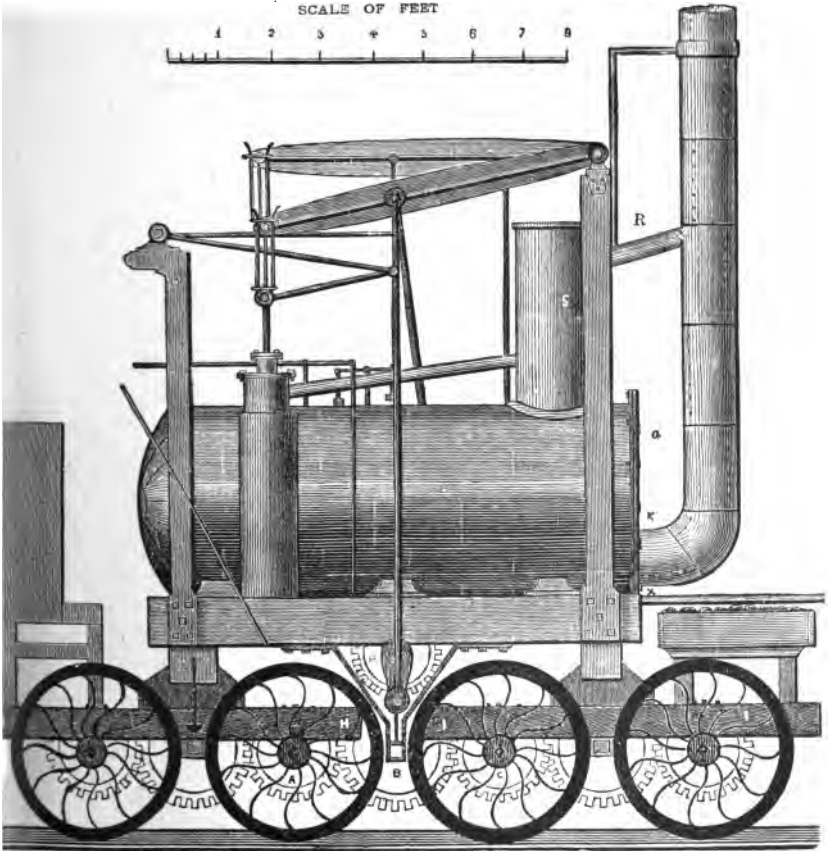

Fig. 8.—“Puffing Billy,” as rebuilt 1815.

line till 1862, when it was removed to the South

Kensington Museum; the "Wylam Dilly" is still preserved in the Edinburgh Museum.

The Duke of Portland, in 1817, ordered an engine from George Stephenson, similar in every respect to Fig. 6, for use upon his Kilmarnock and Troon tram-road. The engine worked the coal traffic from the collieries to the Troon harbour successfully, but its use was afterwards given up, as the cast-iron tram-plates proved too weak to carry any engine.

The owners of Hetton Colliery, near Sunderland, having seen the satisfactory working of Stephenson's locomotives upon the Killingworth line, decided, in 1819, to alter their old "horse tram-road" into a locomotive railway, and they employed George Stephenson as engineer, to lay out the line for them, and to construct the engines. At the opening of the Hetton railway on the 18th November, 1822, there were five of Stephenson's engines at work thereon, similar in design to Fig. 6.

CHAPTER II.

ENGINES EMPLOYED UPON PUBLIC RAILWAYS FOR THE CONVEYANCE OF PASSENGERS, GOODS, AND MINERALS.

Thus far, it will be observed, locomotive engines had simply been employed by private colliery owners for conveyance of coal upon their own lines. The Stockton and Darlington "Public Railway" scheme was therefore one of the important turning points in locomotive history. George Stephenson was appointed engineer, and application was made to Parliament in 1818. Twice the bill was rejected, but it passed in 1821, and on Tuesday, 27th September, 1825, this, the first public railway in the world, was opened for traffic. The engine which drew the first train, and, in fact, the only engine the company at that date possessed, was constructed by Messrs. Stephenson & Co., for the Stockton and Darlington line, in 1825, and was named "Locomotion." The handbill issued September, 1825, announcing the intended opening of the first public railway, proudly and emphatically describes "Locomotion" as "The Company's Locomotive Engine and the Engine's Tender."

This engine ran upon four wheels, had one large flue, or tube, through the boiler, the cylinders being placed vertically and half within the boiler; the

exhaust steam from the cylinders was discharged into the chimney by two blast-pipes, one for each cylinder, that one for the left-hand side being plainly shown in Fig. 9. The boiler, which was worked at a pressure of 25 lbs. per square inch, is 10 feet long by 4 feet diameter, and has 60 square feet of heating surface. The two vertical cylinders are 10 inches diameter, and the stroke 24 inches; the piston-rods being guided by parallel motions. By means of a cross-head and

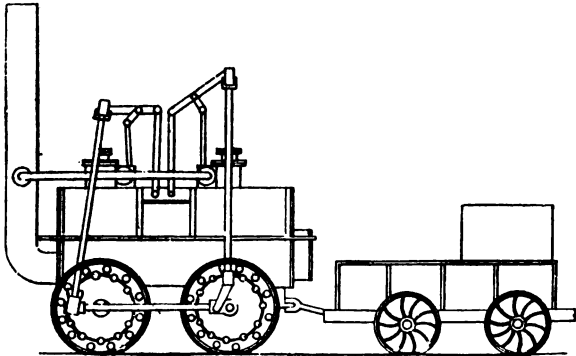

Fig. 9.—Stockton and Darlington Railway. "Locomotion," No. 1, 1825.

pair of connecting-rods the piston of the front cylinder is coupled to the crank-pins upon the leading wheels, the other piston being similarly coupled to the trailing wheels, while outside return cranks on the latter wheels enable the two pairs of wheels to be coupled with the main cranks at right angles. The wheels are 4 feet diameter, and the weight of the engine in working order is 6 tons 10 cwts. It was built at a cost of £600, and its speed was from six to eight miles an hour.

The tender ran upon four wheels of 2 feet 6 inches diameter, the frame being of wood, upon which is mounted a sheet-iron tank holding 240 gallons of water, the coal space being 15 cwts. Weight of tender in working order $2\frac{1}{4}$ tons.

“Locomotion” worked upon the Stockton and Darlington line from 27th September, 1825, to 1841, and after its retirement from active service it was placed upon a pedestal at the entrance to the North Road Station, Darlington, and in April, 1892, it was removed to Bank Top, Darlington. It is still in good working order, and capable of being put in steam. It headed the procession on the opening of the Middlesbrough and Redcar Railway; it was taken from its pedestal and worked upon the Darlington section of the North Eastern Railway, at the Stockton and Darlington Jubilee, September of 1875; it was sent to the Philadelphia Exhibition of 1876, to the “Stephenson Centenary” of 1881, the Liverpool Exhibition of 1886, and it engaged very considerable attention at the Paris Exhibition of 1889.

The following is a copy of the official list of the early Stockton and Darlington locomotives, dated 1836:—

No.	Name of Engine.	Date.	Designed by	Name of Builder.
1	Locomotion....	1825	Stephenson & Co.	Stephenson & Co.
2	Hope	1826	“	“
3	Black Diamond.	“	“	“
4	Diligence.....	“	“	“
5	Royal George*.	1827	T. Hackworth ..	Rebuilt Rlway Co.'s Works, Shildon.
6	Experiment....	1826	Stephenson & Co.	Stephenson & Co.
7	Rocket.....	1829	“	“
8	Victory	“	T. Hackworth ...	Railway Co.'s Works, Shildon.

* No. 5 was built by Messrs. Wilson & Co., 1826, and rebuilt by the Company's locomotive foreman, T. Hackworth, October, 1827.

No.	Name of Engine.	Date	Designed by	Name of Builder.
9	Globe	1830	T. Hackworth ..	Stephenson & Co.
10	Planet	"	Stephenson & Co.	"
11	North Star	"	"	"
12	Majestic	1831	T. Hackworth ..	Railway Co.'s Works, Shildon.
12	Coronation	"	"	Hawthorn & Co.
14	William IV.....	"	"	Railway Co.'s Works, Shildon.
15	Northumbrian..	"	"	Railway Co.'s Works, Shildon
16	Director	1832	"	Stephenson & Co.
17	Lord Brougham	"	"	Railway Co.'s Works, Shildon.
18	Shildon.....	"	"	Railway Co.'s Works, Shildon.
19	Darlington	"	"	Hawthorn & Co.
20	Adelaide.....	"	"	Stephenson & Co.
21	Earl Grey.....	"	"	Hawthorn & Co.
22	Lord Durham..	"	"	Stephenson & Co.
23	Wilberforce....	"	"	Hawthorn & Co.
24	Magnet.....	"	"	Railway Co.'s Works, Shildon.
25	Enterprise.....	1833	Kitching.....	Kitching.
26	Swift.....	1836	Hawthorn & Co..	Hawthorn & Co.

Following the opening of the Stockton and Darlington Railway, Stephenson constructed for it three other engines of similar design to "Locomotion;" and Mr. Timothy Hackworth became engine superintendent.

During the early part of the year 1826, Messrs. Wilson & Co., of Newcastle, designed and constructed an engine, No. 5, for the Stockton and Darlington Railway, and as that firm considered outside coupling-rods an objection, they placed their engine upon four wheels, and employed four cylinders, two to each pair. Thus it had two pairs of independent driving-wheels.

Messrs. Stephenson & Co., early in the year 1826, designed and built "Experiment," No. 6 (Fig. 10), for the Stockton and Darlington line; it had outside inclined cylinders, 9 inches diameter; stroke 24 inches; wheels 4 feet diameter, boiler 10 feet

long by 4 feet diameter. The boiler contained two fire-flue tubes, 18 inches diameter. The exhaust steam was conveyed from the cylinders to the chimney by two blast-pipes, one for each cylinder.

“Twin Sisters” (Fig. 11) was built by Stephenson & Co., in 1827, as a contractor’s locomotive at the making of the Liverpool and Manchester Railway, and as it was required to work over very severe temporary

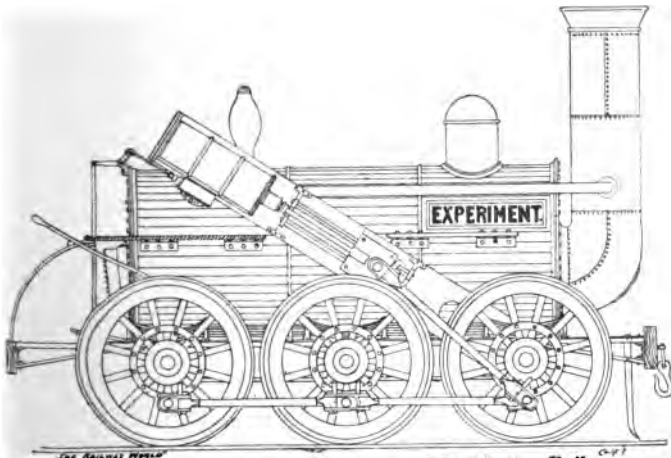

Fig. 10.—“Experiment,” Stockton and Darlington Railway, No. 6, 1826.

gradients it was considered best to construct it with twin boilers, in order to insure that water should at all times cover the tops of the fire-boxes.

This engine ran upon six coupled wheels of 4 feet diameter, the cylinders being placed outside, in an inclined position ; two blast-pipes were employed, one for each cylinder. After the completion of the Liverpool and Manchester Railway, “Twin Sisters” became

known as the "Liverpool Coke Engine," from the fact that it was employed to work trains of coke to that city for Mr. Hulton, who contracted to supply the railway company with locomotive fuel.

The four-cylinder engine, No. 5, for the Stockton and Darlington Railway (mentioned on page 22), having worked very unsatisfactorily, and also having been very seriously damaged in a collision at Stock-

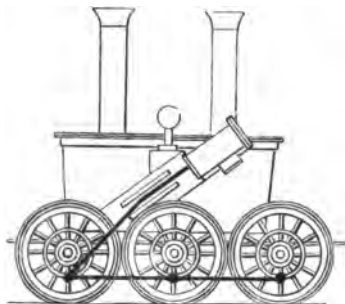

Fig. 11.—"Twin Sisters," Ballast Engine, 1827.

ton, Timothy Hackworth, in 1827, obtained the authority of the directors to remodel and rebuild it. The boiler was 13 feet long, and 4 feet diameter, and

into this Hackworth introduced a return flue-tube, similar to those previously employed by Trevithick and by Hedley.



Fig. 12.—"Royal George." Rebuilt, 1827.

The engine thus rebuilt at the Company's Shildon Works was named the "Royal George," No. 5, and

commenced work October, 1827. (Fig. 12.)

The "Royal George" had six coupled wheels of 4 feet diameter, outside vertical cylinders 11 inches

diameter, the stroke being 20 inches. The fire-door and chimney were both at the same end, consequently two tenders were provided, one at each end of the engine; the exhaust steam was discharged into the chimney by one blast-pipe for both cylinders.

The maximum performance of the “Royal George” was drawing 32 waggons of coal weighing 130 tons at five miles an hour on the level and nine miles an

hour on falling gradients. Weight of engine and its two tenders in working order, 15 tons. The “Royal George” worked regularly upon the Stockton and Darlington line from 1827 to 1842.

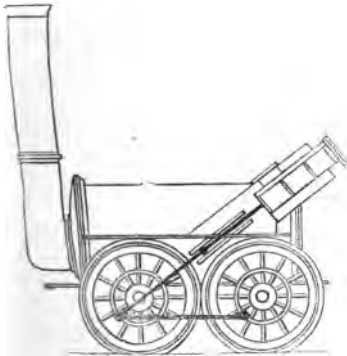

Fig. 13.—“Lancashire Witch,” Bolton and Leigh Railway, 1828.

Stephenson & Co. in 1828 constructed a four-wheeled coupled engine named the “Lancashire Witch,”

for the Bolton and Leigh Railway. (Fig. 13.)

Cylinders	9 in. diameter.
Stroke	24 in.
Diameter of wheels	4 ft.
Boiler	9 ft. long.
Boiler	4 ft. diameter.
The boiler contained two fire-tubes or flues	1 ft. 6 in. diameter.
Heating surface of flues	66 sq. feet.
Four-wheeled tender.	

The “Lancashire Witch” was employed first as a ballast engine at the construction of the Bolton and Leigh line, and it was found by experiment that this

engine conveyed 53 tons up a gradient of 1 in 432 at

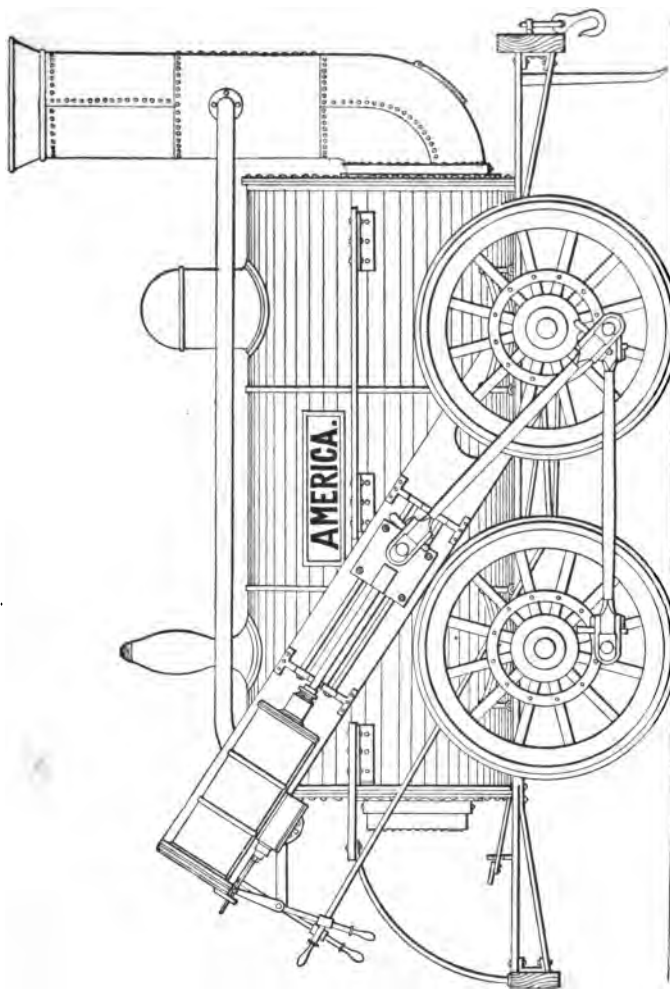

Fig. 14.—The First Locomotive for America, 1828.

a speed of $8\frac{8}{10}$ miles an hour ; it afterwards continued to work traffic for several years.

Early in the year 1828 the Delaware and Hudson Canal Company, having heard of the success of the Stockton and Darlington Railway, sent over Mr. Horatio Allen to England with instructions to obtain information and purchase rails and four locomotives. He gave an order to Messrs. Foster, Rastrick & Co., of Stourbridge, for three, also to Mr. Stephenson for one.

Stephenson's engine was named "America"; it was built in 1828, and arrived in New York, on board the ship "Columbia," about the middle of January, 1829. It was the first railroad locomotive ever seen in America, and is here illustrated. (Fig. 14.)

The following is the copy of the official description of locomotive engine "America," built by R. Stephenson & Co. for the Delaware and Hudson Canal Company, to the order of Mr. Horatio Allen, 1828, and No. 12 in the books of the makers:—

Diameter of boiler	Ft. Ina.
Length " "	4 1
Dimensions of fireplace	9 6
Diameter of steam cylinders	4ft. 0in. by 3 0
Length of stroke	0 9
Size of chimney	2 0
Size of hot-water pump	1 8
Length of pump stroke	0 1½
Wheels (wood) diameter	2 0
Number of wheels 4	4 0
Angle of cylinders to the horizontal 33°	
Size of tubes	1 7
Number of fire tubes 2. Tubes were straight.	

Some persons have contended that the iron-bar-framing in general use in the United States was an American invention, but reference to the illustration, Fig 14, proves conclusively that the "bar-frame"

was sent from this country. Although Stephenson's engine was the *first* to arrive, it was not the first to be run.

Messrs. Foster & Rastrick's engine, the "Stourbridge Lion" was built 1828, and arrived in New York May, 1829, but neither of the engines for America could be put to work for some months as the railway was not completed. Messrs. Foster & Rastrick's engine, the "Stourbridge Lion," was the first locomotive which ever ran upon rails in America; it was tried for the first time on 9th August, 1829, being driven by Horatio Allen upon a section of the Delaware and Hudson Canal Company's Railroad. The "Stourbridge Lion" was exactly similar to Fig. 15, but with a much shorter chimney. It is still preserved, and was exhibited at the Chicago Railway Exposition of 1884.

Messrs. Foster, Rastrick & Co. in 1829 constructed an engine (Fig. 15) for the Shutt End Railway, which extends from the Earl of Dudley's Colliery at Kingswinford, to the Staffordshire and Worcestershire Canal; this locomotive was named "Agenoria," and opened the line on Tuesday, June 2nd, 1829.

This engine has upright cylinders working half beams, thus reducing the stroke of the pistons to the cranks. The cylinders are $7\frac{1}{2}$ inches diameter, with a stroke of 3 feet. There is a parallel motion to the piston-rod, and the feed-pump is worked from one of the half beams. The fire-grate is within a large tubular boiler, branching into two tubes, with the chimney at the end of the boiler, the barrel of the boiler being 10 feet long and 4 feet diameter. The eccentrics for driving the slide-valves are loose upon the axle, with a

clutch to drive either way, and there is hand-gear to the valves to cause the axle to turn half round to bring the required backward or forward clutch into action. The exhaust steam is discharged into the chimney,

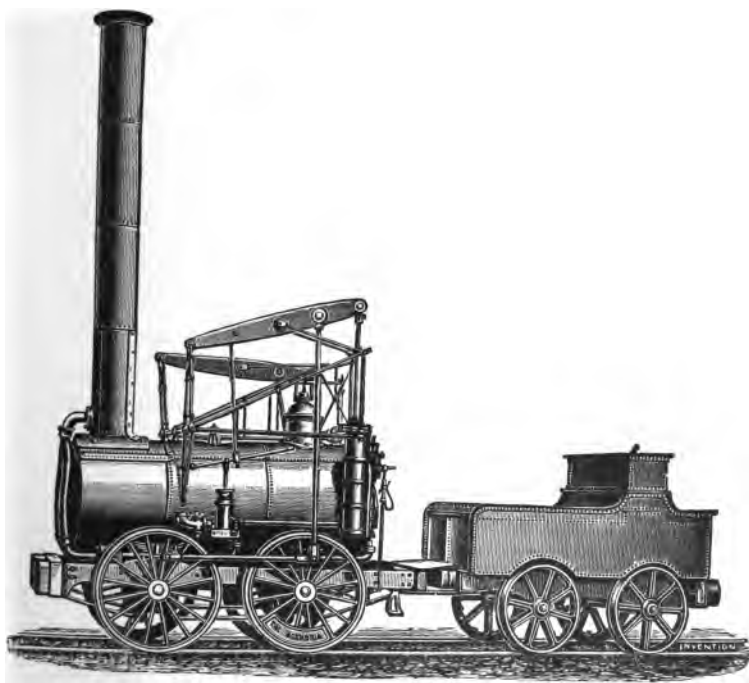

Fig. 15.—“Agenoria,” Shutt End Railway, 1829.

which, it may be mentioned, is of unusual height. “Agenoria” continued in regular work for fully 30 years, and is now preserved in the South Kensington Museum.

The Liverpool and Manchester has been truly

designated "The Grand British Experimental Railway." George Stephenson was appointed engineer, and the line was publicly opened 15th September, 1830.

Some time previously to the opening the question of locomotive or fixed engines and ropes naturally came before the directors, as it was necessary to arrange for "power" to work the traffic; they therefore decided to employ Messrs. Walker and Rastrick, engineers, to make a tour of inspection to examine all the railways then at work; but, notwithstanding the reports, the directors did not feel able to come to a decision, when one of their number, Mr. Harrison, proposed "that a reward be publicly offered for the most likely mode of effecting their object," and it was resolved to offer a prize of £500 for the best engine.

The trial took place on the Manchester side of Rainhill Bridge, upon a level portion of the line, and lasted from the 8th to the 14th October, 1829. Three engines competed for the prize, namely :

The "Rocket"	by G. and R. Stephenson.
The "Novelty"	by Braithwaite & Ericsson.
The "Sanspareil"	by T. Hackworth.

Each locomotive was required to run ten trips over the trial ground, equal to a journey of thirty-five miles, at full speed, the average rate to be not less than ten miles per hour. At the end of the first ten trips each engine was to be got ready again, and to repeat the test, the object being to prove that the engine would be able to perform a journey from Liverpool to Manchester and back.

The "Rocket" (Fig. 16) satisfactorily performed

all the tests required by the judges, and the prize was consequently awarded to Messrs. Stephenson.

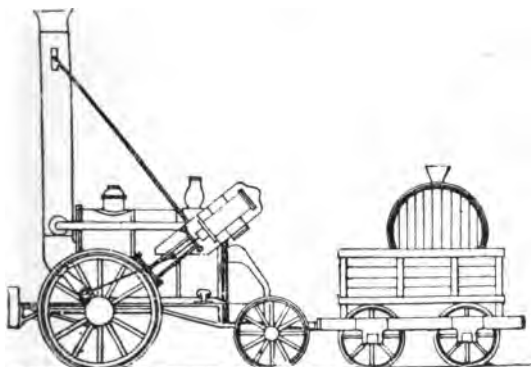

Fig. 16.—“Rocket,” Liverpool and Manchester Railway, 1829.

The dimensions of the “Rocket” were as follows:—

Cylinders, diameter	8 in.
Cylinders, stroke	16½ in.
Driving-wheels, diameter	4 ft. 8½ in.
Boiler	6 ft. long.
Boiler	3 ft. 4 in. diameter.
Pressure of steam in the boiler ..	50 lbs. per sq. inch.
Fire-box	2 ft. long inside.
Fire-box	3 ft. broad inside.
Fire-box	3 ft. deep inside.
Tubes, number	25.
Tubes, diameter	3 in.
Tubes, heating surface	117·75 square feet.
Fire-box, heating surface	20 square feet.
Total	137·75 square feet.
Area of fire-grate	6 square feet.
Weight of engine in working trim	4 tons 5 cwts.
Weight of tender, loaded	3 tons 4 cwts.
Total	7 tons 9 cwts.

The maximum speed attained by the “Rocket” at the Rainhill trials was 29 miles an hour. This engine

although crude in appearance, possessed all those essential features which are necessary to the success of a locomotive—namely, the tubular boiler, direct connection between the piston and the crank-pin on the driving-wheel, and blast-pipes in the chimney, there being one pipe for each cylinder, as in the engine of 1815, and the "Locomotion" of 1825.

So little progress had the locomotive engine made in public favour, that even in the year 1829 the directors of the Liverpool and Manchester Railway were divided in opinion as to fixed engines and ropes, horses and locomotives, and had not the locomotive engine proved itself a success at Rainhill, the result would have been the introduction of other means of working that line. It will therefore be seen that although George Stephenson was not, and of course never claimed to be, the inventor of the locomotive, still he it was who in 1829, at Rainhill, settled the question and made the locomotive a practical success, and thereby led to the introduction of railways throughout the world. It is hardly necessary to mention that the celebrated "Rocket" is preserved in the South Kensington Museum, and it may be added that the "Rocket" and "Sanspareil" have lately been placed upon some of the old original Liverpool and Manchester rails of 1829 which have been presented to that institution by the author for the purpose, and the full-sized models of these engines at the Chicago Exhibition stood upon similar old rails.

The "Novelty," constructed by Messrs. Braithwaite and Ericsson, ran upon four wheels, and had a combined vertical and horizontal boiler; and bellows were employed to force air through the fire. In this engine, motion was communicated from the piston-rod to the

wheels by means of a bell-crank. The "Novelty" broke down and failed at Rainhill.

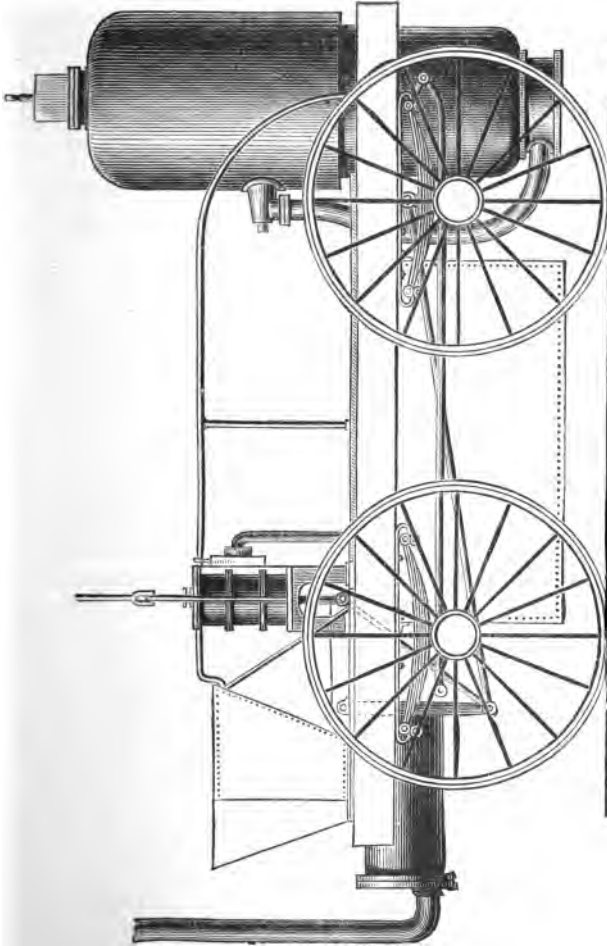

Fig. 17.—The "Novelty," 1825.

The "Sanspareil" was designed and constructed by

D

Timothy Hackworth, the engine superintendent of the Stockton and Darlington line, for the Rainhill competition. It ran upon four coupled wheels of 4 feet 6 inches diameter. The boiler was 6 feet long, and 4 feet 2 inches diameter, containing a return flue-tube, the chimney being placed at the same end of the engine as the fire-door. The cylinders were 7 inches diameter, and the stroke 18 inches, placed vertically one on each side of the boiler, immediately above one of the pairs of wheels; the exhaust steam from the cylinders was discharged into the chimney by a blast-pipe, similar to that of Trevithick's 1803.

When the "Sanspareil" was brought forward for trial at Rainhill, the judges found that it did not comply with the conditions issued, being of greater weight than was to be allowed to be placed upon four wheels, the engine therefore should have been upon six wheels. Strictly speaking, it was considered that Hackworth's engine was therefore excluded from competing for the prize, but the judges wisely decided to put the engine to the same trial as the others. However, it broke down and failed to obtain the prize. The "Sanspareil" worked upon the Bolton and Leigh Railway until 1844, and is now placed in the South Kensington Museum.

At the conclusion of the Rainhill trials and the victory of the "Rocket," Stephenson received orders to build seven other engines, to be ready for the opening of the Liverpool and Manchester Railway. They were constructed during the year 1830, and were very similar in design to the Rocket; they were named "Meteor," "Comet," "Arrow," "Dart," "Phoenix," "North Star," and "Northumbrian;" they all had outside cylinders and the driving wheels in front.

The Canterbury and Whitstable Railway was opened on the 3rd May, 1830, the first train being worked by the Company’s only locomotive, which had been built by Stephenson & Co., and was named “Invicta.” (Fig. 18.)

Cylinders	10 ins. diameter.
Stroke	18 ins.
Boiler barrel	8 ft. long.
Boiler	3 ft. 4 ins. diam.
Pressure	40 lbs. per square inch.
Wheels	4 ft. diameter.
Wheel-base	4 ft. 7 in.
The boiler contained 25 tubes, 3 ins. diameter.	
The tender ran on four wheels.	

This ancient engine is preserved by the South-Eastern Railway Company at Ashford ; it was sent to the Darlington Jubilee, 1875, and to the George Stephenson Centenary, 1881.

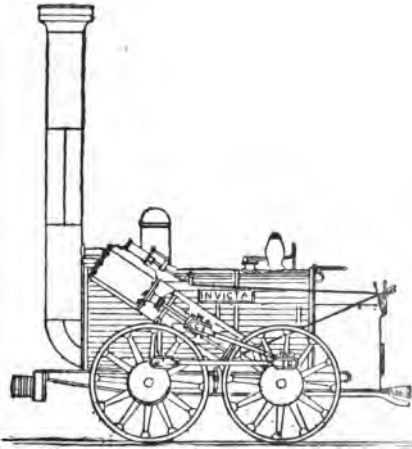

Fig. 18.—“Invicta,” Canterbury and Whitstable Railway, 1830. Makers’ No. 20.

The Liverpool and Manchester Railway was opened on 15th September, 1830, upon which occasion the Company’s eight engines and trains, and about 600 people, started in a procession from Liverpool in the following order :—

Name of Engine.	Driven by
“Northumbrian”	George Stephenson.
“Phoenix”	Robert Stephenson.
“North Star”	R. Stephenson, Senr. (brother of George).
“Rocket”	Joseph Locke.
“Dart”	Thomas L. Gooch.

Name of Engine.	Driven by
"Comet"	William Allicard.
"Arrow"	Frederick Swanwick.
"Meteor"	Anthony Harding.

Therefore the engine which opened the Liverpool and Manchester Railway was the "Northumbrian" (Fig. 19).

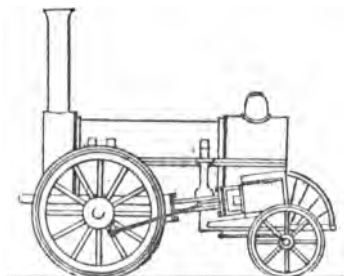

Fig. 19.—"Northumbrian," No. 8, L. & M. Ry., 1830.

The engine, it will be observed, had a smoke-box, and the cylinders were placed outside, nearly horizontally, the driving-wheels, as in the "Rocket" and six other engines named,

were placed in front. The "Northumbrian" had—

Cylinders	11 ins. diameter.
Stroke	16 ins.
Driving-wheels	5 ft. diameter.
Total heating surface	411·75 sq. ft.
Weight in working order	7 tons 6 cwt. 3 qrs.
Weight on driving wheels.. .. .	4 tons 1 qr.

On the opening day, when Mr. Huskisson was knocked down and run over at Parkside by the "Rocket," he was conveyed by the "Northumbrian" to Eccles, 15 miles in 25 minutes, or 36 miles an hour. On 16th September, 1830, when the regular traffic of the line commenced, the "Northumbrian" conveyed a train of 130 passengers from Liverpool to Manchester (Liverpool Road Station), a distance of 30 miles, in an hour and fifty minutes.

The following is a copy of the Company's official list of engines to the year 1834:—

LIVERPOOL AND MANCHESTER RAILWAY COMPANY.—LOCOMOTIVE LIST, 1829 TO 1834. [Conv.]

No.	Name of Engine.	Date.	Maker.	Diam. of cylind-ers.		Length of stroke.	Diam. of driving wheels.		Design.	Remarks.
				Ins.	Ft. In.		Ins.	Ft. In.		
1	Rocket ...	1829	R. Stephenson & Co. ...	8	16½	4	8½	"Rocket" class	4 wheeled engines, outside cylinders, driving wheels in front.	
2	Meteor ...	1830	"	10	16	5	0			
3	Comet ...	"	"	10	16	5	0			
4	Arrow ...	"	"	10	16	5	0			
5	Dart ...	"	"	10	16	5	0			
6	Phoenix ...	"	"	11	16	5	0			
7	North Star ...	"	"	11	16	5	0			
8	Northumbrian ...	"	"	11	16	5	0	"Planet" class	4 wheeled engines, inside cylinders, driving wheels behind	
9	Planet ...	"	"	11	16	5	0			
10	Majestic ...	"	"	11	16	5	0			
11	Mercury ...	"	"	11	16	5	0			
12	Mars ...	"	"	11	16	5	0			
13	Samson ...	1831	"	14	16	4	6			
14	Jupiter ...	"	"	11	16	5	0	"Samson" class "Planet" class	4 wheels coupled.	
15	Goliath ...	"	"	14	16	4	0			
16	Saturn ...	"	"	11	16	5	0			
17	Sun ...	"	"	11	16	5	0			
18	Venus ...	"	"	11	16	5	0			
19	Vulcan ...	"	"	11	16	5	0			
20	Etna ...	"	Fenton, Murray & Co. ...	11	16	5	0	"Samson" "Planet" "Samson" "Planet" class	4 wheels coupled.	
21	Fury ...	"	R. Stephenson & Co. ...	11	16	5	0			
22	Victory ...	"	Fenton, Murray & Co. ...	11	16	5	0			
23	Atlas ...	1832	R. Stephenson & Co. ...	12	16	5	0			
24	Vesta ...	"	"	11	16	5	0			
25	Milo ...	"	"	12	16	5	0			
26	Liver ...	"	"	12	16	5	0	"Samson" "Planet" "Samson" "Bury's" "Planet" (4 coupled) "Planet"	4 wheels coupled.	
27	Pluto ...	"	E. Bury & Co. ...	11	16	5	0			
28	Caledonian ...	"	R. Stephenson & Co. ...	12	16	5	0			
29	Ajax ...	"	Galloway & Co. ...	12	16	5	0			
30	Leeds ...	"	R. Stephenson & Co. ...	11	18	5	0			
31	Firefly ...	1833	R. Stephenson & Co. ...	11	18	5	0			
32	Experiment ...	"	Sharrp, Roberts & Co. ...	11	16	5	0	Roberts' design (6 wheels)	Vertical cylinders. Inside cylinders.	
33	Patentee ...	1834	R. Stephenson & Co. ...	12	18	5	0			
34	Titan ...	"	Tableur & Co. ...	11	20	5	0			
35	Orion ...	"	"	11	20	5	0			
36	Swiftsure ...	"	Forrester & Co. ...	11	18	5	0			
36	Swiftsure ...	"	"	11	18	5	0			"

Dated 1834, Liverpool.

Towards the close of the year 1829 Stephenson completed the design for a new engine for the Liverpool and Manchester Railway, and it was placed upon that line on the 4th October, 1830.

This engine—the “Planet” (Fig. 20)—was a striking improvement upon all Stephenson’s previous ones. The cylinders were placed “inside” under the smoke-box,

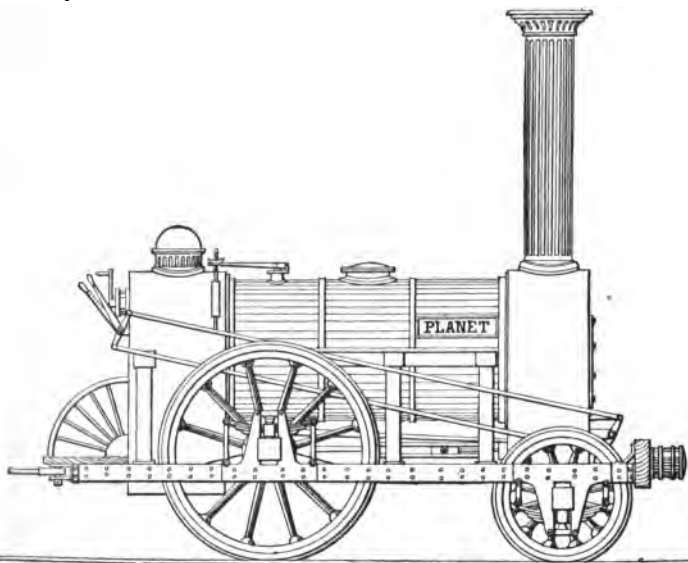

Fig. 20.—“Planet,” No. 9, Liverpool and Manchester Railway, 1830.

the driving-wheels were at the trailing end, and a double-cranked axle was employed, similar to one of those previously used for coupling the engine of 1815. The bar-frame is here abandoned, and an oak-frame employed, plated on both sides with iron: the framing and the axle-boxes were outside the wheels.

Cylinders, 11 ins. diameter; Stroke, 16 ins.; Between centres of cylinders, 2 ft. 6 $\frac{1}{4}$ ins. Leading wheels, 3 ft. diameter.; Driving wheels, 5 ft. diameter.

Boiler	6 ft. 6 ins. long.
Boiler	3 ft. diameter.
129 tubes.. .. .	1½ inches.
Heating surface of tubes	370·41 square feet.
" " firebox	37·25 "
Total	407·66 "
Area of fire-grate	6·50 "
Weight in working trim	8 tons 0 cwt. 0 qrs.
On driving wheels.. .. .	5 " 2 " 2 "

This engine had also the usual four-wheeled tender, which weighed 4 tons fully loaded.

On the 23rd November, 1830, the "Planet" worked a special train to convey voters from Manchester to Liverpool for an election; the official report states that "the time of setting out was delayed, rendering it necessary to use extraordinary despatch, in order to convey the voters to Liverpool in time"—the journey was performed in 60 minutes, including a stop of two minutes on the road for water.

From another official report it is found that between 16th September and 7th December, 1830, the Company's engines conveyed 50,000 passengers, and ran a distance of 28,620 miles, or 954 trips between Liverpool and Manchester and back.

The "Mercury" No. 11 (Fig. 21) was constructed by Stephenson & Co., December, 1830; it was of the "Planet" type, but with the improvement that the frame was raised so as to be *above* the driving-axle.

Stephenson's "Planet" class of engine, as developed in the "Mercury," became the standard pattern of English four-wheeled locomotives, and was copied in America and other countries shortly afterwards. In December, 1833, a small pair of trailing wheels was added, and "Mercury" became a six-wheeled locomotive.

During the year 1830 Mr. Edward Bury built an outside cylinder engine "Dreadnought," and Timothy Hackworth placed the "Globe" upon the Stockton and Darlington Railway having an inside frame, inside cylinders and four coupled wheels.

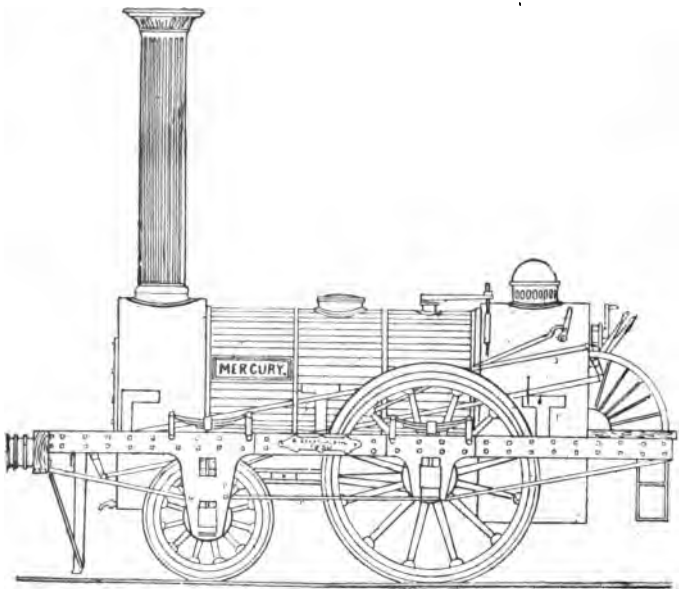

Fig. 21.—"Mercury," No. 11, Liverpool and Manchester Railway, December, 1830.

For the first few months after the opening of the Liverpool and Manchester Railway, some mixed trains of passengers and goods were run daily, drawn by the "single" engines of the "Rocket" and "Planet" classes; but as the goods traffic gradually increased it

became necessary to work goods trains, and Messrs. R. Stephenson & Co., in January, 1831, placed upon the line two goods engines which "had been specially constructed and were described as of extraordinary power;" they were named "Samson," No. 13 (Fig. 22), and "Goliath" (No. 15).

It will be observed, that practically the "Samson" and "Goliath" were a four-wheeled coupled development of the "Mercury" (Fig. 21), having cylinders 14 inches diameter, 16 inches stroke, and coupled wheels 4 feet 6 inches diameter. Total heating surface 457·10 square feet; weight of engine in working order 10 tons.

The "Samson," on 25th February, 1831, "accomplished the great feat," it is officially

recorded, of conveying a goods train of 164 tons (exclusive of weight of engine and tender), from Liverpool to Manchester in two hours and a half—the maximum speed being 20 miles an hour, and the consumption of coke was reduced to about a third of a pound per ton per mile.

During the time the "Samson" and "Goliath" were under construction, another engine of the same class was built by Stephenson for the Hudson and

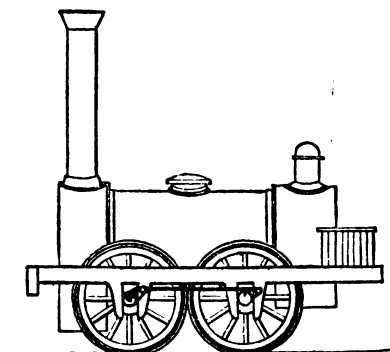

Fig. 22.—"Samson," No. 13, Liverpool and Manchester Railway, January, 1831.

Mohawk Railway, U.S.A., named "John Bull," and it was sent to America in 1831.

The Glasgow and Garnkirk Railway was opened in 1831, the first train being drawn by the Company's engine named "George Stephenson," which had been constructed at Newcastle, and was driven by Mr. George Stephenson upon that occasion.

This engine had cylinders 11 by 16 inches; coupled wheels 4 feet 6 inches diameter; wheel base 4 feet 9 inches. Boiler pressure 50 pounds per square inch.

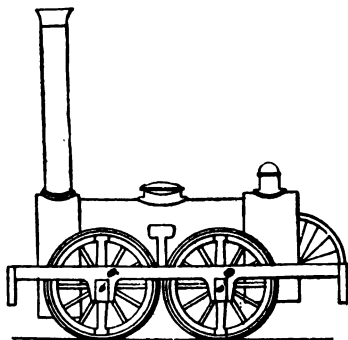

Fig. 23.—"George Stephenson,"
Glasgow and Garnkirk Railway,
1831.

The directors of the Monkland and Kirkin-tilloch Railway (near Glasgow), at the beginning of the year 1831, instructed their engineer, Mr. Dodds, to make out a plan and specification of two locomotive engines, able to drag 60 tons gross weight at the

rate of four or five miles an hour. The engines were built by Messrs. Murdoch and Aitken, Hill Street, Glasgow, the first being tried on the line on May 10th, 1831, and the second on September 10th, 1831. An official report issued to the shareholders stated that the engines were satisfactory.

On January 4th, 1831, the Baltimore and Ohio Railroad Company offered 4,000 dols. premium for the best American locomotive of $3\frac{1}{2}$ tons weight, which should

draw 15 tons at 15 miles an hour on a level. The boiler was to use as fuel anthracite coal; it was to have four wheels, coupled together, 4 feet between centres, in order to pass around curves of 400 feet radius. The steam pressure was not to exceed 100 lbs. to the square inch above the atmosphere. The locomotives were to be delivered for trial upon the road, on or before June 1st, 1831, and the sum of 3,500 dols. was to be paid for the locomotive which should be adjudged to be best.

Three or four locomotives were entered for competition; the prize was awarded to Messrs. Davis and Gartner, of York (Pennsylvania), whose engine was named the "York." The locomotive had a vertical-flue boiler and vertical cylinders, with four coupled wheels, 30 inches in diameter. It was altered considerably after being placed on the road.

The same firm afterwards built another locomotive, named the "Atlantic," being the first of what was known as the "Grasshopper" pattern, which was used for many years on the Baltimore and Ohio Railroad, and some of which engines were in use on that road as recently as 1883, and a few continued in service for a period of fifty years.

During the year 1831, the directors of the Leicester and Swannington Railway gave an order to Messrs. R. Stephenson & Co. for two locomotives. The first of these was named "Comet," being No. 4 in the list of the makers, and No. 1 in that of the railway company. It was shipped by sea from Newcastle to Hull, thence by canal to Leicester, where it was put upon the rails and ran its first trip 5th May, 1832, and after doing some preliminary ballasting, it worked the train, upon the opening of the line, from West Bridge, Leicester, to

Bagworth, driven by George Stephenson himself, assisted by his son Robert, and the regular driver Weatherburn.

The cylinders were 12 by 16 inches, the coupled wheels 5 feet diameter, and the wheel-base 5 feet 3 inches; total length of engine frame 16 feet.

The cylinders were placed low down, the piston-rods passing under the leading axle, and the valves were placed upon the tops of the cylinders.

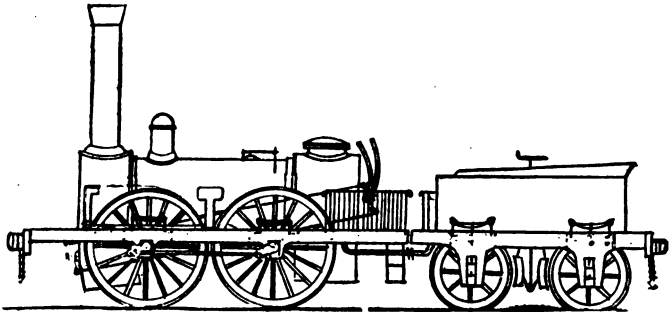
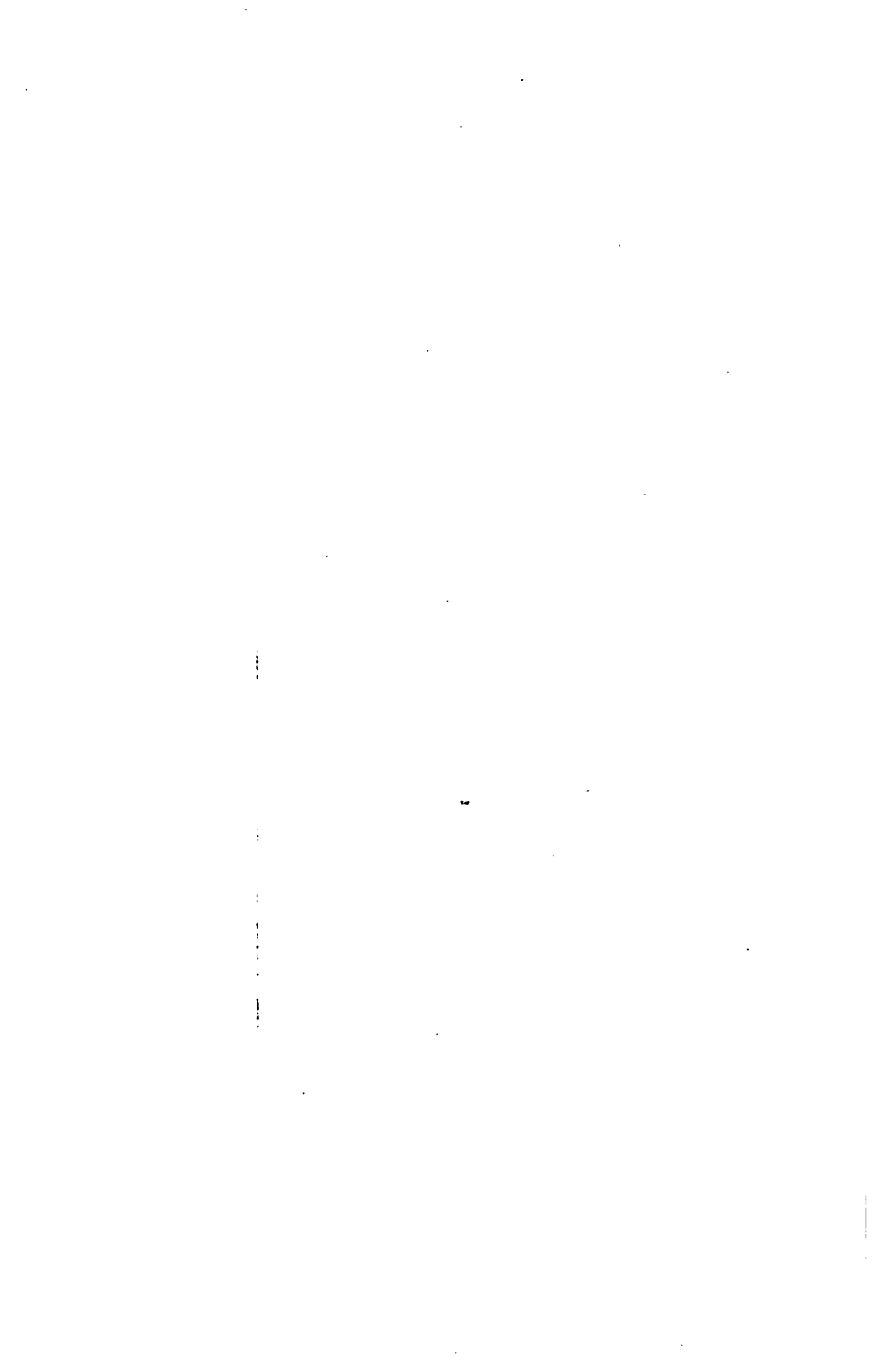

Fig. 24.—“Comet,” No. 1, Leicester and Swannington Railway, May, 1832.

The valve-gear consisted of a single eccentric for each valve, loose upon the driving-axle, motion being communicated by means of studs or “drivers.” These “drivers” were fixed to the crank-axle by collars. When the eccentrics were half-way between the two collars, the axle turned without communicating any movement to them, and the engine was out of gear.

By means of a “treadle” upon the foot-plate, the engineman moved the eccentrics lengthways upon the



REFERENCES TO ILLUSTRATIONS
IN THIS VOLUME:—

(See Fig. 24, p. 44) ..

(See Fig. 25, p. 46) ..

(See Fig. 29, p. 50) ..

(See p. 53)

(See Fig. 33, p. 56) ..

(See Fig. 35, p. 59) ..

(See Fig. 36, p. 61) ..

(See Fig. 39, p. 66) ..

(See Fig. 42, p. 69) ..

(See Fig. 48, p. 79) ..

Railway Co.'s No.	Name of Engine.	Name of Engineer.	Wheel
1	COMET	R. Stephen	f
2	PHENIX	R. Stephen	
3	SAMSON	R. Stephen	
4	GOLIATH	R. Stephen	
5	HERCULES ..	R. Stephen	
6	ATLAS	R. Stephen	
7	LIVERPOOL ..	Edward	
8	VULCAN	Tayleur	
9	AJAX	Haigh Fc	
10	HECTOR	Haigh Fc	

axle, causing them to engage with either the forward or backward "stud" at pleasure.

The starting or reversing of the engine was accomplished by the engine-driver opening the regulator, and placing his foot upon the "treadle" in order to disengage the eccentrics from the "stud;" another handle enabled him to lift up the small ends of the eccentric-rods, after which he took hold of the two valve levers on the foot-plate, and by moving them backwards and forwards admitted steam to the cylinders by the hand-gear; when the engine was fairly started, he by means of the treadle caused the eccentrics to engage with the opposite "stud" and it continued to actuate the valves; it therefore follows that the handles of the reversing gear upon the foot-plate were constantly moving backwards and forwards during the time the engine was in motion.

The rod of the tender brake passed in a tube through the water tank, and the handle could only be reached by climbing upon the coke.

The chimney of the "Comet," when constructed, was 13 feet in height from the rail level; but it was knocked down in the Glenfield Tunnel on the opening day, and was afterwards reduced to 12 feet 6 inches.

The weight of the "Comet" in working order was 9 tons 9 cwts. 2 qrs., and of the tender fully loaded $3\frac{1}{2}$ tons. In December, 1836, it was sold and sent to be a ballast engine at the making of the London and Birmingham Railway.

Full particulars relating to this engine are given in the annexed copy (see folding plate) of the Company's locomotive list, drawn up by Mr. John Nicholson, the engine superintendent, in 1839.

The second engine built by Messrs. Stephenson for the Leicester and Swannington Railway was the

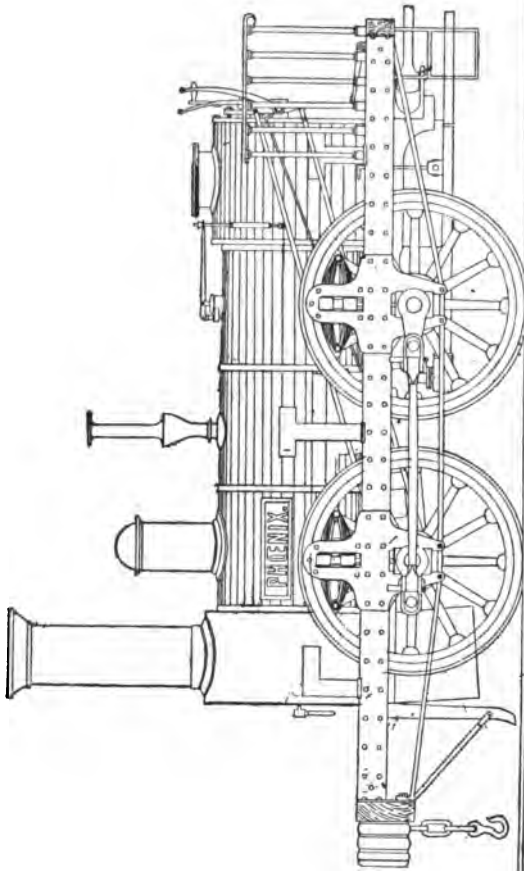

Fig. 25.—“Phoenix,” No. 2, Leicester and Swannington Railway, August, 1832.

“Phoenix,” delivered “in steam” at Leicester, 28th August, 1832.

The springs of “Phoenix” (Fig. 25) were of the Grasshopper pattern; but the experiments made by

1

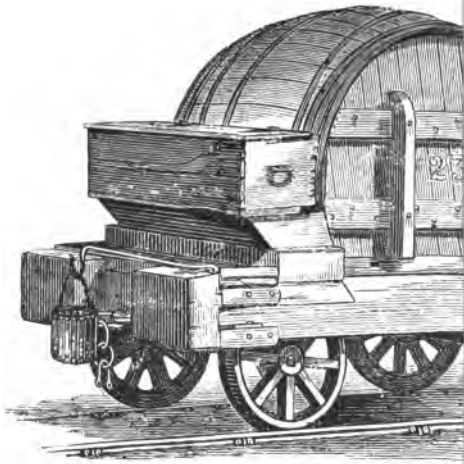

Fig.

Mr. Cabry, the Company's engine superintendent, showed that they possessed no advantages, and that pattern of spring was therefore not repeated.

In December, 1836, the "Phoenix" was sold and sent to the Birmingham and Gloucester Railway Company, to be used as a ballast engine at the making of that line.

Towards the close of the year 1831, and during the year 1832, several new engines were placed upon the Stockton and Darlington Railway numbered from 12 to 23 (see list, pp. 21, 22). They had boilers with either return-flues or return-tubes, and two tenders. No. 23 is illustrated (Fig. 26).

The "Wilberforce," No. 23, was designed by T. Hackworth, and constructed by Messrs. R. & W. Hawthorn for the Stockton and Darlington Railway, 1832. The chimney and fire-door were both at one end of the engine, the cylinders were placed vertically, and the connecting-rods attached to an intermediate crank. The cylinders were $14\frac{3}{4}$ inches diameter, the stroke 16 inches in length, and the wheels 4 feet diameter. With coal trains the engine burnt about 68lb. of coal per mile. The fire-basket, which did duty for a head or tail lamp, is shown at the back of the water-tender.

Mr. Edward Bury, of Liverpool, who afterwards became head of the well-known firm of Bury, Curtis, and Kennedy, and ultimately the locomotive superintendent of the London and Birmingham Railway, was an engineer who took an important part in the early history of the locomotive, and he introduced several features which deserve to be placed on record. Mr. Bury became a locomotive builder shortly after the opening of the Liverpool and Manchester Railway.

He approved of the "bar-framing," of a circular fire-box, with the top of the fire-box casing formed in a large dome, and arranged the tubes in curved rows instead of straight; he also built up the wheels, the spokes being attached by screw bolts to the rim and the boss. Mr. Bury was the leading and most powerful advocate of the four-wheeled engine. He contended that it was less costly than that on six wheels, that it could be got into less space, was lighter and safer, as in his opinion it adapted itself better to the rails. The question of four *versus* six wheels engaged constant attention between the years 1832 and 1854; the competition was extremely severe, but ultimately Mr. Bury's "four-wheeled theory" was proved to be erroneous.

His first four-wheeled, inside cylinder engine, was commenced in January, 1831. It was named "Liverpool" (see p. 200); after a trial trip in England it went to America to the Petersburg Railroad, where, afterwards, it was known or renamed "Spitfire."

The Liverpool and Manchester Railway Company's list (see p. 37) shows that in 1832 Mr. Bury built one of his engines, the "Liver," No. 26, for that line, having cylinders 11 by 16 and 5 feet driving-wheels.

Messrs. Galloway, Bowman & Glasgow, in 1832, constructed an engine for the Liverpool and Manchester Railway (Fig. 27); it ran upon four wheels of 5 feet diameter, coupled, and as the makers disapproved of the usual "cranked-axle," they placed the cylinders vertically in front of the smoke-box.

The engine was not successful, and after running off the rails upon several occasions, was rebuilt with inside cylinders and a crankod-axle.

Fig. 28 illustrates an old locomotive engine, named "Iron-sides," built for the Philadelphia, Germantown, and Norristown Railway Company. It is of interest, being the first railroad locomotive constructed by Mr. Baldwin, the founder of the now famous "Baldwin

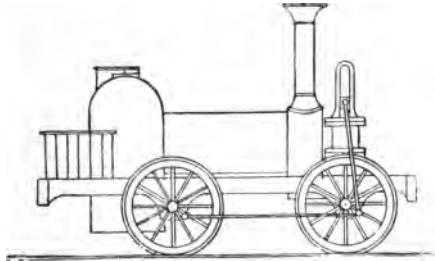

Fig. 27.—"Caledonian," No. 28, Liverpool and Manchester Railway, 1832.

Locomotive Works," Philadelphia, and it was completed and ran a trial trip on November 23rd, 1832.

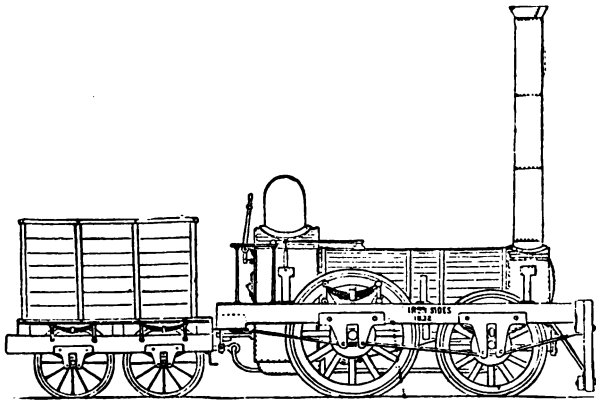

Fig. 28.—"Iron-sides," an American Engine, November, 1832.

It will be seen that the "Iron-sides" was a four-wheeled engine modelled essentially on the English practice

of that time, and was very similar to the "Planet" and "Mercury" class introduced upon the Liverpool and Manchester Railway by George Stephenson, in

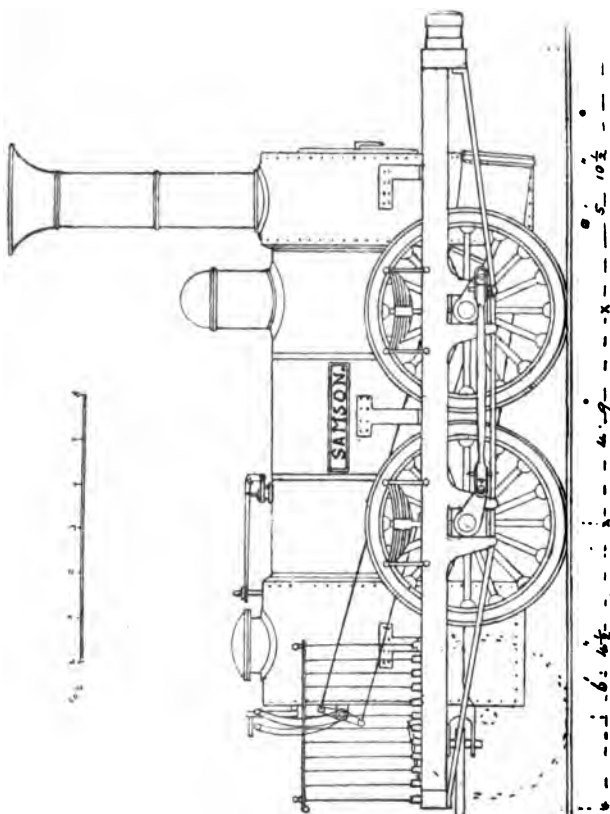

Fig. 29.—"Samson," No. 3, Leicester and Swannington Railway, 1st January, 1833.

1830; the cylinders being $9\frac{1}{2}$ inches diameter, 18 inches stroke, and the driving-wheels 4 feet 6 inches diameter.

In August, 1832, Messrs. R. Stephenson & Co. commenced the construction of two locomotives for the Leicester and Swannington Railway. These had cylinders 14 inches diameter, 18 inches stroke, and four coupled wheels of 4 feet 6 inches diameter, the wheel-base being 4 feet 9 inches, and the total length of the frame 17 feet. The first of these engines was named "Samson" (Fig. 29), and commenced work at Leicester, on 1st January, 1833; the other, "Goliath," followed 20th March, 1833.

One of the first events in the history of the "Samson" was that it ran into a horse and cart crossing the line at Thornton, the cart being loaded with butter and eggs for the Leicester market. The engine-driver had but the usual "horn," and could not attract attention. Mr. Ashlen Bagster, the manager of the railway, went the same day to Alton Grange to report the circumstance to Mr. George Stephenson, who was one of the directors and the largest shareholder. After various ideas had been considered, Mr. Bagster remarked: "Is it not possible to have a whistle fitted on the engine which steam can blow?" George Stephenson replied, "A very good thought, go and have one made," and such an appliance was at once constructed by a local musical instrument maker. It was put on in ten days, and tried in the presence of the board of directors, who ordered other trumpets to be made for the other engines which the company possessed. The following illustration (Fig. 30) is a copy of the official drawing.

The accident at Thornton was therefore the origin of the steam whistle, and the bell whistle, as we now have it, is an improvement upon the trumpet. When new

the "Samson" and "Goliath" had iron fire-boxes and copper tubes. These tubes were found to wear out very quickly, and the author has read correspondence addressed by Mr. Cabry to the makers, showing that within four months copper tubes were bursting and delaying the trains, and during the

[COPY.]

"LEICESTER AND SWANNINGTON RAILWAY.

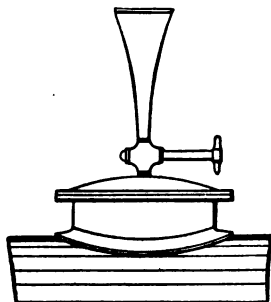

Height, 1 ft. 6 in. ; diam. of top, 6 in.

Engine Superintendent's Office, Leicester.

(Signed) HENRY CABRY.

May, 1833."

Fig. 30.—The Steam Trumpet.

summer of 1833 brass tubes were substituted in these engines.

During the year 1833 the portion of the Leicester and Swannington Railway extending from the top of the Swannington to the top of the Bagworth incline was opened by the "Samson" (Fig. 29), driven upon the occasion by Mr. Robert Stephenson.

It was very soon found in practice that the "Samson" and its fellow engine "Goliath," having a long frame

and short wheel base, caused considerable oscillation and threatened serious damage to the permanent way. It was therefore decided by the directors, acting upon the advice of one of their number, Mr. George Stephenson, to have a small pair of trailing wheels added behind the fire-box in the position shown on the diagram. The necessary pairs of wheels and axle-boxes were sent from Newcastle to Leicester, where they were attached by the company's fitters, under the direction of Mr. Cabry, engine superintendent.

Thus the Swannington Company's "Samson" and "Goliath," in the early part of the year 1833, became the first inside cylinder goods engines upon six wheels. The flanges were also taken off the middle or driving-wheels. The change from four to six wheels increased the wheel base to 9 feet 1 inch, and proved so satisfactory that Mr. George Stephenson, after riding upon the "Samson," decided never to build another four-wheeled engine, and he at once took steps to add similar pairs of wheels to the goods engines he had constructed for the Liverpool and Manchester Railway.

The South Carolina Railroad Company ordered an engine from Messrs. Stephenson, and it was placed on that line in 1833, named "Edgefield" and No. 54 in the books and records of the makers. It had cylinders 10 inches by 16 inches and four coupled wheels of 4 feet 6 inches diameter, its weight in working order being only 6 tons 4 cwts. Some writers have expressed surprise that such a small engine should have been built *after* others of larger dimensions. It is therefore necessary to record the fact that the rails were not suitable to carry an engine of either greater weight or longer wheel-base. Another engine built

by the same makers in 1833, for the Hudson and Mohawk Railroad Company, was named "Brother Jonathan;" it was also limited in size and weight.

Messrs. R. Stephenson & Co., in 1833, constructed an engine for the Saratoga and Schenectady Railroad of America; it had a leading bogie, and a single pair of driving-wheels placed behind the fire-box. The "bogie" was found to work very satisfactorily upon sharp curves, and has always been in use upon American passenger engines.

Mr. Roberts—of the firm of Messrs. Sharp, Roberts & Co., now Sharp, Stewart & Co.—in the year 1833 designed and constructed an engine for the Liverpool and Manchester Railway (Fig. 31).

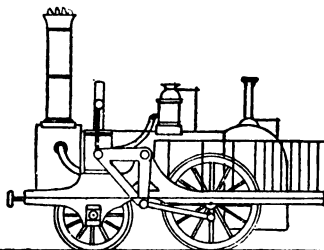

Fig. 31.—"Experiment," No. 32, Liverpool and Manchester Railway, 1833.

The cylinders were placed vertically over the leading wheels, the motion of the cross-heads being communicated to the crank-pins upon the driving-wheels by means of connecting-rods and bell-cranks. The leading wheels had outside, and the driving-wheels inside bearings; the cylinders were 11 inches diameter, the stroke 16 inches, and the driving-wheels 5 feet diameter.

This engine had no eccentrics to actuate the valves, a short lever on the bell-crank giving the throw by a

long rod to rocking gear on the foot-plate. The valves were tubular, without lap or lead. The pistons had not the usual elastic packing rings, but were made nearly frictionless by exactly fitting the vertical cylinders, and having a white metal surface.

This engine was very unsteady when running, and

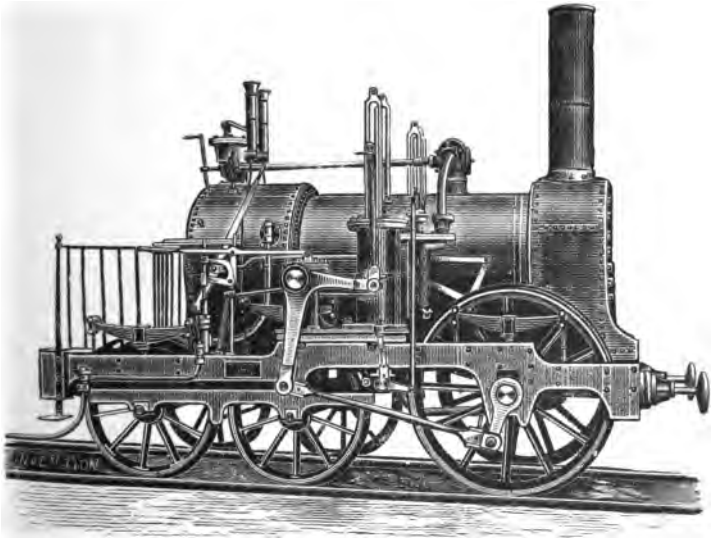

Fig. 32.—“The Earl of Airlie,” No. 1, Dundee and Newtyle Railway, 1833.

after running off the line it was rebuilt with the position of the cylinder and bell-crank altered, and another pair of wheels was afterwards added, but it proved a complete failure.

Fig. 32 illustrates an interesting link in locomotive history, showing as it does one of the first engines

having a "bogie" ever used on a railway in this country.

This engine was built by Messrs. Carmichael & Co., of Dundee, and commenced work upon the Dundee and Newtyle Railway, September, 1833, and during the same month "The Lord Wharnccliffe," No 2, was completed; followed by "The Trotter," No. 3, in March, 1834.

These three engines were in every respect similar, and had a single pair of driving-wheels 4 feet 6 inches in diameter, placed in front, and a four-wheeled bogie,

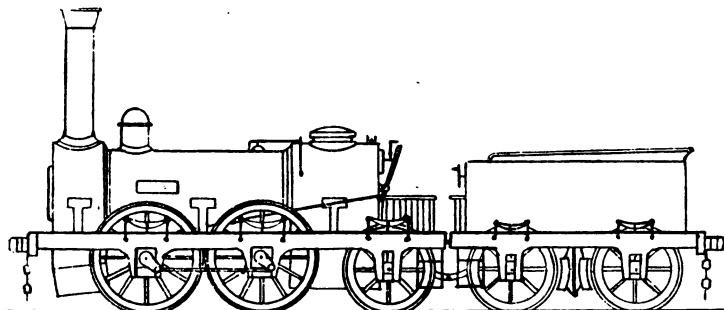

Fig. 33.—"Hercules," Leicester and Swannington, Dec. 1833.

the cylinders being vertical, 11 inches in diameter, and the stroke 18 inches. Weight of engine, in working order, without tender, 9 tons 10 cwts.; cost of engine, without tender, £700. Gauge of railway, 4 feet 6 inches.

Messrs. R. Stephenson & Co. delivered the "Hercules" to the Leicester and Swannington Railway Company, 17th December, 1833, being No. 36 in the books of the makers, and No. 5 in those of the Company (Fig. 33); it had copper fire-box and brass tubes.

The cylinders were 14 inches by 18 inches, the

working pressure of steam being 55lbs. per square inch, which was afterwards increased to 60lbs. When built, this engine had a flange upon the driving-wheels; this was, however, removed after it had been at work about three months.

Experience having proved that six-wheeled goods engines were superior to four-wheeled, Messrs.

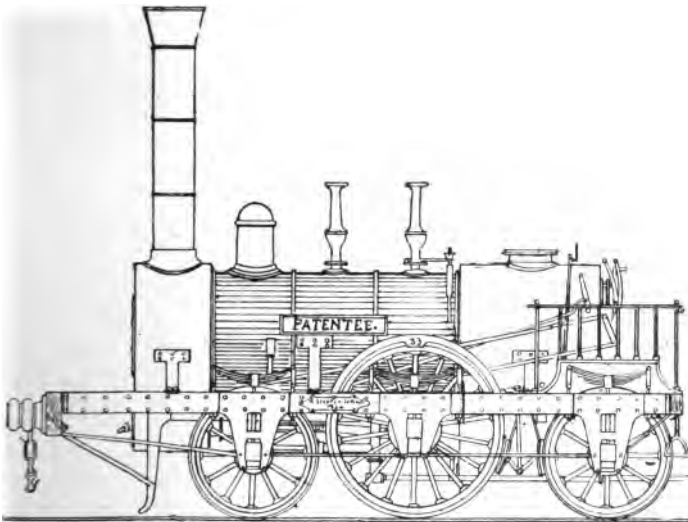

Fig. 34.—"Patentee," No. 33, Liverpool and Manchester Railway, January, 1834.

Stephenson determined to apply the same principle to passenger engines, and constructed the "Patentee" for the Liverpool and Manchester Railway, upon the model of the "Mercury" (Fig. 21), but with an additional small pair of trailing wheels under the foot-plate. This engine (Fig. 34) was named "Patentee,"

on account of its being the first constructed by Stephenson under his patent of 1833, which provided that six-wheeled engines should have no flanges upon the middle pair of wheels, in order that they could easily pass round curves.

The cylinders were 12 inches by 18 inches, and the driving-wheels 5 feet diameter.

Special attention should be directed to this engine, which became a standard pattern, and was very extensively copied in this country and all parts of the world, and many of the modern passenger engines are "developments" of the "Patentee."

The large increase in the coal traffic upon the Leicester and Swannington Railway necessitated the use of more powerful engines to convey the trains over the rising gradients between the top of the Swannington incline and the top of the Bagworth incline. To overcome the difficulty, Mr. Stephenson decided to construct a new engine, having six coupled wheels; it was delivered at Leicester 8th February, 1834 (Fig. 35).

The "Atlas" had cylinders 16 inches by 20 inches, and weighed 17 tons, in working order, without the tender; it was, therefore, when built, the largest, heaviest, and most powerful locomotive running; its working was therefore watched with considerable interest, as shown by the reports which had to be sent weekly to the directors, and to the makers, for several months, and the copies we have seen in the railway company's books show that the "Atlas" was "highly satisfactory." It was stationed at the Long Lane, now Coalville, and worked for fully 25 years, becoming the property of the Midland Railway Company when the Swannington line was purchased. This engine was

afterwards let on hire to colliery owners, and was ultimately sold to a contractor, being finally broken up after working for more than 40 years.

It was the first goods engine ever built combining the six coupled wheels and inside cylinders—a pattern since very generally employed. The boiler was flush-topped, clothed with polished oak strips, bound round with brass hoops; a steam-trumpet was provided. The

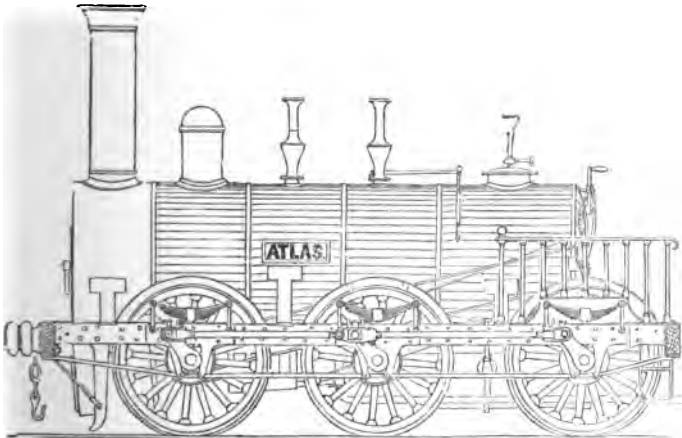

Fig. 35.—“Atlas,” Leicester and Swannington Railway, Feb. 1834.

wheels were 4 feet 6 inches diameter, the driving-wheels without flanges. A long and most complete series of experiments was carried out by Mr. Henry Cabry, the company’s engine superintendent, to ascertain exactly its performance, the result being that several other engines of similar design were built for other railways.

The Leicester and Swannington list (see page 45) shows that the first six engines for that line were built by Stephenson & Co. However, in 1833 some of the

directors desired to give a trial to Bury, Tayleur and the Haigh Foundry Company, but Mr. Stephenson being a director, they appear to have felt anxious to know the opinion of their colleague. It was, therefore, decided to write a private note on the subject, to which George Stephenson wrote the well-known reply:—
“Very well; I have no objection, but put them to this fair test; hang one of Bury’s engines on to one of mine, back to back; then let them go at it, and whichever walks away with the other, that’s the engine.”

The order was given to Mr. Bury in 1833, who personally assured the directors that “whatever Stephenson’s engine could do his could do,” and an engine named the “Liverpool” was placed upon the line during the year 1834 (Fig. 36).

The “Liverpool” (Fig. 36) ran upon four wheels, 4 feet 6 inches diameter, the cylinders being 12 inches diameter, and the stroke 20 inches. Weight of engine in working order 10 tons, weight of tender loaded 4 tons 10 cwt.

A peculiar feature in this engine was that the two eccentrics were placed upon the leading axle, and the eccentric rods passed in two spaces or boxes through the smoke-box to the valve-levers placed behind the buffer beam; it therefore followed that the admission of steam to the cylinders for working the driving-wheels was dependent upon the movement of the leading wheels and coupling-rods; consequently any failure of crank-pins or coupling-rods rendered the engine useless, and the books of the company recorded two or three such failures.

The engine was reversed by means of four handles, two to work the valves by hand, one gab-handle to

throw the small ends of the eccentric-rods into or out of gear, and one to move the two eccentrics.

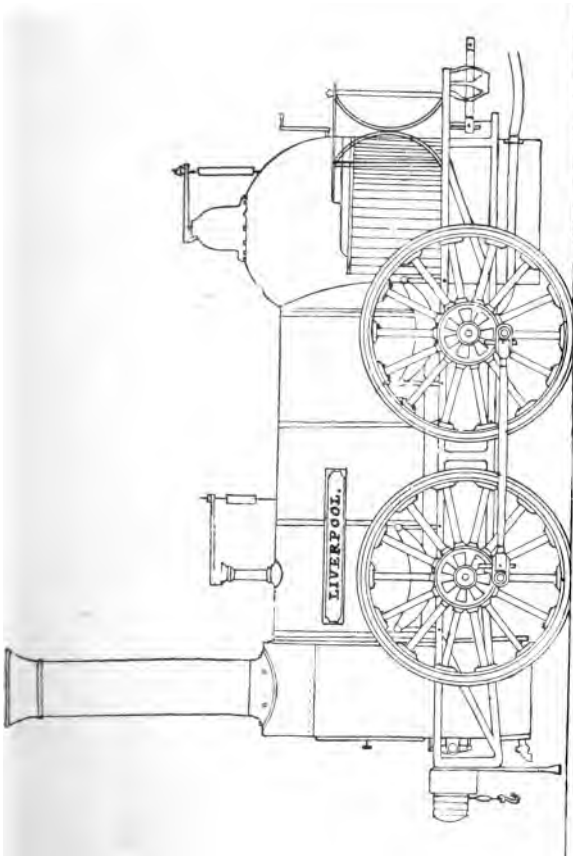

Fig. 36.—"Liverpool," No. 7, Leicester and Swannington Railway, 1834.

A series of practical trials were made with a train of waggons upon the Swannington Railway in the

presence of the directors, when Mr. Bury was ultimately obliged to admit that his engine (Fig. 36) was not equal to taking the trains conveyed by Stephenson's "Atlas" (Fig. 35).

In 1834, Messrs. Sharp, Roberts & Co. supplied three engines exactly similar to the "Experiment" (see Fig. 31), for the opening of the Dublin and Kingstown Railway, named "Hibernia," "Manchester," and "Britannia."

None of these engines were found satisfactory, and the firm abandoned the "bell-crank" design.

Mr. George Forrester opened the Vauxhall foundry at Liverpool in 1834, the first locomotive constructed by the firm being the "Swiftsure" (Fig. 37).

This engine was the first ever constructed combining *outside* horizontal cylinders and six wheels. The connecting-rod, it will be observed, worked upon an outside crank. The "Swiftsure" also was the first locomotive ever built with *four* eccentrics.

This valve gear was Forrester's patent, in which each of the four eccentrics was furnished with a fork or "gab-end," and placed vertically, as shown (Fig. 37.)

The chief dimensions of the "Swiftsure" were cylinders 11 by 18, driving-wheels 5 feet diameter, total length of frame 17 feet.

In consequence of the extreme distance apart of the cylinders, 7 feet 1 inch, and the unbalanced driving-wheels, this and other similar engines oscillated to a very serious and dangerous extent at even moderate speed. They were generally known as "Boxers," and proved a practical failure, as they could not be allowed to exert their full power or speed, as they either left the line or burst the rails.

During the year 1834 Messrs. Forrester built three four-wheeled engines for the Dublin and Kingstown

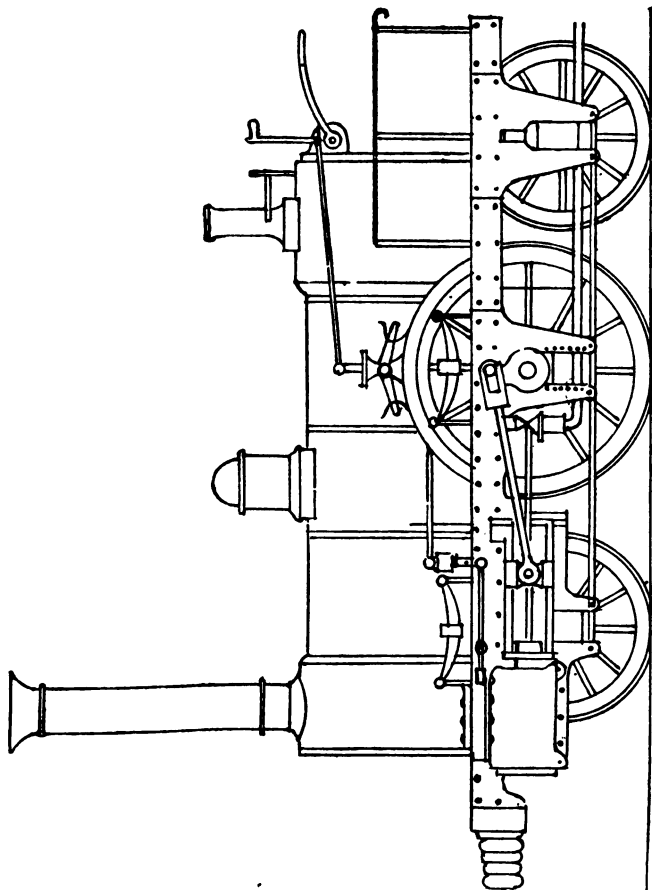

Fig. 37.—“Swiftsure,” No. 36, Liverpool and Manchester Railway, 1834.

Railway named “Dublin,” “Kingstown,” and “Vauxhall;” like the “Swiftsure,” they were very unsteady.

Messrs. R. & W. Hawthorn & Co., of Newcastle, designed and constructed in 1835 an engine for the Newcastle and Carlisle Railway (Fig. 38).

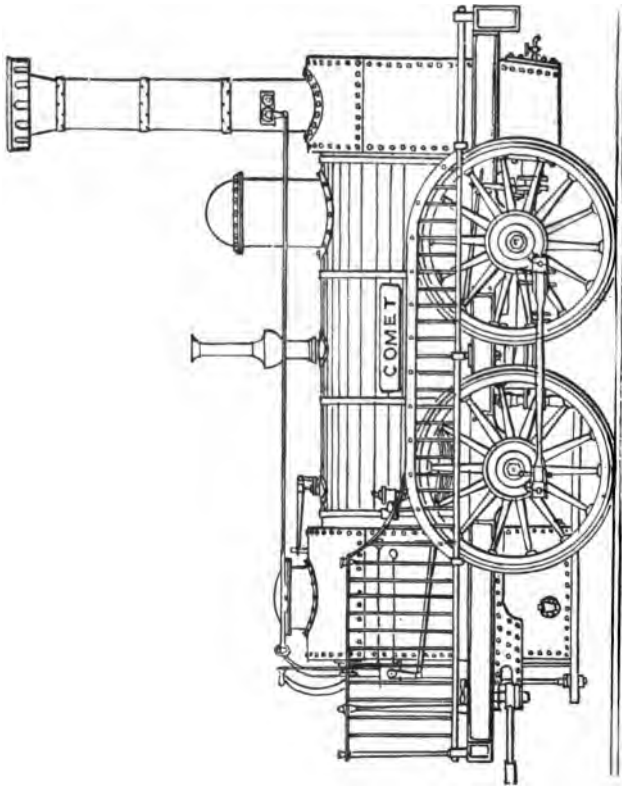

Fig. 38.—“Comet,” No 1, Newcastle and Carlisle Railway, 1835.

The “Comet” (Fig. 38) conveyed one of the trains of passengers at the opening of the first section of the Newcastle and Carlisle Railway, March 9, 1835. It had four coupled wheels 4 feet diameter, the cylinders

were 12 inches diameter, and the stroke 16 inches; it will be seen that they were placed low down under the smoke-box, the piston-rod working under the leading axle. The valves of the "Comet" were actuated by Hawthorn's gear.

Heating surface of fire-box	35 square feet.
Heating surface of tubes	237 square feet.
Total	272

Pressure of steam 60 lbs. per square inch. The tender ran upon four wheels and carried 680 gallons of water.

The "Comet" and several other engines of a similar design worked with great efficiency for many years upon the Newcastle and Carlisle Railway.

Another powerful locomotive being required for the Leicester and Swannington Railway, an order was given to Messrs. Tayleur & Co., of the Vulcan Foundry, near Warrington. The engine (Fig. 39) was delivered "in steam," at the West Bridge Station, Leicester, on the 2nd April, 1835. It had cylinders 16 by 20, and six coupled wheels of 4 feet 6 inches diameter, and was a very similar type to the "Atlas" (Fig. 35). The valve gear was of the loose eccentric type, described pages 44 and 45.

During the early part of the year 1836, Messrs. Tayleur & Co. completed the "Star" for the Liverpool and Manchester Railway, being the first of an order of ten "short-stroked" passenger engines. The cylinders were 14 inches diameter, only 12 inches stroke, the driving-wheels being 5 feet diameter. It was found in practice that the "short stroke" was not an advantage.

Messrs. R. Stephenson & Co. in 1836 constructed

several passenger engines upon a similar design to the "Patentee" (Fig. 34), but of larger size, one of which is shown in section (Fig. 40).

It will be observed (Fig. 40) that the steam dome was placed upon the fire-box casing, also that the engine had four fixed eccentrics, and forked-ends to the eccentric-rods ; the two " forward " or two " back-

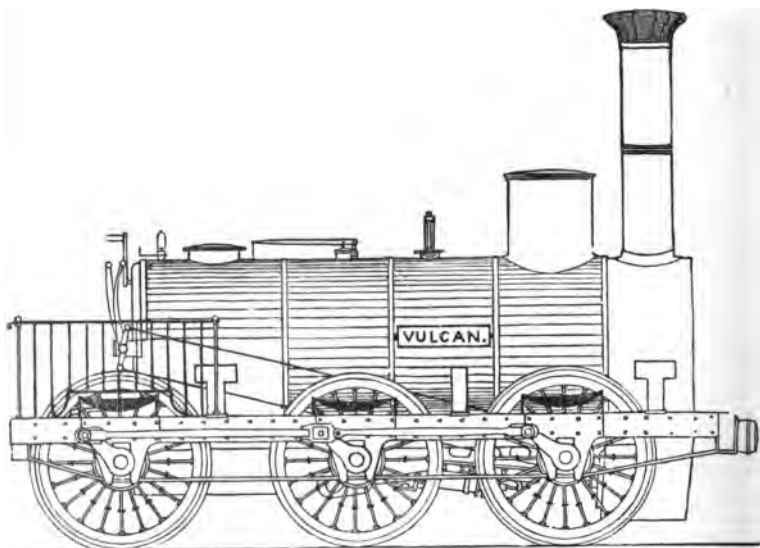

Fig. 39.—"Vulcan," No. 8, Leicester and Swannington Railway, 1835.

ward " forks were placed in or out of gear by one reversing lever ; the valves were still retained above the cylinders.

The Newcastle and Carlisle Railway Company had the greatest objection to heavy engines, and to the concentration of weight ; Messrs. R. Stephenson & Co.

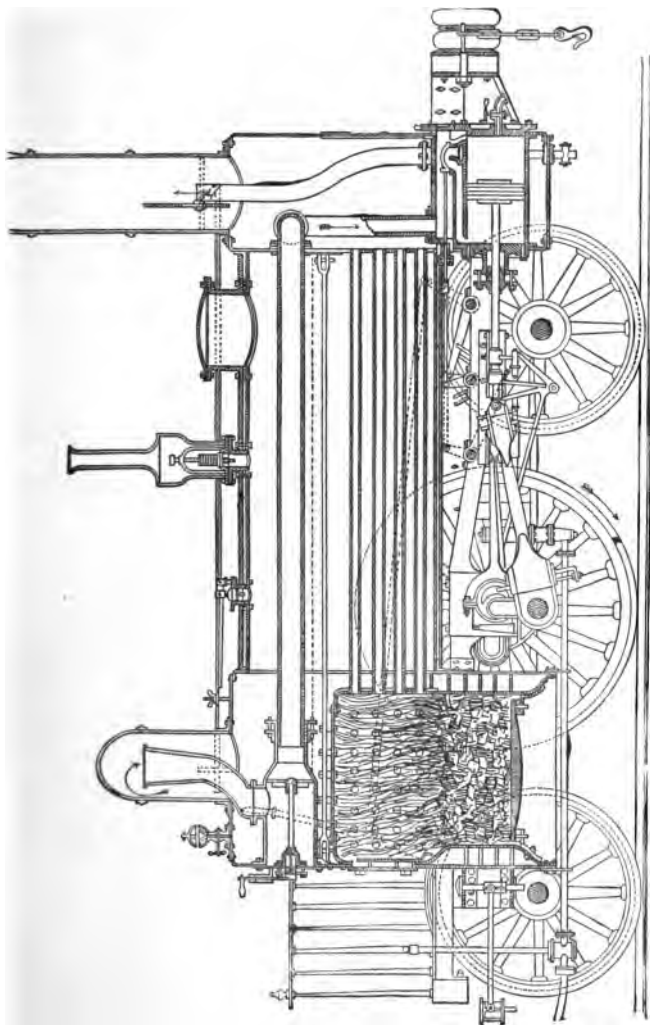

Fig. 40.—R. Stephenson's Standard Passenger Engine, 1836.

therefore built the "Atlas" (Fig. 41) for that line, in 1836, having cylinders 14 by 18, and six coupled wheels of 4 feet 6 inches diameter, the weight, however, in working order being only 11 tons $6\frac{1}{2}$ cwts.

The "Ajax" (Fig. 42) was built by the Haigh Foundry Company, Wigan, and placed upon the Leicester and Swannington Railway, October, 1837; it had cylinders 14 by 18, and four coupled wheels 4 feet 6 inches diameter. The builders decided to employ tubes of $2\frac{1}{4}$ inches diameter instead of $1\frac{5}{8}$ inches,

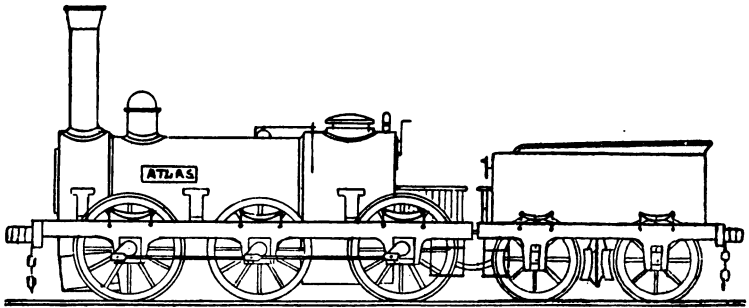

Fig. 41.—"Atlas," Newcastle and Carlisle Railway, 1836.

which was the usual practice at that date. Length of boiler between the tube plates 8 feet 8 inches. The valves were actuated by the "Haigh Foundry" gear, having four eccentrics and forked-ends to the eccentric-rods, the weight-bar shaft being placed *above* the eccentric-rod.

Messrs. Hawthorn constructed the "Swift," No. 26, for the Stockton and Darlington Railway; it was a four-wheeled engine with vertical cylinders, the connecting-rods working down to an intermediate shaft, coupled at each side to the wheel crank-pins by coup-

ling-rods. No. 27, for the same railway, was named the "Arrow," built by T. Hackworth in 1837, the cylinders were no less than 22 inches diameter, and the stroke only 9 inches. Neither of these engines was successful, and the designs were abandoned.

The first portion of the London and Birmingham Railway was opened July 20th, 1837, and the com-

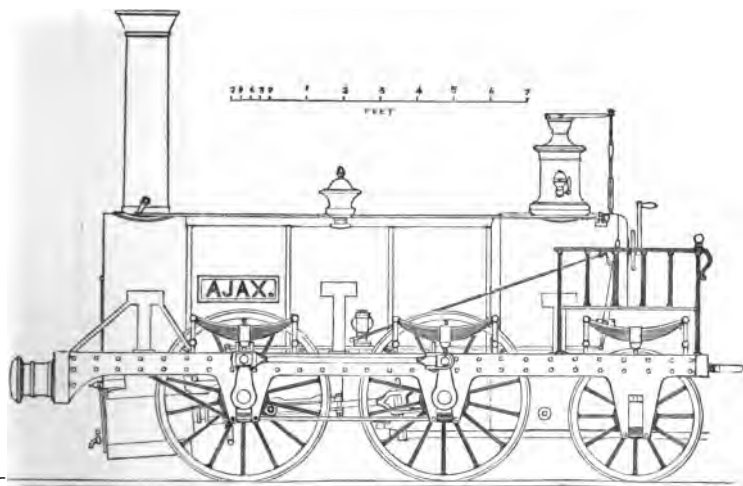

Fig. 42.—"Ajax," No. 9, Leicester and Swannington Railway, 1837.

pleted line September 17th, 1838. Mr. Edward Bury, of Liverpool, on becoming locomotive superintendent at Wolverton, unfortunately induced the directors to accept his views in favour of four-wheeled engines. The whole of that company's locomotive stock (with one exception) therefore had only four wheels. The passenger engines had single driving-wheels, 5 feet 6 inches diameter, and the "goods" had four coupled wheels, some 4 feet 6 inches and others 5 feet dia-

meter, the goods engines being of very similar construction to the "Liverpool," illustrated (Fig. 36).

Soon after Messrs. Stephenson adopted the engine

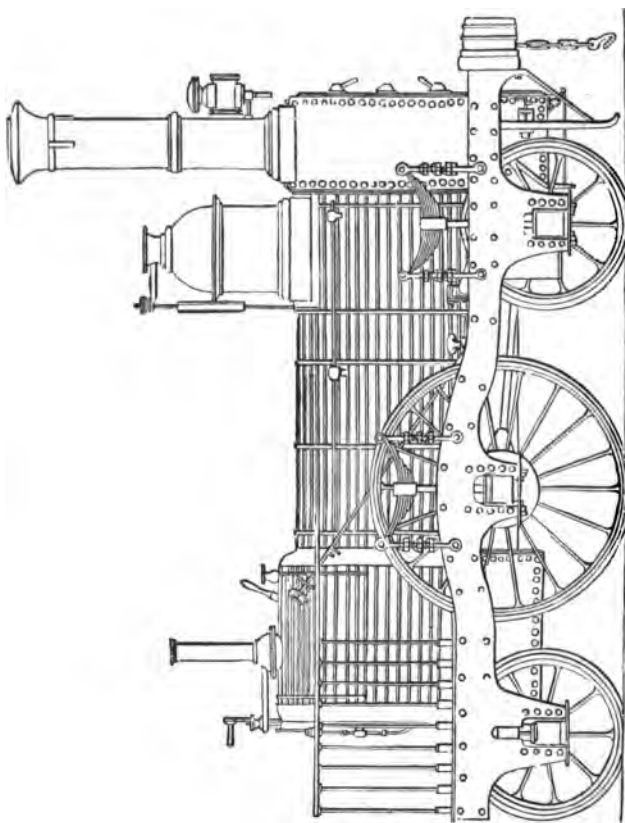

Fig. 43.—Sharp's Standard Passenger Engine, 1837.

(Fig. 40) as their standard passenger locomotive. Messrs. Sharp, Roberts & Co., of the Atlas Works, Manchester, adopted the design shown (Fig. 43).

During the year 1837 Sharp, Roberts & Co. placed several of their standard engines upon the Grand Junction Railway, named—

"Centaur" .. No. 12	"Wizard" .. No. 21
"Caliban" .. " 17	"Basilisk" .. " 22
"Cerberus" .. " 18	"Vizier" .. " 23
"Doctor Dalton" .. " 19	"Sirocco" .. " 24
"Eagle" .. " 20	"Harpy" .. " 25

All these had cylinders $12\frac{1}{2} \times 18$ and driving wheels 5 feet diameter, their weight when empty being 12 tons 5 cwts.

The design illustrated (Fig. 43) continued to be Sharp's standard pattern for nearly twenty years, and many hundreds of engines were built—their size and power of course increasing from $12\frac{1}{2}$ inch cylinders to 17 inches, and the driving wheels from 5 feet to 6 feet 6 inches; and several engines of this old design were at work till a very few years ago.

So far it has only been necessary to refer to engines running upon the ordinary 4 feet $8\frac{1}{2}$ inch gauge, that being the only width employed in this country, with the exception of a gauge of 4 feet 6 inches on a few Scotch lines. However, Mr. Brunel, when laying out the Great Western Railway, unfortunately decided to adopt a broad gauge of 7 feet, and Parliament unwisely permitted the introduction of various gauges.

The broad gauge, however, although practically unnecessary and financially a failure, did more than anything else to improve and develop the locomotive engine, by creating the rivalry known as the "battle of the gauges," which lasted for fully fifteen years.

CHAPTER III.

THE COMMENCEMENT OF THE BATTLE OF THE GAUGES.

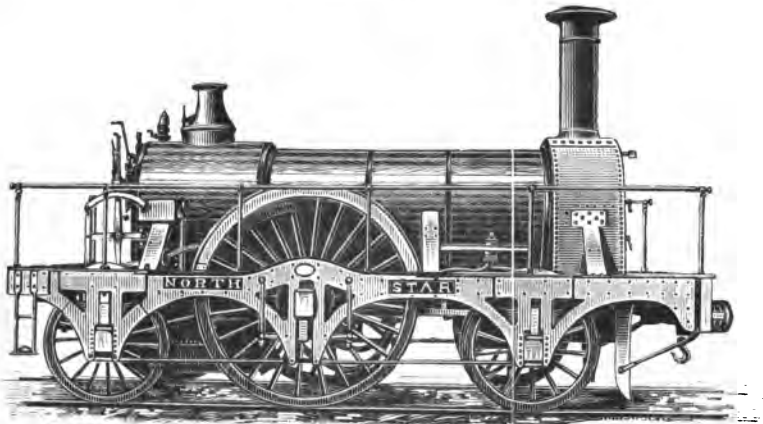
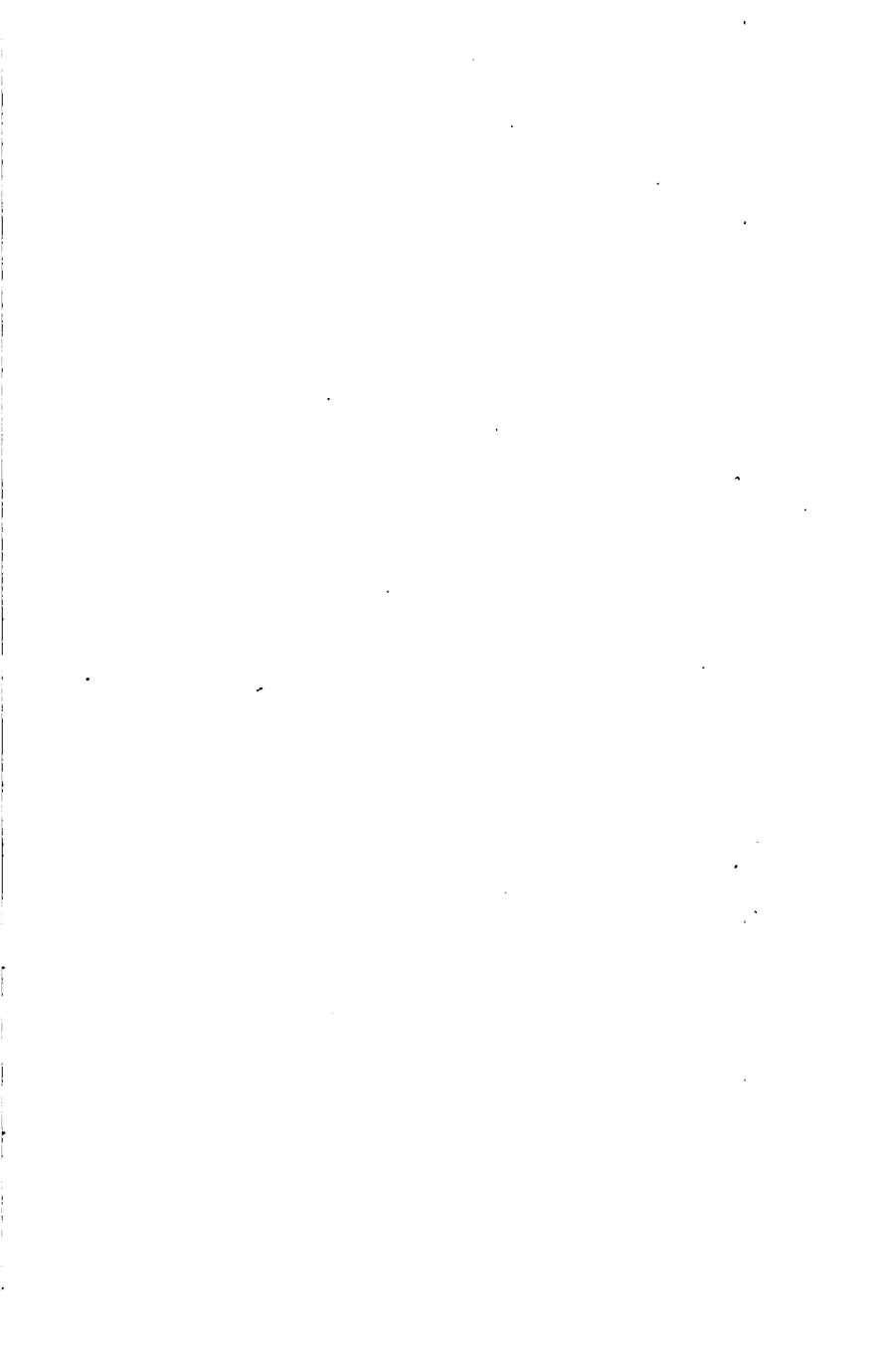

Fig. 44.—“North Star,” No. 1, Great Western Railway, 1837.

EARLY in the year 1837 Mr. Brunel, the engineer of the Great Western Railway, then in course of construction, held consultations with the leading locomotive builders of the day, and explained to them the work which the engines would be required to perform. Each maker then prepared his own designs, and



COPY.] THE GREAT WE

Date when Built.	Name of Engine.	Number in Books of Company.	
1837	NORTH STAR . .	1	E
	VULCAN . . .	2	C
1837	ÆOLUS . . .	3	C
1837	BACCHUS . . .	4	C
1838	PREMIER . . .	5	M
1838	ARIEL . . .	6	M
1838	LION	7	S
1838	ATLAS . . .	8	S
1838	EAGLE . . .	9	S
1838	APOLLO . . .	10	C
1838	NEPTUNE . .	11	C
1838	VENUS . . .	12	C
1838	SNAKE . . .	13	M
1838	VIPER . . .	14	M
1838	AJAX	15	M
1838	THUNDERER . .	16	Boiler e.
1838	PLANET . . .	17	M
1838	HURRICANE . .	18	ame.
1838	MERCURY . .	19	M
1838	MORNING STAR .	20	M

submitted the same to the Locomotive Committee, with the result that the following orders were given:—

To R. Stephenson & Co.	1 engine.
„ Charles Tayleur & Co.	3 engines.
„ Mather, Dixon & Co.	2 „
„ Sharp, Roberts & Co.	3 „

Further orders were then given—

To Tayleur & Co.	for 3 engines.
„ Haigh Foundry Company	„ 2 „
„ Mather, Dixon & Co.	„ 3 „
„ Messrs. Hawthorn (Harrison's patent)	„ 2 „
„ R. Stephenson & Co.	„ 1 engine.

The directors of the Great Western Railway appointed Mr. (afterwards Sir Daniel) Gooch as Locomotive Superintendent, and for years past it has been supposed that *he* designed the first engines. However, the official drawings, details, and diagrams sent to the Chicago Exhibition in 1893 conclusively prove that the first engines designed by Mr. Gooch were not delivered on the line till early in 1840. An original tabulated statement drawn up in January, 1839, showing the names of the Company's engines to the close of the year 1838, was also exhibited; and the details are given on the folding plate annexed.

The first engine delivered on the line was the "North Star" (Fig. 44), constructed by R. Stephenson & Co., 1837. It was No. 1 in the books of the railway company, and No. 150 in those of the makers. As stated by Mr. Stephenson and Mr. Brunel in their evidence before the Gauge Commission, this engine was constructed for a railroad in America, upon a 6-foot gauge. It was not, however, delivered, but was altered for the Great Western Railway, upon which line it was

placed in December, 1837, and ran its first trip on 1st January, 1838; it commenced daily work when the first portion of the Great Western Railway was opened to Maidenhead, on June 4th, 1838, continued at work for thirty-two years, and ran a distance of 429,000 miles, and is still preserved at Swindon.

When the orders for the engines were given to the makers, Mr. Brunel specially stipulated that a complete set of drawings should be furnished to the company, with each order, free of charge. The various makers also retained duplicate copies for their own information, and it is a most important circumstance that official drawings of all the engines exist at the present day. One complete set of the drawings was exhibited at Chicago in 1893, and another set has been photographed and traced, and these copies are preserved at the South Kensington Museum, and at the City Free Library at Liverpool. No company has a more complete record of its early engines than the Great Western (see also under Chapter IX., page 217).

The Grand Junction Railway, opened 4th July, 1837, formed a very important link, connecting the London and Birmingham Railway, at Birmingham, with the Liverpool and Manchester Railway at Newton Junction. Mr. Locke, the company's engineer, decided that all the locomotives should run on six wheels. The passenger engines were designed and ordered to have driving wheels of 5 feet 6 inches diameter, but in view of the larger wheels introduced by Messrs. Brunel and Gooch, and the taunts of the advocates of the broad gauge that the narrow gauge could not have large wheels, it was decided that a few of those engines (the construction of which had not proceeded too far) should

be provided with 6-foot wheels, one of which is illustrated (Fig. 45).

This locomotive was constructed by the Haigh Foundry Company, and delivered September 20th,

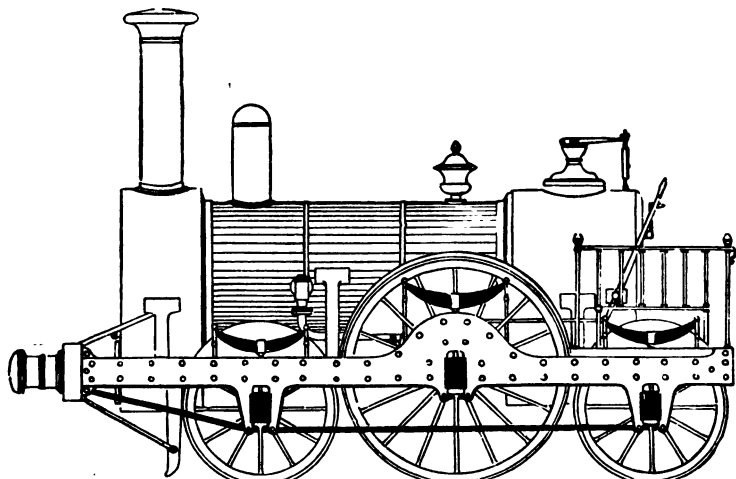

Fig. 45.—Grand Junction Railway, 1838.

1838, and is interesting, showing as it does a good specimen of narrow-gauge engine of that period.

Diameter of driving wheels	6 feet 0 inch.
Diameter of carrying wheels	4 " 0 "
Diameter of cylinders (13 $\frac{3}{4}$)	1 " 1 $\frac{3}{4}$ "
Length of stroke (18)	1 " 6 "
Number of tubes, 102	
Diameter of tubes inside	0 " 2 "
Heating surface of tubes	480 square feet.
Heating surface of fire-box	58 square feet.
Total	538 square feet.

The valve gear consisted of the Haigh Foundry pattern, having four fixed eccentrics. Engines of this class

THE LOCOMOTIVE.

worked with great efficiency upon the Grand Junction and other railways for many years.

Mr. T. E. Harrison, in December, 1836, designed, and during 1837-8, Messrs. Hawthorn constructed, two locomotives for the Great Western Railway. These engines had the cylinders and motion upon a separate frame and wheels from the fire-box and boiler.

One of these named, the "Thunderer," had wheels 6 feet diameter, but geared up, three to one, in order to be equal in effect to a wheel 18 feet in diameter.

The other, named "Hurricane," had a pair of driving-wheels 10 feet diameter, the largest ever made, illustrated (Fig. 46).

The boiler, fire-box, and frame upon which they were placed, also the tender, were of the same dimensions in each case. The cylinders and stroke were also similar.

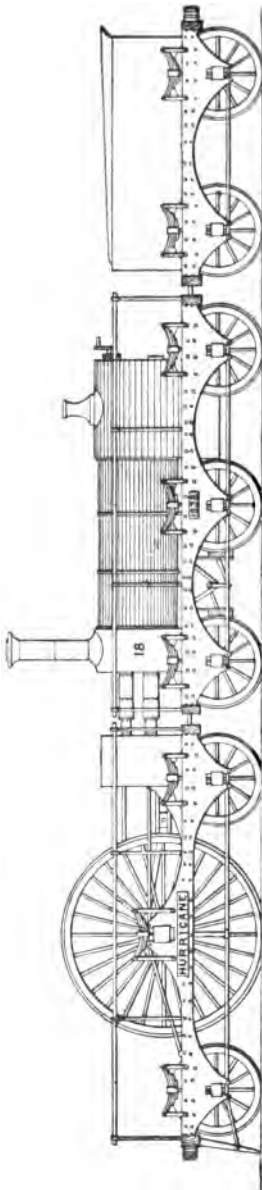

Fig. 46.—The "Hurricane," 1838.

The following are the dimensions of the "Hurricane."

Diameter of driving wheels	10 feet
Diameter of cylinders	16 inches
Length of stroke	20 inches

The boiler contained 135 brass tubes. The fire-box was of copper, and divided by a mid-feather.

Heating surface of tubes	516 square feet
Heating surface of fire-box	108 square feet
Total	624 square feet

Weight of the six-wheeled engine 11 tons, of which 6 tons rested upon the 10-foot driving wheels. The weight of the six-wheeled frame with the boiler and fire-box was 12 tons.

The steam from the boiler to the cylinders was conveyed by a jointed pipe and the exhaust steam was returned to the chimney by a similar pipe. The engine-driver stood upon the engine in front of the driving axle, and the fireman behind the fire-box in the usual way. Both of these extraordinary engines proved failures, one great cause being that there was so little weight available for adhesion.

An examination of Fig. 46 shows that the "Hurricane" had a good sound framing, and there is every reason to believe that if the boiler had been placed over the driving axle, instead of on an independent frame, the engine would have been considerably improved.

The Arbroath and Forfar Railway, when opened on the 3rd January, 1839, had a gauge of 5 feet 6 inches, and during the year 1838, Messrs. Stirling & Co., of Dundee, designed and constructed three locomotives for that line, named "Victoria" (Fig. 47), "Britannia," and "Caledonia."

Messrs. Stirling, having visited the Liverpool and Manchester Railway, and examined the "Swiftsure"

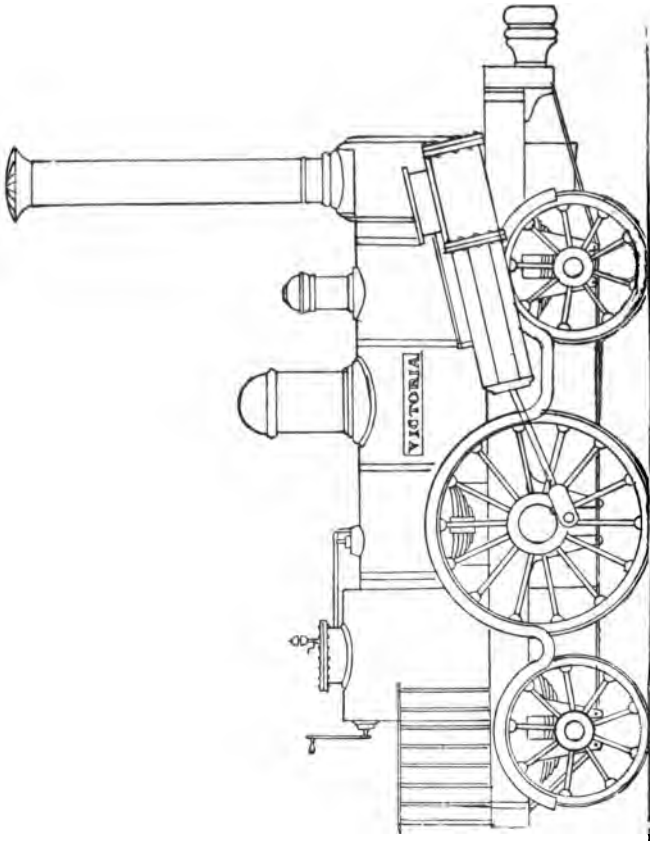

Fig. 47.—“Victoria,” built by Stirling & Co., 1838.

(Fig. 37), came to the conclusion that an outside frame was unnecessary. The Arbroath and Forfar engines were therefore the first to combine inside bearings,

outside cylinders, and six wheels; they had cylinders 12 by 18; driving-wheels 5 feet diameter. These locomotives worked very satisfactorily for many years, and until the line was leased to the Caledonian Company and the gauge altered to 4 feet 8½ inches.

The Haigh Foundry Company, Wigan, constructed

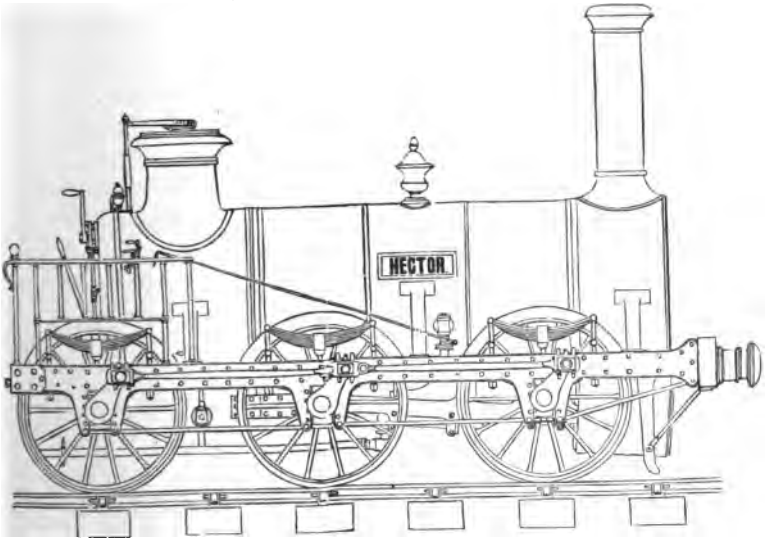

Fig. 48.—"Hector," No. 10, Leicester and Swannington Railway, September, 1839.

the "Hector" (Fig. 48), for the Leicester and Swannington Railway, and it commenced work upon that line, September, 1839.

"Hector" was a six-wheeled coupled goods engine, having cylinders 16 inches by 20 inches, and wheels 4 feet 6 inches diameter. Total heating surface, 688 square feet.

The valve gear was the "Haigh Foundry" pattern, having four fixed eccentrics, and forked ends to the eccentric-rods; the boiler was "clothed" with sheet iron plate instead of with polished wood, which was the usual practice at that time. The driving-wheels were without flanges. This locomotive was constructed to work with a steam pressure of 120 lbs. per square inch if necessary, but for the first few years it was only worked with 80 to 90 lbs. The urn-shaped vase upon the boiler contained a "lock-up safety valve" pressed to blow off at 91 lbs.

The "Hector," was regarded as such a powerful engine that invitations were issued to the locomotive officials of the other companies to witness its performance between Coalville and Bagworth, and as a result similar engines were ordered for the Manchester and Leeds, North Midland, Great Western, and Liverpool and Manchester Railways.

The first part of the Birmingham and Gloucester Railway was opened 24th June, 1840; this line was intended to form a portion of a great through-route between the north and west of England; it was, therefore, a very serious mistake on the part of the engineer, Captain Moorsom, to have designed and constructed the great Lickey incline of 1 in 37 for a distance of over two miles, extending from Bromsgrove to Blackwell, and it was an equal mistake to suppose that English locomotive builders could not construct an engine to ascend the incline. However, he ordered eight locomotives from Norris & Co., of Philadelphia, the first four to arrive being named "England," "Philadelphia," "Columbia," and "Atlantic." These engines had a four-wheeled leading bogie, a single

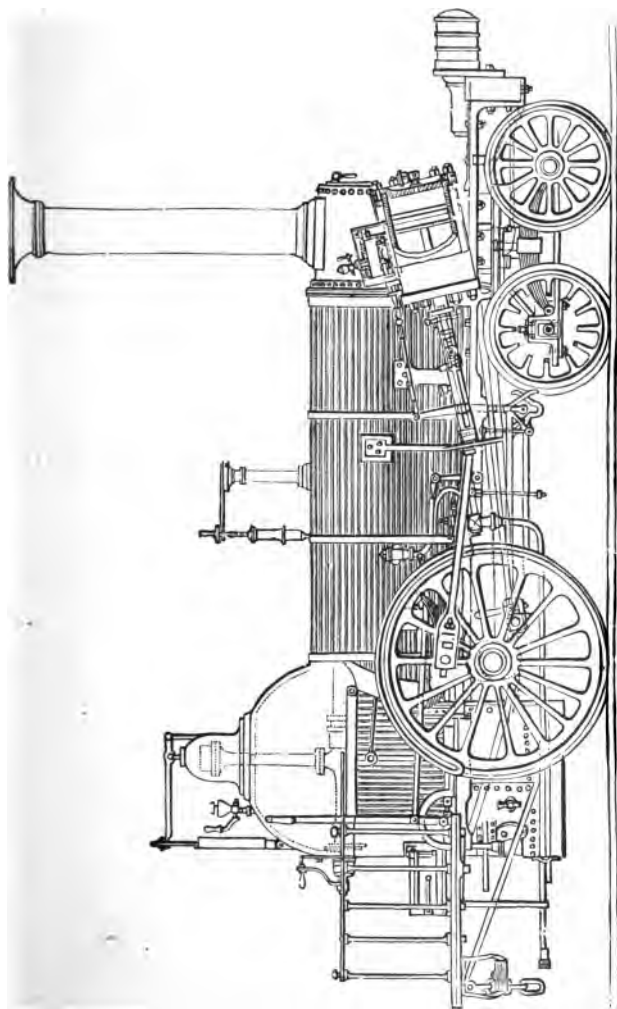

Fig. 49.—“Philadelphia,” Birmingham and Gloucester Railway, 1840.

pair of driving-wheels placed in front of the fire-box, and outside inclined cylinders.

Diameter of cylinders.. .. .	10½ ins.
Length of stroke	18 ins.
Diameter of driving-wheels	4 ft.
Weight in working order	9 tons 11¼ cwt.

Their usual performance up the "Lickey" was 33 tons at 12 to 15 miles per hour, 39½ tons at 10½ miles, or a maximum load of 53½ tons at 8½ miles.

One of these American engines having 11½ cylinders was lent for a few weeks for trial upon the Grand Junction Railway, when it was ascertained that it conveyed loads of 100 to 120 tons on an incline of 1 in 330 at 14 to 22½ miles per hour; or on an incline of 1 in 177 at 10 to 14 miles per hour. The mean of seven journeys from Birmingham to Liverpool, with gross loads of about 100 tons, showed a consumption of 50 lbs. of coke per mile, and an evaporation of 4·27 lbs. of water per pound of coke.

The American engines having worked with great success upon the Lickey incline for a few weeks, Mr. Edward Bury, of Wolverton, wrote to the directors "to declare that whatever American engines could do his could do," and sent the London and Birmingham Company's engine named "Bury" to prove his assertion.

Mr. Bury, himself driving, started from Bromsgrove, and humorously called to Mr. Gwynn, who had come with the American engines, to join him. "No," he replied, "it's no use, you'll soon come back again," and back again Mr. Bury and his engine came, having stuck before getting half-way up the incline.

In consequence of the taunts which appeared in an

American newspaper, that "the English could make inclines, but had to come to America for engines to work them," Mr. J. E. McConnell, the locomotive superintendent of the Birmingham and Gloucester Railway, obtained the sanction of his directors to construct a powerful tank engine at the Bromsgrove works, and it commenced duty in 1845.

This engine had six coupled wheels of 3 feet 9 inches diameter, cylinders 18 inches diameter, a stroke of 26 inches, and a total weight of 30 tons loaded. This engine worked successfully for a number of years.

Mr. Robert Stephenson's attention was given, early in the year 1842, to the fact that the chimneys and smoke-boxes were very quickly destroyed; he therefore made some experiments with North Midland Company's engines at Derby to ascertain the degree of heat which was escaping. First he placed tin in small iron conical cups and suspended them in the "smoke box," and it was found to disappear quickly; next, lead was tried in the same manner, and was found to melt nearly as easily; and, lastly, zinc was tried, which was soon driven off in vapour, clearly indicating a temperature of 773 degs. in the chimney, and showing that a great waste was taking place. To overcome this evil, Mr. Stephenson decided to lengthen the tubes of locomotives from 9 ft. to 13 or 14 ft., but he found that to obtain a patent for the invention he would have to employ an unlimited term, as to fix a length would be useless, as a few inches more or less would enable others to evade the patent; he therefore adopted the name "long boiler," and placed all the axles under the barrel or circular part of the boiler.

In the first of these "long-boiler" engines, the

driving-wheels were placed between the fore and hind carrying-wheels, the cylinders being kept forward to

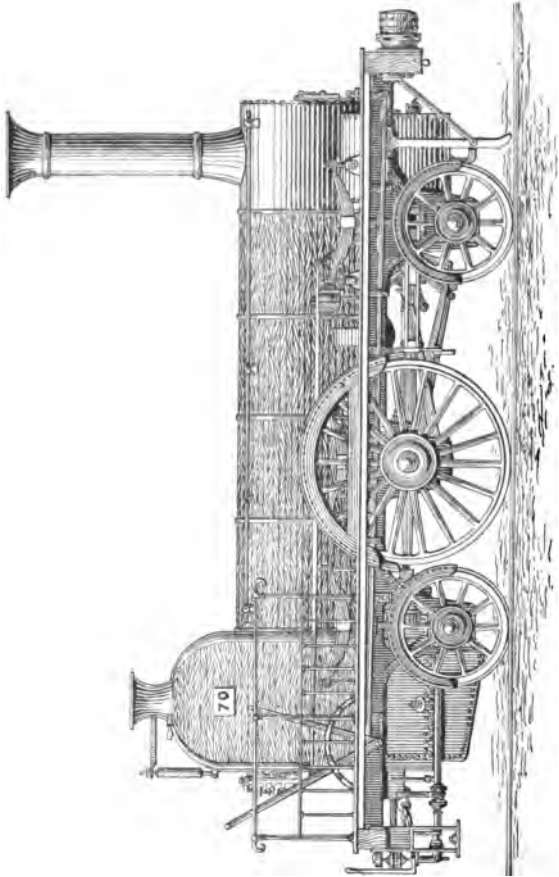

Fig. 50.—North Midland Railway, No. 70, 1842.

the outside of the smoke-box (Fig. 50). Several engines of this design were built for the North Midland Railway Company and other lines.

Further experiments at Derby in 1843 proved that the "long-boiler" was successful in reducing the heat in the chimney to very little over 442 degs., as upon placing tin in the smoke-box it was found just to melt at the corners.

In 1844 Mr. Robert Stephenson decided to place the four carrying-wheels in front and the driving-wheels close in front of the fire-box; in 1846 he added a pair of trailing wheels behind the fire-box, thus converting his long-boiler engine into an eight-wheeled locomotive.

In the year 1846 it was reported that at least 150 locomotives, according to this long-boiler pattern, were in constant use in this country and on the continental railways.

Valve-gear having loose eccentrics (described p. 45) was found to be far from satisfactory, and many other gears were tried—for instance, those of Carmichael, Hawthorn, Haigh Foundry, Stephenson, Gray, Dodd and others—but none of these fulfilled all that was necessary. The eccentric-rods in nearly all valve gears, previously to 1842, were provided with "forks" or "gabs," which engaged with pins attached to the arms of the valve rods. In practice these pins were frequently broken off.

Stephenson's valve-gear, generally known as "fork motion," is illustrated in Fig. 51, and shows the form of gear used by that firm between the years 1835 and 1842.

Mr. William Howe, who was a fitter in the employ of R. Stephenson and Co., decided to place a curved link between the ends of the forward and backward eccentric-rods to take the place of the forks. He

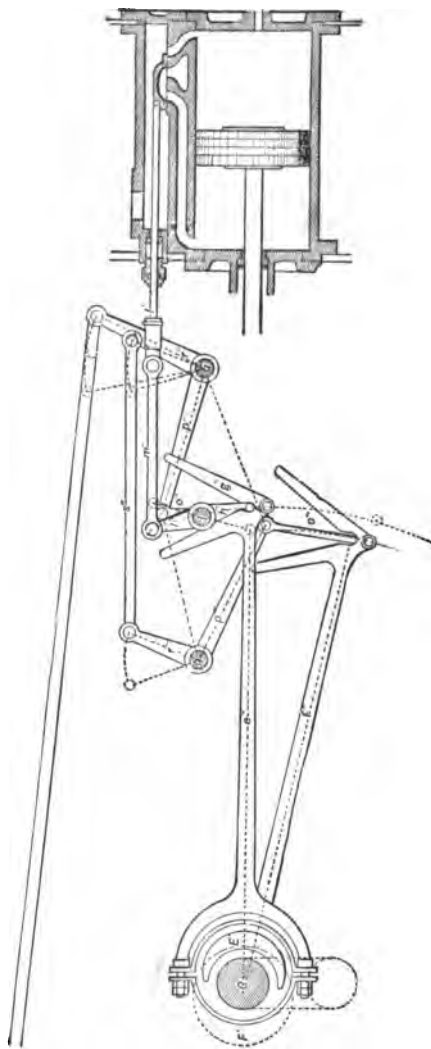

Fig. 51.—Stephenson's Fork Motion, 1835 to 1842.

made a pencil sketch and wooden model, which were shown to Mr. Robert Stephenson, who, seeing its merits, ordered it to be fitted to all engines constructed at his works. At that time (August, 1842) two locomotives were being built for the North Midland Railway, Nos. 70 and 71. No. 70 was already fitted with "fork motion," but No. 71 was supplied with Howe's link motion (Fig. 52), and commenced to run on September 10, 1842.

Some correspondents to newspapers have expressed the opinion that "the introduction of the 'link' was not an invention, but an improvement." By whichever name it be known, the fact remains that Mr. Howe's introduction of the link at once removed all the difficulties which had for years caused trouble with the "fork motion," and it did far more than this, by producing a complete and simple means of cutting off steam for expansive working.

It has also been contended that "the merits of the gear for 'cutting off' were probably not known at first." Now, as a fact, the reversing lever rack of the

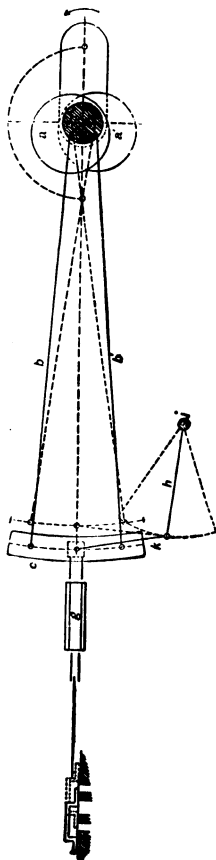

Fig. 52.—Howe's Link Motion, 1842.

first engine ever fitted with link motion had seven notches on either side of the centre, and steam could be cut off at various proportions of the stroke, from $4\frac{1}{2}$ inches to $17\frac{1}{2}$ inches. It is therefore perfectly certain that the expansive working of the gear was fully understood before the first engine left the Newcastle works, for had it not been intended to work expansively, "the seven notches on either side of the centre" would have been useless. There is also conclusive proof that the action of the gear was fully understood by Mr. Howe, for he came himself to the North Midland Railway with the engine No. 71 in order to instruct the engine-driver how to work his gear to the best advantage. Howe's link motion was at once adopted by nearly all locomotive builders, it is in use in all parts of the world, and to this day there is no valve gear to equal it. The "link motion" is frequently spoken of as Stephenson's, but this is an error, as Howe was the inventor, and Mr. R. Stephenson himself always spoke of it as Howe's.

Mr. Alexander Allan (whose death only took place in 1891) entered the service of the Grand Junction Railway Company, February, 1840, and took charge of that company's locomotive establishment at Edge Hill, Liverpool, under Mr. Buddicom, the chief mechanical engineer. From the copy of the official list in the writer's possession, it appears that, at the close of the year 1839, the Grand Junction Company possessed 59 engines. These all ran upon six wheels, had double frames and inside cylinders, 57 of them had "single" driving-wheels, and two, "Sirius," No. 30, and "Gorgon," No. 41, were the only "goods" engines, they having the leading and driving-wheels coupled.

Names and numbers of the Grand Junction Company's engines, 1837 to 1840 :—

1. Saracen.	21. Wizard.	41. Gorgon.
2. Hecla.	22. Basilisk.	42. Sunbeam.
3. Shark.	23. Vizier.	43. Vampire.
4. Hecate.	24. Sirocco.	44. Harlequin.
5. Falcon.	25. Harpy.	45. Sybil.
6. Stentor.	26. Æolus.	46. Medea.
7. Scorpion.	27. Merlin.	47. Vulture.
8. Wildfire.	28. Prometheus.	48. Oberon.
9. Alecto.	29. Alaric.	49. Columbine.
10. Dragon.	30. Sirius.	50. Hornet.
11. Zamiel.	31. Pegasus.	51. Torch.
12. Centaur.	32. Tamerlane.	52. Diomede.
13. Prospero.	33. Erebus.	53. Clio.
14. Witch.	34. Phœbus.	54. Medusa.
15. Phalaris.	35. Talisman.	55. Lucifer.
16. Lynx.	36. Thalaba.	56. Phantom.
17. Caliban.	37. Hawk.	57. Sultan.
18. Cerberus.	38. Camilla.	58. Syren.
19. Dr. Dalton.	39. Tartarus.	59. Vandal.
20. Eagle.	40. Jason.	60. Tantalus.

Upon taking charge, Mr. Allan found that three engines, namely, "Æolus," 26, "Tartarus," 39, and "Sunbeam," 42, were in a very bad condition, having broken crank-axles and defective framings; he therefore decided to rebuild them.

Mr. Allan's experience as manager of Messrs. Forrester's works had led him to become an advocate of outside cylinder engines; he therefore converted the three above-mentioned engines from inside cylinder to outside; the leading and trailing wheels had outside bearings as previously, but the driving-wheels had the outside bearings removed, and the connecting-rod placed direct upon a crank-pin upon the boss of the wheel. The broken crank-axle was of course in each case replaced by a straight axle.

The first of these rebuilt engines, "Æolus," was put to work towards the close of the year 1840, "Tartarus" and "Sunbeam" following in 1841. At this period the Grand Junction Railway Company decided to build locomotive works at Crewe, and to construct its own engines. The Crewe works were opened early in the year 1843, Mr. Allan taking charge thereof as superintendent, Mr. F. Trevithick being the company's chief mechanical engineer.

Mr. Allan designed and constructed the passenger engines upon the model of the rebuilt "Æolus," and employed driving-wheels of 5 feet 6 inches and 6 feet diameter, the cylinders placed outside, being 15 inches and the stroke 20 inches.

The goods engines (Fig. 53) were of a similar design, but the driving and trailing wheels were 5 feet diameter and coupled, the cylinders being outside and 15 × 20.

These two classes became generally known as the "Crewe pattern," and when, on July 16, 1846, the Grand Junction, London and Birmingham, and Manchester and Birmingham companies amalgamated and became the London and North-Western Railway, Mr. Allan continued to build his Crewe pattern for the northern division of that railway. He was also the inventor of the "Allan straight link motion."

The goods engines (Fig. 53) were 22 feet 5 inches in length over buffers, and their weight in working order 19½ tons; they conveyed the goods and mineral traffic on the northern division of the London and North-Western Railway for many years, and, when superseded by Mr. Ramsbottom's six-coupled engines, they were converted into tank engines for

branch passenger traffic, and some of them are at work at the present day.

During the year 1843 the London and South-Western Railway adopted outside cylinder engines of similar design to those introduced upon the Grand Junction Railway at Crewe. The locomotive superintendent, Mr. John V. Gooch, constructed some of these engines with driving-wheels of 6 feet 6 inches, and others with

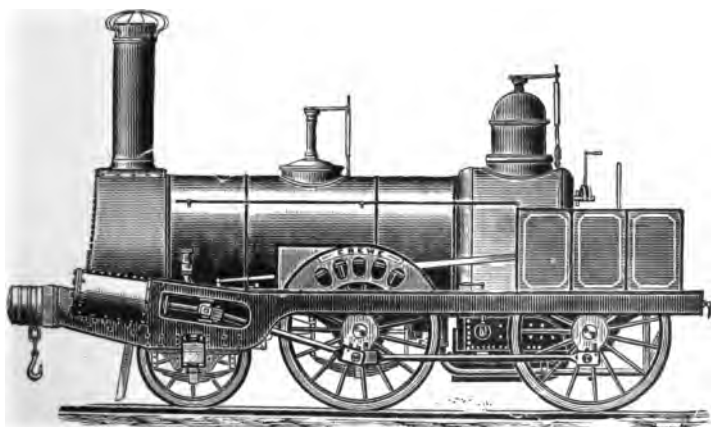

Fig. 53.—Mr. Allan's Goods Engines, Crewe Works, 1843 to 1857.

7 feet wheels, the largest then in use on the narrow gauge.

In December, 1845, a series of experiments was conducted upon the Great Western Railway, between London and Didcot, with an engine named "Ixion" having inside cylinders $15\frac{3}{4}$ inches diameter and 18 inches stroke; four carrying-wheels; driving-wheels, 7 feet diameter; grate, 13.4 feet; surface of fire-box, 97 feet; tubes, 2 inches diameter, 131 in number, surface

732 feet; total heating surface, 829 feet; weight, empty, 22 tons; weight of tender, empty, 8 tons. This engine attained a maximum speed of 62 miles per hour with an average load of $76\frac{1}{2}$ tons, and an average speed of 50 miles on a trip of 53 miles; the coke consumed was at the rate of 35.3 lbs. per mile, and water evaporated 201.5 feet per hour.

Mr. T. R. Crampton took out a patent in 1843 for an arrangement or position of locomotive wheels, in which the small, or carrying-wheels, were placed in front and the large driving-wheels at the trailing end, behind the fire-box; the cylinders being outside. It was claimed that this design solved the problem of obtaining a large driving-wheel with a low centre line of boiler. (The idea, however, was not quite new, as in 1833 Mr. Baldwin, in America, constructed several engines having the driving-wheels behind the fire-box.)

During the year 1846 Messrs. Tulk and Ley constructed two engines at the Lowca works, Whitehaven, from the designs of Mr. Crampton, for the Namur and Liège Railway, and they were named "Namur" and "Liège."

These engines ran upon six wheels, and had outside cylinders, 16 × 20, and a pair of 7 feet driving wheels placed behind the fire-box.

In practice the performance of these two engines was found to be equal to a load of 80 tons, exclusive of engine and tender, at 51 miles per hour on a level; and 50 tons at 62 miles per hour on the level.

Before exportation the "Namur" was tried experimentally upon the London and North-Western Railway, and attained a higher speed than any broad-

gauge locomotive at that period; this result giving the greatest satisfaction to the narrow-gauge advocates.

In 1846 Messrs. Stephenson and Howe patented a three-cylinder locomotive having two outside and one inside cylinder in order "to counteract the alternate lifting on the opposite side of the engine." Two of these engines were constructed and tried experimentally; they worked satisfactorily. As is the case with the three-cylinder locomotives in use at the present day, these engines had three sets of motion to be provided and maintained; however, when new they ran at a higher speed than the broad-gauge engines.

At this period the battle of the gauges was at its height and the rivalry was most keen; the Royal Commission had been appointed July, 1845, to decide between the "broad" and "narrow" gauges.

During the years 1838 to 1845, Mr. Bury was strongly urged by the narrow-gauge advocates to build some larger engines for the London and Birmingham Railway in order to compete with the Great Western Railway. This, however, he firmly refused to do, and was perfectly content to continue to place the small four-wheeled engines on that line, and a list now before us shows that even in August, 1845, the company had 89 four-wheeled engines and one six-wheeled ballast engine. There can be no question that the broad gauge gained many friends, in London especially, on account of Mr. Bury continuing to run small four-wheeled engines to London. The advocates of the broad gauge, of course, urged the public to compare the large six-wheeled engines at Paddington with the little four-wheelers at Euston. Thus it

will be seen that Mr. Bury, although himself opposed to the broad gauge, by his policy played into the hands of the broad-gauge advocates ; indeed it was remarked at the time that Mr. Bury did more harm to the narrow gauge cause than any of its enemies.

The narrow-gauge engines were successfully maintaining their position (upon every line but the London and Birmingham), and proving that whatever could be done upon the 7 feet gauge could be equally well done on the 4 feet $8\frac{1}{2}$ inches gauge. It therefore became necessary for the Great Western Company to make some "striking improvement" in order to show what could be obtained upon the broad gauge, and Mr. (afterwards Sir Daniel) Gooch, the company's locomotive superintendent, accordingly designed and constructed at the Swindon works a new and very powerful class of express engine which he regarded as the "ultimatum" for the broad gauge.

The first of this class was named "Great Western," built April, 1846, having then six wheels.

The engine (Fig. 54) has eight wheels—namely, four leading-wheels arranged in a group (but not in a bogie), a single pair of driving-wheels 8 feet diameter, having no flanges, and a small trailing pair of wheels. The cylinders 18 by 24, 300 tubes, and 1,767 square feet of heating surface. The valve gear was the well-known fixed link motion introduced by Mr. Gooch.

This splendid locomotive was highly successful, and was found capable of evaporating 300 cubic feet of water per hour, and it is a noteworthy fact that engines of this class appear to be among the most economical ever run, the consumption of coal being as low as $2\frac{1}{2}$ lbs. per horse-power per hour.

This engine upon several occasions started from Paddington and stopped at Didcot, $53\frac{1}{4}$ miles, in forty-seven minutes, and obtained a maximum speed of 78 miles an hour.

Twenty-nine locomotives were built between 1847 and 1855 of similar construction to that shown in Fig. 54, except that they had not the dome over the

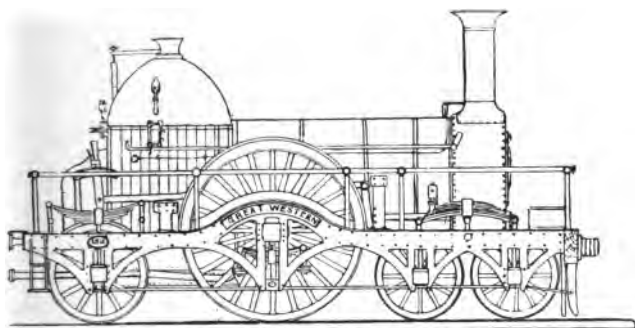

Fig. 54.—“Great Western,” 1846, showing the engine after it had been converted from six to eight wheels, and as it ran until 1870.

fire-box. (See also the illustration given in Fig. 106, p. 208.)

Through the courtesy of Mr. William Dean, locomotive superintendent of the Great Western Railway, the subjoined complete list of the thirty engines is given (see next page), showing the miles run before they were “rebuilt” or replaced by entirely new engines bearing the old names. One of those named in the list—the “Lord of the Isles,” built 1850—was sent to the Exhibition of 1851, as well as to the Edinburgh Exhibition of 1890, and to the Chicago Exhibition of 1893.

BROAD GAUGE ENGINES, "GREAT WESTERN" CLASS.

Name of Engine.	Builder.	Date.		Total mileage before renewal.
		Built.	Condemned or rebuilt.	
Great Western	G. W. R.	April 1846	Dec. 1870	370,687
Iron Duke	"	" 1847	Oct. 1871	607,412
Lightning	"	" "	April 1878	816,601
Great Britain	"	July "	Oct. 1880	408,644
Emperor	"	Sept. "	June 1873	690,225
Paaha	"	Nov. "	" 1876	613,038
Sultan	"	" "	Aug. "	727,300
Courier	"	June 1848	Nov. 1877	746,120
Tartar	"	July "	Aug. 1876	731,817
Dragon	"	Aug. "	Dec. 1872	670,757
Warlock	"	" "	June 1874	639,410
Wizard	"	Sept. "	Nov. 1875	711,908
Rougemont	"	Oct. "	Aug. 1879	772,401
Hirondelle	"	Dec. "	May 1873	605,010
Tornado	"	March 1849	March 1881	688,000
Swallow	"	June "	Aug. 1871	569,232
Timour	"	Aug. "	Nov. "	569,893
Prometheus	"	March 1850	June 1870	538,025
Perseus	"	June "	Dec. 1880	722,458
Estafette	"	Sept. "	June 1870	504,544
Rover	"	" "	" 1871	461,344
Amazon	"	March 1851	July 1877	729,840
Lord of the Isles (built 1850, commenced work July, 1852)	"	July 1852	July 1881	789,300
Alma	Rothwell	Nov. 1854	June 1872	444,600
Balaclava	"	Dec. "	Nov. 1871	406,425
Inkermann	"	March 1855	Oct. 1877	650,220
Kertch	"	April "	Dec. 1872	326,246
Crimea	"	May "	Sept. 1878	605,701
Eupatoria	"	" "	Oct. "	618,275
Sebastopol	"	July "	" 1880	707,148

With the removal of the broad gauge on 23rd May, 1892, the whole of this type of engine necessarily ceased work.

Mr. Bodmer, in 1845, built an engine for the Brighton Railway, No. 7, having his system of patent double pistons moving in opposite directions, but it proved a failure and was rebuilt.

In 1846, Mr. Gray, Locomotive Superintendent of the London and Brighton Railway, designed, and Messrs. Hackworth & Co. constructed, engines for that line having inside cylinders, an outside frame and outside bearings for the leading and trailing wheels,

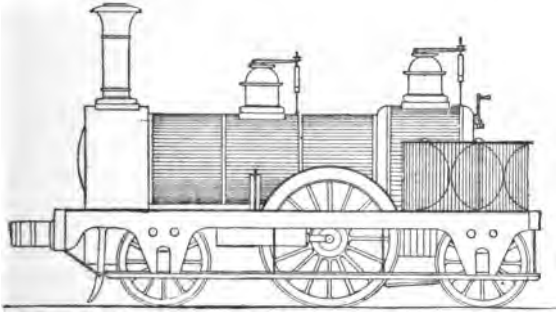

Fig. 55.—London, Brighton, and South Coast Railway. No. 53, November, 1846. Designed by Mr. Gray and built by Hackworth & Co.

but inside bearings only for the driving axle. These engines are an important link in history, and prove that Mr. Gray was in advance of Wilson's "Jenny Lind" type.

During the time that the last (fifth) edition was in the press, considerable discussion took place in the engineering papers relating to the rival claims of Mr. Gray and of Messrs. Wilson and Fenton; and by the courtesy of the editor of *The Engineer*, the

illustration of Gray's engine is given, Fig. 55, and it is only necessary to compare this diagram with Fig. 108, in order to see at a glance that the London, Brighton, and South Coast Company's engines by Mr. Gray, Nos. 49 to 60 inclusive, were the forerunners of Wilson's engines, Nos. 61 to 70, which afterwards followed and are illustrated, Fig. 108.

In 1847, Messrs. E. B. Wilson & Co., of Leeds built the "Jenny Lind" (Fig. 108), for the London and Brighton Railway, having cylinders 15 by 20 and wheels 6 feet diameter. Large numbers of these engines were built for the Brighton, Midland and other railways.

At the same date, 1847, Messrs. E. B. Wilson & Co., of Leeds, built a trial engine for Mr. Crampton, in which he employed four large driving-wheels of 6 feet 6 inches diameter, placed at a distance of 16 feet between centres. By means of outside coupling rods motion was communicated from the intermediate shaft to the four driving-wheels. This engine weighed 32 tons, or 8 tons upon each wheel, which proved too much for the permanent way of that period. This engine was tried by Mr. Crampton upon the Midland Railway, and attained a speed of fully 75 miles an hour. It was also tried on other lines, but no railway company would purchase it on account of its great weight. Another engine of similar design was built, but much lighter. It ran upon the York, Newcastle, and Berwick line for some years. (See page 214.)

The success of the "Great Western" (Fig. 54) at once caused the narrow-gauge lines to require larger engines. The London and North-Western Company gave orders to Messrs. Tulk and Ley for an

engine, designed by Mr. Crampton; it was placed on the line in 1847, and named the "London"; this engine had cylinders 18 by 20, a single pair of 8 feet driving-wheels and 1,529 square feet of heating surface; and it was claimed that with a light load she attained a speed of fully 74 miles an hour. The directors of the London and North-Western also gave instructions for the construction, at Crewe works, of three experimental engines:—

The "Courier," designed by Mr. Crampton, having a pair of 7-foot wheels placed behind the fire-box;

The "Velocipede," designed by Mr. Alexander Allan, the superintendent of the Crewe works, having a pair of 7-foot wheels; and

The "Cornwall," by Mr. F. Trevithick, the chief mechanical superintendent of the northern division; and they were all completed in 1847.

The "Courier" was a very similar engine to the "Namur" and others of Mr. Crampton's design.

Mr. Allan, of Crewe, held the opinion that the "battle of the gauges" was an absurdity, and that it was not wise to build engines simply to see *what could be done*; he therefore built the "Velocipede" (Fig. 56).

This engine had cylinders 15 by 20 and 7 feet wheels, and this class of engine proved highly successful in daily working on the northern division of the London and North-Western.

On the other hand Mr. F. Trevithick considered it a matter of the most vital importance that the "narrow gauge" should eclipse the performance of the broad gauge; he therefore decided to have a driving-wheel six inches larger than the "Great

Western" (Fig. 54). In order to obtain a large driving-wheel and a low centre of gravity, he adopted the peculiar plan of placing the boiler *under* the driving axle. The driving-wheel of the "Cornwall" he designed of 8 feet 6 inches diameter, that being the largest size which had then, or has since, been tried upon the ordinary 4 feet 8½ inches gauge, the cylinders being 17½ inches diameter, and 24 inches stroke. The

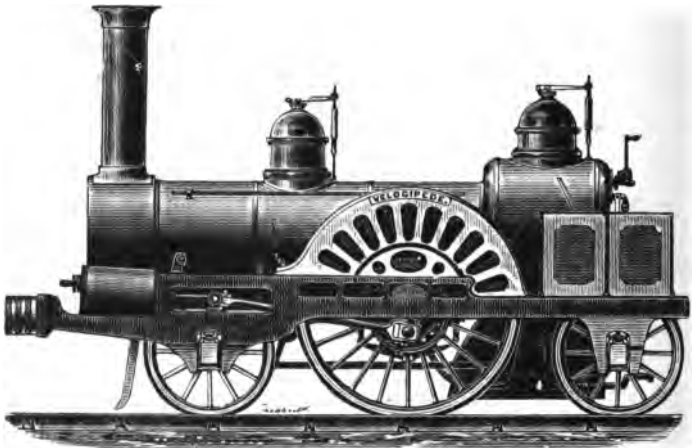
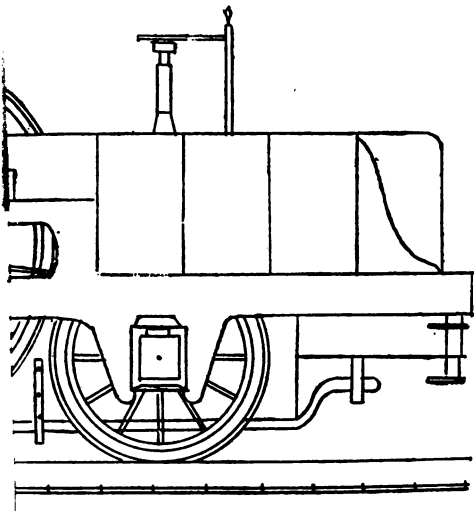

Fig. 56. — "Velocipede." (Northern Division), No. 187,
Crewe Works, Oct., 1847.

engine (Fig. 57) appears to have fully answered the expectation of her designer, for upon her trial trip a speed of fully 79 miles an hour was attained under favourable circumstances, thus beating the "Great Western" by one mile per hour.

This locomotive engaged very considerable attention at the Exhibition of 1851, but no engineer favoured the position of the boiler, and about 1862—1863, Mr.



uilt November, 1847, and as running till 1862.

[*To face p. 100.*]



John Ramsbottom constructed a new boiler and placed it *above* the axle.

Fig. 58 illustrates this fine engine as thus altered, and as it is running to-day.

The "Cornwall" is still working the "45 minute" expresses between Manchester and Liverpool, and carries us back to the year 1847, or for a period of nearly 56 years. It has now the largest wheel in the world, and it is stated that with a load equal to her power she

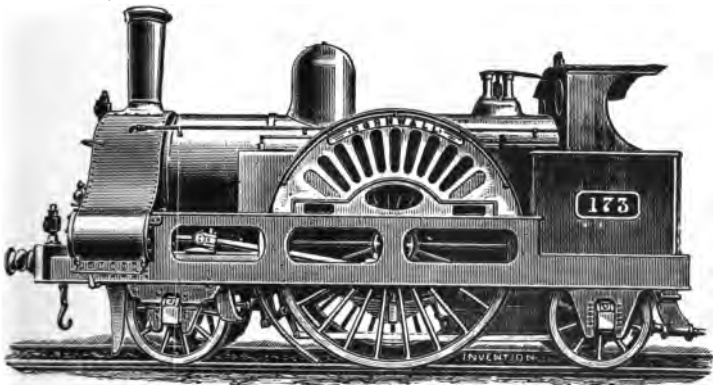

Fig. 58.—"Cornwall," London and North-Western Railway, 1863 to 1903
(Now, No. 3020.)

is capable of running at the highest possible speed yet attained.

The "Cornwall" appears capable of several years' more work, and, ultimately, when it rests from its labours it is understood that it is to be preserved as a relic of early locomotive construction.

Another large narrow-gauge engine intended to surpass the "Great Western" (Fig. 54) was designed by Mr. T. R. Crampton, and built by Messrs. Bury,

Curtis and Kennedy, of Liverpool, for the London and North-Western Railway, 1848, and named the "Liverpool" (Fig. 59), an engine generally considered as the "ultimatum for the narrow gauge."

The "Liverpool" had cylinders 18 inches diameter, 24 inches stroke; 292 tubes of $2\frac{3}{8}$ inches external diameter and 8 of $1\frac{3}{4}$ inch, 12 feet 6 inches long; surface of fire-box 154.434 feet; of grate $21\frac{1}{2}$ feet; of tubes 2136.117 feet; total heating surface 2,290 feet; two driving-wheels 8 feet diameter; 6 carrying-wheels 4 feet

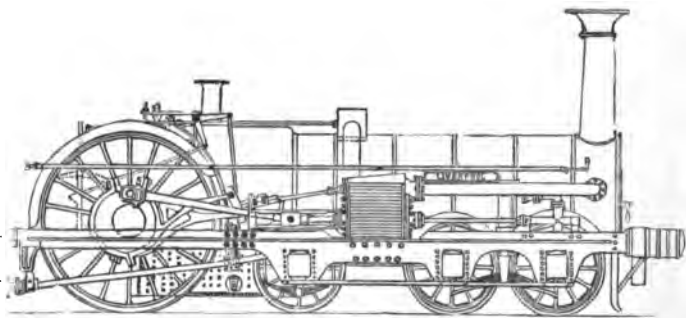

Fig. 59.—"Liverpool," London and North-Western Railway, 1848.
(Southern Division, No. 245.)

diameter; length between centres of extreme wheels 18 feet 6 inches; total length of engine 27 feet; weight of engine, charged, 35 tons, or 12 tons on the driving-wheels, 17 tons on the four leading wheels, and 6 tons on the two intermediate wheels; weight of tender 21 tons; total weight 56 tons. This engine conveyed the express trains between London and Wolverton for some time, and in one case took 40 carriages within time, thus exceeding the combined duty of three ordinary engines; and when tested for "speed" with

a light load, the late Mr. Crampton informed the writer that it attained fully 79 miles an hour.

The permanent-way at that time was not strong enough to carry such a large engine, its weight and long rigid wheel-base therefore caused it to gradually retire from active service.

Had the rail-joints been "fished," and the four front wheels placed in a bogie frame, this would have been one of the most successful engines.

Messrs. Sharp Brothers, 1848-9, built ten passenger engines for the Midland Railway, Nos. 60 to 69. The first six of these had cylinders 16×20 , and driving-wheels 5 feet 6 inches diameter for the ordinary gauge. The Midland Company, having purchased the Bristol and Gloucester Company's line, required some broad-gauge engines to work thereon. Four of the engines by Sharp were therefore built "convertible"; they were, in fact, narrow-gauge locomotives having very long axles, and the wheels were placed quite outside the axle-boxes. The cylinders were 16×20 , driving-wheels 6 feet 6 inches. Some years later, when the Midland Company removed the broad gauge between Bristol and Gloucester, the axles were shortened and the wheels placed between the double frames in the ordinary way.

Shortly after the construction of the "Liverpool" Mr. T. R. Crampton, in 1849, designed a locomotive having inside cylinders but the driving-wheels fixed to a straight axle. He employed a double-cranked shaft, having also outside cranks and coupling-rod to communicate motion to the driving-wheels, which were placed behind the fire-box. Eight of these engines were ordered from Messrs. R. Stephenson and Co., and placed upon the South-Eastern Railway, and one of

these, the "Folkestone," was sent to the Exhibition of 1851. Engines of this class took 44 tons at an average speed of $65\frac{1}{2}$ miles an hour, and attained $73\frac{1}{2}$ miles per hour upon a falling gradient of 1 in 264; they were, however, not satisfactory, and were rebuilt with driving-wheels upon the driving-shaft.

Mr. Ross Winans, in 1849, constructed a celebrated engine at his Locomotive Works, Baltimore, for the Baltimore and Ohio Railroad. It had a four-wheeled leading bogie, a single pair of driving wheels 7 feet diameter, and a trailing bogie; the cylinders were placed outside. This engine was named the "Charles Carroll of Carrollton." It worked satisfactorily and ran at very high speed, but it proved too heavy for the very light track over which it had to run.

The past few pages have shown that during the "battle of the gauges" several remarkable engines were constructed simply to attain excessive speed, and to show what could be done on this or that gauge; some of these which worked well experimentally were practically unsuitable for the ordinary traffic.

The folly of this policy having at last made itself apparent, "the battle of the gauges" ended, and the various locomotive builders settled down to the construction of good useful engines, capable of working the ordinary trains of that period. Each builder or designer adopted a standard pattern of passenger engine, and although they were very similar in general design the special features of each were most marked; and even at the present day, no matter how much one of these old engines has been rebuilt, the original maker can be clearly determined by an examination of those parts which were made a speciality.

Mr. J. E. McConnell, in 1844—5, designed and con-

structed at Bromsgrove some engines for the Birmingham and Gloucester Railway Company, in which he employed inside frames and inside bearings only. These small engines proved so satisfactory, that when he became locomotive superintendent of the southern division of the London and North-Western Railway, he retained the same design and built a large number of engines at Wolverton of the well-known "Bloomer" type. Some of these had cylinders 16×22 and

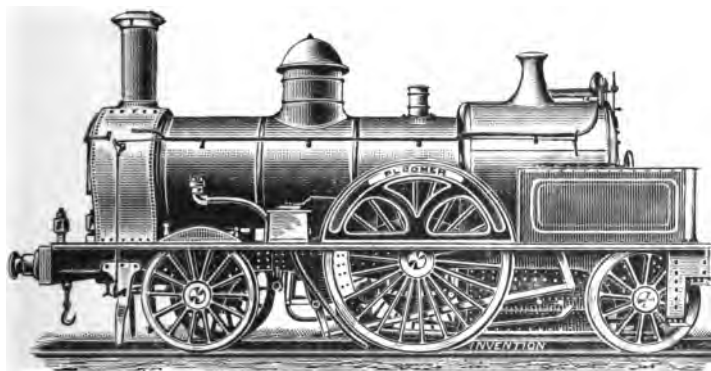

Fig. 60.—"Bloomer," Class 1850, L. & N.W.R., Southern Division.

6 feet 6 inches wheels—others similar to Fig. 60 had 7-foot wheels.

In November, 1852, Messrs. Fairbairn & Sons constructed a still larger engine from Mr. McConnell's design, for the southern division of the London and North-Western Railway, No. 300, having cylinders 18×24 , and driving wheels 7 feet 6 inches, the boiler being provided with his system of combustion chamber. This engine had double frames, and all the axles had *outside* axle-boxes, and weighed 31 tons.

Mr. McConnell also employed his patent design of boiler for the Wolverton goods engines, and placed all the six-coupled wheels under the barrel of the boiler.

It will have been observed that locomotive engineers for years had tried their utmost to obtain a large driving-wheel and a low centre of gravity. Mr. McConnell, however, disagreed most strongly with the "low boiler" theory, and maintained that a high boiler was no objection, and that engines having the highest boilers could run with the greatest steadiness. At that time his opinion was simply laughed at, now we see that he was correct, and only had the misfortune to be about thirty years in advance of his time.

During the year 1853, the London and North-Western Company employed Messrs. Woods and Marshall to test the efficiency of the Crewe and Wolverton engines (see Figs. 55 and 60), the result being that both were continued. It was strange that one company should continue to employ two locomotive superintendents and construct such different patterns of engines.

During the early part of the year 1852, Messrs. R. Stephenson and Co. constructed six express engines for the Midland Railway, having double frames, inside cylinders 16 by 22, and driving-wheels 6 feet 6 inches; they were numbered 130 to 135 inclusive. One of these remained in use till 1892, and in 1853 Messrs. Sharp, Stewart & Co. built ten express engines for the same line having cylinders 16 × 22, and a single pair of 6 feet 6 inch driving-wheels, Nos. 120 to 129.

Mr. Archibald Sturrock, locomotive superintendent of the Great Northern Railway, in 1853 designed, and

Messrs. R. & W. Hawthorn built, a large express engine for that line, No. 215. This engine ran upon eight wheels, four in a group, but not in a bogie, a single pair of driving-wheels 7 feet 6 inches diameter, and a pair of trailing wheels. The cylinders were inside, 17 × 24, and the engine had double frames. This engine appears to have been broken up about 1870, for at that date a new engine, No. 92, was built, having the old 7 feet 6 inch wheels, cylinders, and some other parts from old 215. No. 92 is still at work.

Mr. Pearson, the locomotive superintendent of the Bristol and Exeter Railway, and a very strong advocate of the broad gauge, "could not rest to think the narrow-gauge "Cornwall" (Fig. 56) had the largest wheel and attained the greatest speed." He therefore designed, and Messrs. Rothwell and Co., of the Union Foundry, Bolton, constructed, a class of broad-gauge tank engine in 1853 which ran upon 10 wheels, namely, a leading bogie, a single pair of driving-wheels 9 feet diameter, and a trailing bogie; the cylinders were $16\frac{1}{2} \times 24$, the driving-wheels were without flanges. The driving-axle was placed above the framing. The boiler contained 180 tubes of $1\frac{1}{8}$ inch diameter; the total weight of the engine in working order was 42 tons. The author remembers that at a speed of about 60 miles an hour the engine was remarkable for its very easy riding. American engineers have always maintained that these double bogie engines were a larger repetition of the Winans "Carroll" of 1849.

Mr. Pearson many years ago informed the writer that his engines had been officially tested at 81 miles an hour, and that the average consumption of

coke over a distance of 100,000 miles was only $21\frac{3}{4}$ lbs. per mile.

In the year 1876 one of this class of engine ran off the line at Long Ashton, after which the driving-wheels were all reduced to eight feet and tenders were added. A few of these celebrated engines as altered were running until May, 1892.

In 1855 Mr. Gooch placed a new class of engine upon the Great Western Railway which had been constructed from his designs by Messrs. R. Stephenson; they were named "Lalla Rookh," "Ivanhoe," "Robin Hood," "Rob Roy," "Waverley," "Cœur de Lion," "Pirate," "Abbot," "Red Gauntlet," and "Anti-quary."

These engines had inside frames only—four leading wheels in a group and two pairs of 7 feet coupled wheels. These were the largest driving-wheels ever coupled at that time. Only ten of these engines were built, and after running an average distance of about 500,000 miles each, it was not considered expedient to rebuild them.

Between the years 1853 and 1860 very much attention was given to the subject of burning coal instead of coke in locomotives. Messrs. Beattie, McConnell, Cudworth, and others, constructed most complicated fire-boxes and boilers having mid-feathers, combustion-chambers, or special forms of "grate."

All these proved perfectly unnecessary, for it was found by experiment on the Midland Railway that a brick-arch placed in the ordinary fire-box below the tubes; a deflector or baffle-plate within the door; a fire-door by which the supply of cold air can be properly regulated, and a steam-jet or blower in the

chimney, were all that were required to effectually consume the smoke in a locomotive.

At this period of locomotive history reference must be made to the works of a well-known engineer, who in times past took, and who still takes, an important part in the work. The Manchester and Birmingham Railway (or, more correctly, the line from Manchester to Crewe) had its locomotive department at Longsight, near Manchester, and as far back as May, 1842, Mr. John Ramsbottom was appointed as locomotive superintendent of that company. Upon the amalgamation, in 1846, he continued to hold the same position under the name of district superintendent of the north-eastern division of the London and North-Western Railway; and on August 1, 1857, we find him taking charge, as locomotive superintendent, of the northern division of the North-Western Railway, at Crewe works, in succession to Mr. Trevithick.

In the autumn of 1858, Mr. Ramsbottom turned out at the Crewe works a number of his new goods engines, having inside frames and inside bearings only, inside cylinders 17 inches by 24 inches, and six coupled wheels of 5 feet diameter; and in the following year, November, 1859, he placed his first express engine (Fig. 61) upon the northern division; it was named "Problem," and is still at work.

The "Problem" type, of which sixty were built between the years 1859 and 1865, all of which are still running, had cylinders 16 inches by 24 inches.

Diameter of driving-wheels (new)	7 ft. 7½ ins.
Weight of engine in working order	27 tons.
Weight of tender in working order	17½ tons.
Total	44½ tons.

“ Problem ” was also the first engine in this country fitted with Giffard’s injector for feeding the boiler.* An engine of this class, named “ The Lady of the Lake,” was sent, when quite new, to the Exhibition of 1862, and was awarded the bronze medal, which it still carries. Mr. Ramsbottom also received a medal for his system of troughs between the rails, by which engines could, and do, pick up water when running.

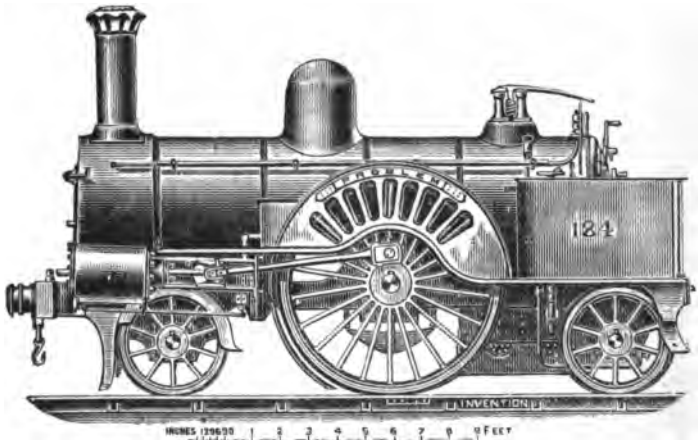

Fig. 61.—“ Problem,” London and North-Western Railway, Northern Division, November, 1869.

This latter appliance proved of considerable value on January 5th, 1862, when an exceptionally fine and important run was made from Holyhead to Euston, the occasion being when answers were brought to the despatches sent by the English Government to Washington, requiring the immediate surrender of Messrs. Mason and Slidell, who had been taken off an English ship, the *Trent*. An engine of the “ Problem ”

* For particulars as to the injector, see p. 192.

type (Fig. 61), by means of the water-trough, ran from Holyhead to Stafford, $130\frac{1}{2}$ miles, without stopping, and occupied only 145 minutes, and another engine went forward to London; the whole distance, 264 miles, being performed in five hours, with only one stop; and on certain favourable parts of the line several miles were run at a rate of "just under, if not quite, 80 miles an hour."

It is also a fact worthy of note that in the great railway race of 1888, when it was required to run through without stopping, at the highest speed, from London to Crewe, the old engines of the "Problem" type, namely, "Waverley" and "Marmion," ran the racing trains. All the sixty engines of the class are now from 27 to 33 years old, but with a light load in proportion to their power they are at the present day capable of running as fast as any locomotive now at work on any railway in this country.

Mr. McConnell, at Wolverton, in 1861, constructed three very large engines of the "Bloomer" type, named "Delamere," "Caithness," and "Maberley," one of which, No. 373, engaged much attention at the Exhibition of 1862; their chief dimensions being,

Diameter of cylinders	18 ins.
Length of stroke	24 ins.
Diameter of driving-wheels (new)	7 ft. $7\frac{1}{2}$ ins.
Heating surface of fire-box	242.5 sq. ft.
Heating surface of tubes	980.3 sq. ft.
Total	1222.8 sq. ft.

The fire-box was constructed to burn coal, and had a combustion chamber.

Working pressure of steam	150 lb. per sq. in.
Height of centre line of boiler above the rails	7 ft. $5\frac{1}{2}$ ins.
Weight upon driving-wheels	14 tons.

	Tons.	cwts.
Total weight of engine in working order	34	14
Weight of tender loaded	25	0
	<hr/>	
Total	59	14

From these details it will be seen that these three engines were very fine specimens, and that Mr. McConnell successfully solved the problem of large wheels, large inside cylinders, high steam pressure, and high boiler. He proved that a high boiler was no objection, and that engines having the highest boilers can run with the greatest steadiness; he also proved, in 1861, that with a light load these engines could under very favourable circumstances run "*within a fraction of 80 miles an hour.*" Towards the close of the year 1861 Mr. McConnell resigned, and Wolverton was closed as a locomotive building establishment, Mr. Ramsbottom, of Crewe, in the early part of the year 1862, being appointed locomotive superintendent of the whole line.

Messrs. Neilson & Co. constructed an express locomotive (Fig. 62) to send to the Exhibition of 1862; it was in every respect similar to those previously constructed by the Caledonian Railway Company; it had double frames, outside cylinders, and a single pair of 8ft.-2in. wheels, and was, in fact, a larger edition of the Grand Junction Company's locomotives, as constructed at Crewe works in 1843 by Mr. Allan.

Diameter of cylinders	17½ ins.
Length of stroke	24 ins.
Diameter of driving-wheels	8 ft. 2 ins.
Total heating surface	1,172 sq. ft.
Weight on driving-wheels	14 tons 11 cwt.

This locomotive was purchased by the late Pacha of Egypt, who required an engine "to take him at an average speed of 70 miles an hour." This engine, by Neilson, also those built by Mr. Benjamin Connor, were

officially tested at 80 miles an hour, and some still remain in use on the Caledonian at the present time. They are good engines, but the existing loads and the Beattock incline have necessitated their removal from main line expresses.

Messrs. Stephenson & Co., in 1862, constructed a large passenger engine named "Saltburn" for the Stockton and Darlington Railway, having a leading bogie, four coupled wheels of 7 ft. diameter, the

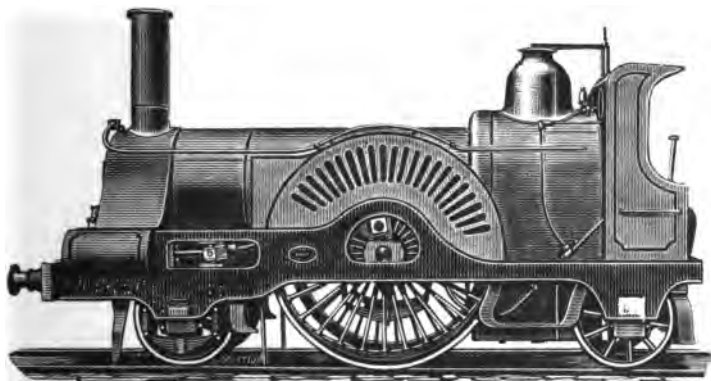

Fig. 62.—Express Engine, built by Neilson, 1862.

cylinders placed outside being 17×24 ; in this engine a small auxiliary tank was placed under the foot plate for heating the feed water by means of steam from the boiler.

About the year 1863 Mr. Sturrock introduced "steam tenders" upon the Great Northern Railway for the goods engines. These tenders had outside frames, six coupled wheels, and inside cylinders, steam being supplied from the engine boiler. The tender thus converted by Mr. Sturrock became practically a

second engine, having a water-tank in the place of a boiler. The cylinders were 12 inches diameter and 17 inches stroke, the cranked-axle being the middle one. The exhaust steam from the cylinders was discharged into a tubular condenser and heated the water in the tender tank. The weight of the tender empty was 18 tons, and loaded, 28 tons.

The steam tenders undoubtedly conveyed very heavy trains of coal, as the author saw when riding on one between Hitchin and London; and the Great Northern Company had about fifty in use, but they did not do the extra amount of work to pay for their cost, and practically they proved a great failure. Many of the tenders *without the steam apparatus* are still in use.

Mr. Matthew Kirtley, locomotive superintendent of the Midland Railway, in the early part of the year 1861 built several powerful tank engines to assist trains up the Lickey incline; these had double frames, six coupled wheels of 4 ft. diameter, and cylinders $16\frac{1}{2} \times 24$. They are still at work but renumbered.

Mr. Kirtley also, early in 1862, designed and constructed at Derby six powerful express engines to convey the anticipated heavy traffic to the exhibition of that year. These engines ran upon six wheels, the driving and trailing wheels being 6 feet 2 inches diameter, and coupled, the cylinders were $16\frac{1}{2}$ inches diameter, 24-inch stroke, and the steam pressure 140 lbs. per square inch; they were numbered 80 to 85 inclusive. On one occasion the writer rode from Leicester to King's Cross, London, upon one of these engines, when it drew 10 coaches, and on the return journey, with a much lighter load, a speed of 72 miles an hour was attained upon a falling gradient.

Previously to this date four-wheeled coupled engines

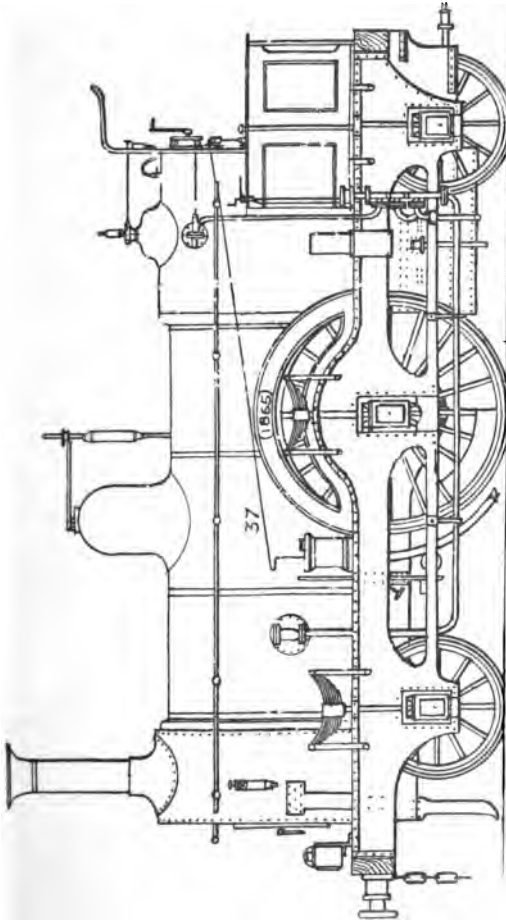

Fig. 63.—Kirtley's Express Engine, Midland Railway Company, 1864—5.

had been considered unsuitable for passenger traffic and high speed.

In 1864, Mr. Matthew Kirtley, the Midland Company's locomotive superintendent, decided to construct

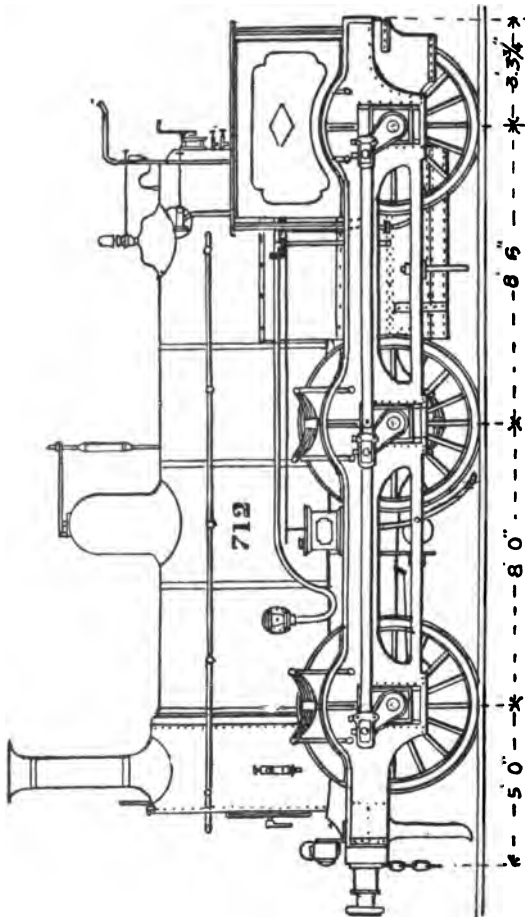

Fig. 64.—Kirtley's Goods Engine, Midland Railway Company, by Dübs & Co., 1869.

at the Derby Works 20 express engines, generally known as the "30 class," having cylinders $16\frac{1}{2} \times 22$,

and driving-wheels 6 feet 8 inches diameter (see Fig. 63).

These engines have been remarkable for the heavy work which they have performed, and for economy both in fuel and repairs.

With a load suitable to their power, they are still capable of running at the highest speeds, but of course they are not now sufficiently powerful for main line expresses.

From the formation of the Midland Railway Company in 1844 to the close of the year 1862, Mr. Kirt-



Fig. 65.—Tank Engine, No. 780, Midland Railway Company, 1870.

ley constructed the goods engines with cylinders 16 by 24, and 5 feet 2 inch wheels. From 1863 to 1869 he employed 16½ inch cylinders, and from 1869 to 1875, 17 inch cylinders (see Fig. 64).

For working the Midland Company's trains over the Metropolitan Railway, Mr. Kirtley designed, and Messrs. Dübs & Co. in 1870 constructed, twenty tank engines (Fig. 65) having cylinders 17 × 24, four coupled wheels 5 feet 2 inches diameter.

Mr. Kirtley also designed a powerful class of express

engine for the Midland Railway, of which forty-eight were built in 1870, thirty by Messrs. Neilson & Co., and eighteen at Derby, having cylinders 17×24 , and four coupled wheels of 6 feet 8 inches diameter; the tractive force which could be exerted for each pound of effective steam pressure per square inch upon the pistons being 86.7 lbs., or thus—

$$\frac{17 \times 17 \times 24}{80} = 86.7 \text{ lbs.}$$

The distance between the centres of the two cylinders is 2 feet 6 inches; this has always been a very great advantage to these engines, on account of the extra width available for steam and exhaust passages.

The boiler and fire-box were of the standard pattern, previously used by Mr. Kirtley for his goods engines (Fig. 64). The boiler contained 168 brass tubes of 2 in. diameter outside, and was fed by one injector and one pump.

							sq. ft.
Heating surface of tubes	993
Heating surface of fire-box	103
							<hr/>
Total	1096

Two safety valves were placed upon the dome, pressed to blow off at 140 pounds per square inch.

A Roscoe lubricator was also provided.

Surface or area of fire-grate, 17 square feet; wheel-base of engine, 16 feet 6 inches.

Weight in working order—

							tons	cwt.	qrs.
Of engine	35	18	2
Of tender	24	15	2
							<hr/>		
Total	60	14	0

These engines have been remarkable for their excel-

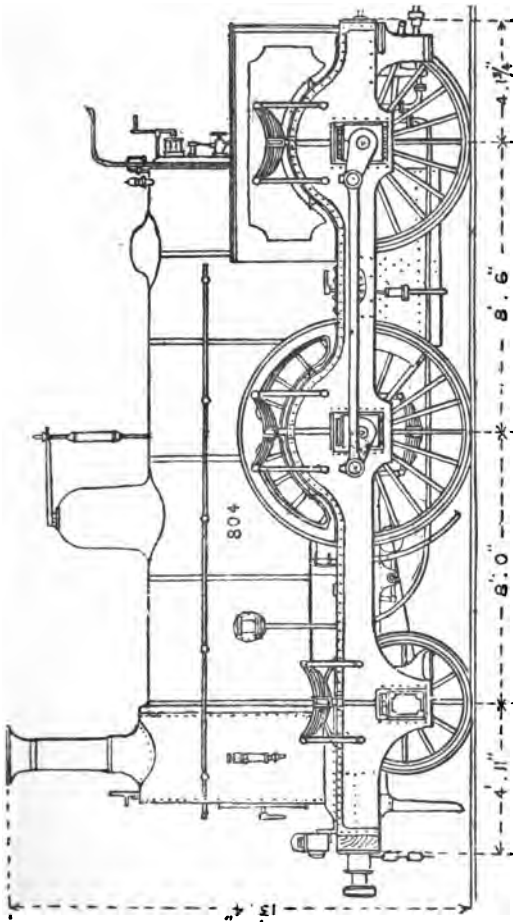

Fig. 66.--Midland Express Engine, "800 Class," 1870.

lent working, and since their cylinders have been en-

Diameter of coupled wheels	ft.	in.
Number of tubes	232	
Diameter of tubes	0	1½
Boiler pressure	140 lbs. per square inch.	
Heating surface of fire-box	sq. ft. 92	
Heating surface of tubes	1,020	
Total	1,112	
Number of square inches of bearing surface on each pair of journals	} Leading Driving Trailing	104·
		133·
		129·
Weight of engine in average working order ..	tons cwt. 36 14	
" tender	26 4	
Total	62 18	

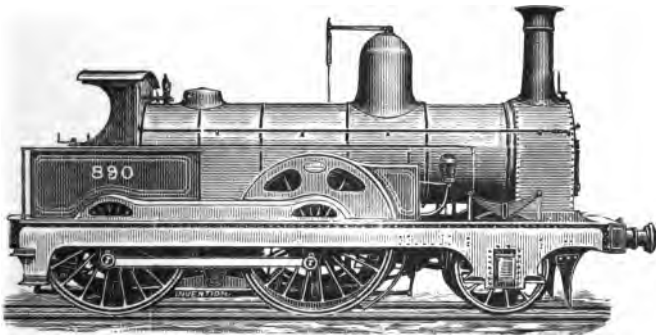

Fig. 68.—Kirtley's Express Engine, Midland Railway Company, 1871.

When the American Pullman car trains were first introduced into this country in 1874 engines of the 890 class were employed to work them, and were specially fitted with a central buffer at the back of the tender, as the cars had not side buffers.

CHAPTER IV.

MODERN LOCOMOTIVES FOR MAIN LINE TRAINS.

It being difficult to exactly define what is meant by "modern locomotives," for the purposes of this chapter engines will be included which have been designed and constructed within the past twenty years.

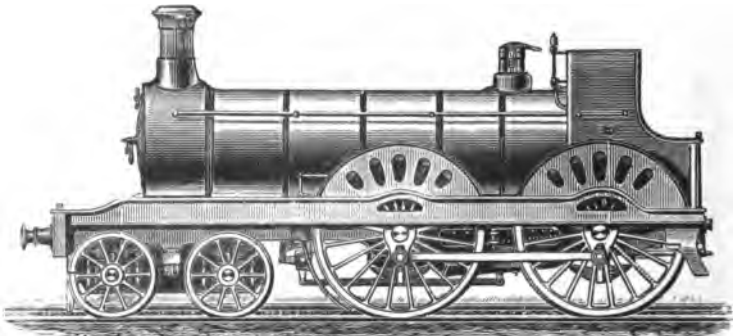

Fig. 69.—Glasgow and South-Western Express Engine, July, 1873.

Mr. James Stirling, locomotive superintendent of the Glasgow and South-Western Railway, at Kilmarnock, in 1873, was the first locomotive engineer to introduce a design or combination which included a leading-bogie, four coupled wheels 7 feet diameter, and inside cylinders 18 inches diameter.

The tractive force exerted for each pound of effective steam pressure per square inch in the cylinders being, therefore,—

$$\frac{18 \times 18 \times 26}{84} = 100.285.$$

It had been contended by many engineers that a pair of 18-inch cylinders with their valves between them could not be placed between the frames of an engine upon the 4 feet 8½ inch gauge, but Mr. Stirling proved that sufficient space existed by placing the cylinders thus in his new engine.

The boiler is flush-topped, having a Ramsbottom safety-valve placed over the fire-box casing, and is without a dome.

No. 6 (Fig. 69) was reversed by means of screw gear, but in May, 1874, Mr. Stirling completed a similar locomotive, No. 95, and it was the first to be fitted with his steam reversing gear. This gear consists of two small cylinders placed horizontally upon the right-hand side of the foot-plate, both the pistons being attached to one rod which passes out through the front cylinder cover and is connected to the rod working to the reversing gear. By means of a small handle the engine-driver can admit steam to either end of the steam cylinder, and thus put the engine in forward or backward gear at pleasure. Between the two cylinders the piston rod carries an index which works over a fixed scale showing the position of the gear and the proportion of the stroke at which the steam is being cut off in the main locomotive cylinders.

To retain the steam reversing gear in any required position the second small cylinder is completely filled

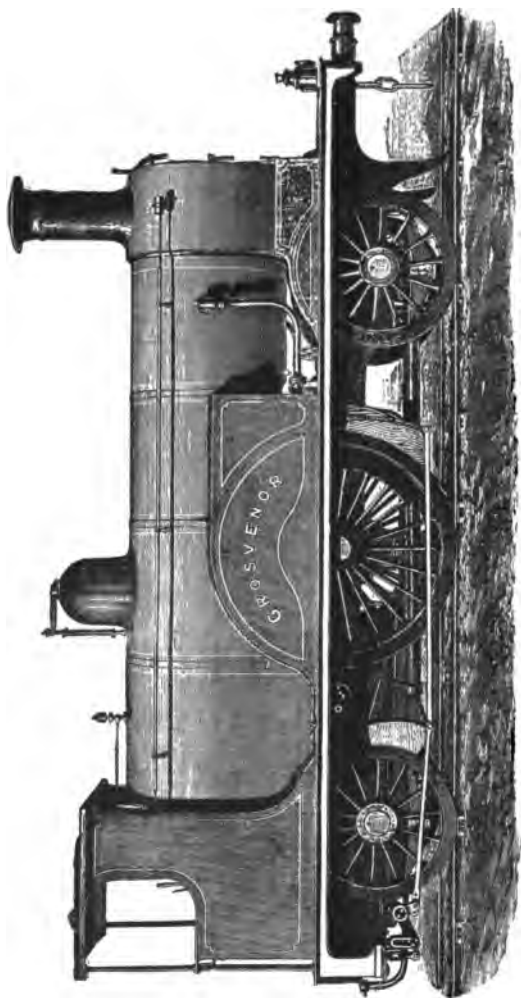

Fig. 70.—Brighton Company's Express Engine, 1874.

with oil, and its piston can only move when the driver permits a valve to open to allow the oil to pass from one end of the small cylinder to the other.

Therefore, without any manual labour the engineman can reverse the locomotive by means of a small handle upon the foot-plate, and as the one handle actuates both the steam valve and the oil valve, it follows that in whatever position the driver stops the supply of steam the oil will firmly hold the gear.

Engines of this type still remain the standard pattern upon the Glasgow and South-Western Railway, and Mr. Stirling has during recent years introduced a very similar design upon the South-Eastern Railway, but having cylinders 19 inches diameter, for working the express trains between Charing Cross and Dover.

In 1874 Mr. Stroudley designed and constructed at the Brighton Works an engine named the "Grosvenor," No. 151 (Fig. 70).

This engine has a single pair of driving-wheels 6 feet 9 inches diameter, cylinders 17 × 24, weight on driving-wheels 14 tons. The "Grosvenor" was sent with the Brighton Company's train to the Newark Brake trials in 1875; it also was the engine employed throughout Captain Galton's brake experiments in 1878—79.

When the "Grosvenor" was new the author rode several trips upon her foot-plate. On one of these 22 coaches were conveyed from London to Brighton by the five o'clock express without any loss of time.

Mr. S. W. Johnson, in 1875, introduced a powerful type of engine upon the Midland Railway for the conveyance of heavy mineral trains, No. 1148 (Fig. 71), being one of those built by Kitson & Co.

Engines of this class have cylinders $17\frac{1}{2} \times 26$, and

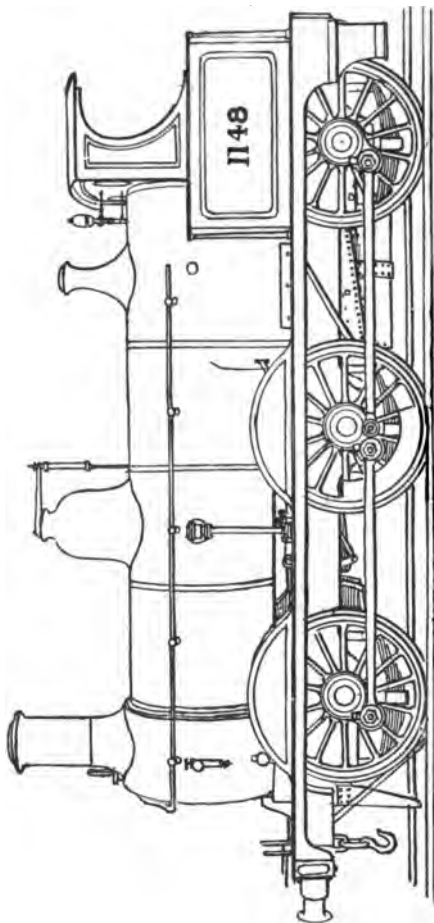

Fig. 71.—Midland Mineral Engine, 1875.

six coupled wheels of 4 feet 10 inches diameter; the

tractive force for each pound of effective pressure on the pistons being therefore—

$$\frac{17\frac{1}{2} \times 17\frac{1}{2} \times 26}{58} = 137.284.$$

Heating surface 1,225 square feet.

In 1878 Mr. F. W. Webb, of the London and North-Western Railway, converted one of the old engines on that line into a compound, on Mr. Mallet's system, the result of its working being that Mr. Webb in 1881-2 built at Crewe a compound engine of his own design named "Experiment," No. 66.

Mr. Webb's system employs three cylinders, namely two high-pressure cylinders of equal size, placed outside and arranged to drive the hind driving-axle, and one low-pressure cylinder placed inside, under the smoke-box, and arranged to drive the front driving-axle; the steam, of course, passing from the two high-pressure cylinders into the one low-pressure cylinder.

There is no subject relating to locomotive construction which has engaged so much attention and caused so much controversy as the introduction of "Compound" Express Engines. The advocates of the compound principle maintain that "as the steam is used twice over there must be a saving in fuel, and that even if some of the early engines built are not fully up to expectations the defects will be overcome in the next to be constructed."

On the other hand the advocates of the "Simple" system point out that two sets of cylinders and motion are cheaper to construct and cheaper to maintain than three sets; they hold the opinion that there is no

saving in coal, and that even if there were, it would be due to the high pressure of steam used, not to the compound principle; and with regard to the question of fast running they refer to the fact that at the time of the great railway race of 1888 the three-cylinder engines had to be withdrawn, and "simple two-cylinder" engines employed to perform the fast running.

The only possible way to prove what are the real capabilities of the "Simple" and "Compound" systems, respectively, is to have a complete and impartial trial. Let two engines be built, the one "Simple," the other "Compound"—the boilers, fire-boxes, heating surface, pressure of steam, and diameter of driving-wheels, being identical in each. Let the first cost, cost of maintenance, consumption of coal and oil, be carefully ascertained, and let the two engines be run over the same section of line with similar trains; in fact, have the trials made absolutely fair, and in a very short time the results would settle all the controversy.

The writer has watched the subject most carefully from the first, in an impartial spirit, but he cannot fail to observe that "facts" are in favour of the "Simple" engine. Whatever a "Compound" engine can do a "Simple" engine can do, and frequently with more efficiency. It is therefore not a matter of surprise that the locomotive superintendents of all the other important lines, after having made themselves fully acquainted with the "Compounds" in use in this country, continue to build large numbers of non-compound express engines, which give great satisfaction.

In 1881 the late Mr. William Stroudley, locomotive superintendent of the London, Brighton and South

Coast Railway, found that engines of increased power were required to work the Company's express trains, which were constantly increasing in weight; for instance, the 8.45 A.M. express from Brighton to London Bridge being a train often consisting of 25 coaches, the time allowed being 1 hour 10 minutes, the weight, including engine and tender, being fully 350 tons. The return train leaves London Bridge at 5 P.M., and arrives at Brighton at 6.5 P.M.

Mr. Stroudley, therefore, constructed in 1882, at the Brighton works, a powerful express engine named "Gladstone" (Fig. 72).

Diameter of cylinders ($18\frac{1}{2}$)	ft.	in.
Length of stroke (26)	1	$6\frac{1}{2}$
Diameter of coupled wheels	6	6

The tractive force for each pound of effective pressure in the cylinders is therefore—

$$\frac{18\frac{1}{2} \times 18\frac{1}{2} \times 26}{78} = 111.020 \text{ lbs.}$$

Total heating surface	1,485 sq. ft.
Weight of engine in working order	38 tons. 14 cwt.
Tender loaded	27 7
Total	66 1

This engine is fitted with the Westinghouse automatic brake applying two cast-iron blocks to each of the coupled wheels, and one block to each tender wheel. The valves are actuated by the ordinary "Howe" curved link motion, the reversing being performed by the late Mr. Stroudley's arrangement, in which air from the Westinghouse brake is made to do the duty of a reversing lever or screw.

The position of the valves is under the cylinders,

therefore it follows that when steam is shut off, all friction between valves and their faces ceases. To reduce the wear of the leading wheels Mr. Stroudley arranged a pipe leading from the bottom of the exhaust, in order to turn a jet of steam against the flange of each leading wheel, the cold wheel condenses the steam and lubricates the flanges, and when running round sharp curves, especially in dry weather, the grinding noise of leading wheels, so often observed upon many lines, is consequently avoided.

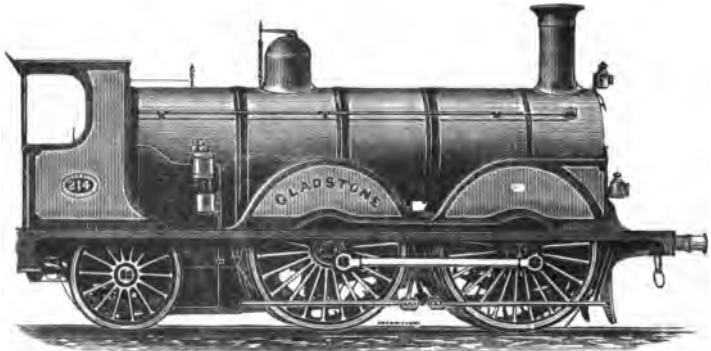

Fig. 72.—Brighton Company's Express Engine, 1882.

The tender runs upon six wheels, carries 2,250 gallons of water and two tons of coal, and has inside frame and inside bearings only.

A number of other similar engines have been built, one of which, named "Edward Blount," obtained a gold medal at the Paris Exhibition in 1889.

Engines of the "Gladstone" type have very successfully coped with the difficulty of conveying express trains of excessive length; however, in consequence of the increase of traffic and the generally-expressed wish of the passengers that "the journey from London to

Brighton should be performed in an hour," it is probable that at no distant date some of the heaviest trains will have to be run in duplicate.

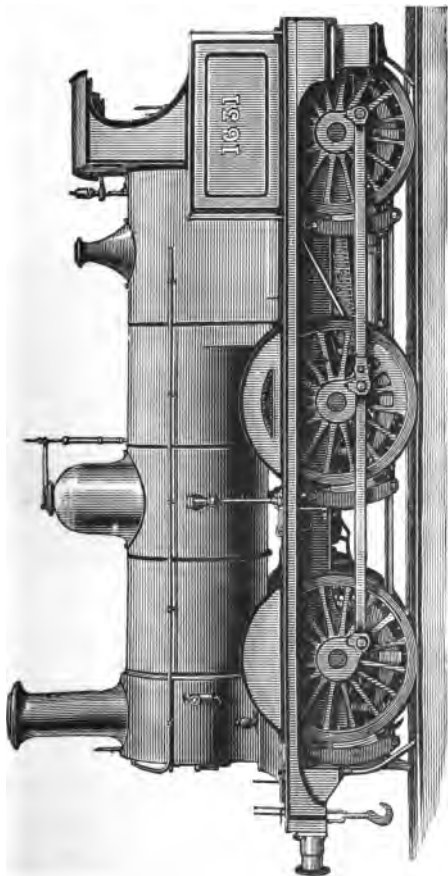

Fig. 73.—Midland Goods Engine, No. 1631.

The line from London Bridge to Brighton is about $50\frac{1}{2}$ miles in length, and about three miles from London the New Cross incline of 1 in 100 for $2\frac{1}{2}$ miles com-

mences, after which the line rises and falls by gradients of 1 in 264 to three summits, one at Merstham tunnel, another at Balcombe tunnel, and the third at the Clayton tunnel. It therefore follows that with a train of fair average length, an engine having a "single" pair of driving wheels of 7 feet or 7 feet 6 inches diameter could, without difficulty, perform the journey of $50\frac{1}{2}$ miles in 60 minutes.

Fig. 72 shows that the "Gladstone" has the four large coupled wheels placed in front; this arrangement enables a very much shorter coupling-rod to be em-

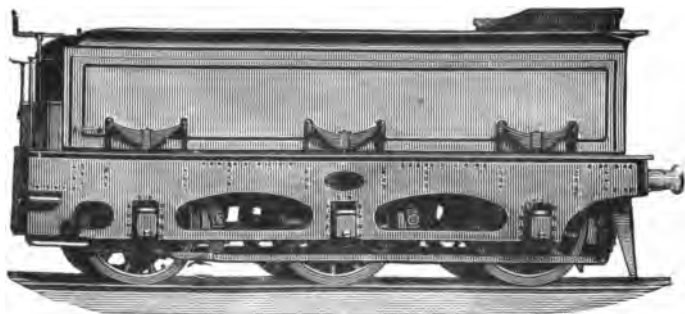

Fig. 74.—Midland Tender, No. 1631.

ployed, and leaves the length of the fire-box practically unlimited, which is not the case when the trailing wheels are coupled. However, for the fastest express work the writer would prefer an uncoupled wheel as leader.

The heavy express goods traffic upon the Midland Railway necessitates the employment of powerful locomotives. In 1877, Mr. Johnson introduced engines for this work having cylinders $17\frac{1}{2}$ by 26 inches, and wheels of 5 feet $2\frac{1}{2}$ inches diameter; his more recent

engines are of similar appearance, but have cylinders 18 by 26 inches, wheels 5 feet 2½ inches and a boiler pressure of 150 lbs. per square inch. Several hundreds of these engines are at work and giving good results.

The tender (Fig. 74) runs on six wheels, carries 2,200 gallons of water, and has a coal space of 144 cubic feet.

Mr. S. W. Johnson, the locomotive superintendent of the Midland Railway, introduced "bogie" express engines upon that line in 1876, and since that time 190 have been built of the same general design as Fig. 75, but with cylinders varying from 17½ to 19 inches diameter. Until 1885, the steam pressure employed was 140 lbs. per square inch, but in that year Mr. Johnson designed the 1738 to 1757 class, having steel boilers and a high pressure of 160 lbs. per square inch. Their dimensions being—

Diameter of cylinders	(18)	1	6
Length of stroke	(26)	2	2
Diameter of coupled wheels		7	0

The tractive force exerted for each pound of effective steam pressure per square inch in the cylinders being, therefore, thus—

$$\frac{18 \times 18 \times 26}{84} = 100.285.$$

As the steam pressure carried is 160 pounds per square inch, and the weight available for adhesion is over 28 tons, it follows that the engine is capable of performing fast and very heavy work.

Distance apart of cylinders from centre to centre		2	4
Length of boiler between tube plates		10	10 ⁹ / ₁₆
Mean diameter of boiler inside		4	1
Number of tubes	246		
Diameter of tubes		0	1½

Pressure of steam	160 lbs.
Total heating surface	1,261 sq. ft.

Weight in working order—

	tons.	cwts.	qrs.
On bogie wheels	14	12	1
On driving wheels	15	0	0
On trailing wheels	13	2	2
Total	42	14	3

Weight of tender, full, 3,250 gallons of water and 2 tons of coal	36	1	1
--	----	---	---

Grand total engine and tender	78	16	0
-------------------------------	----	----	---

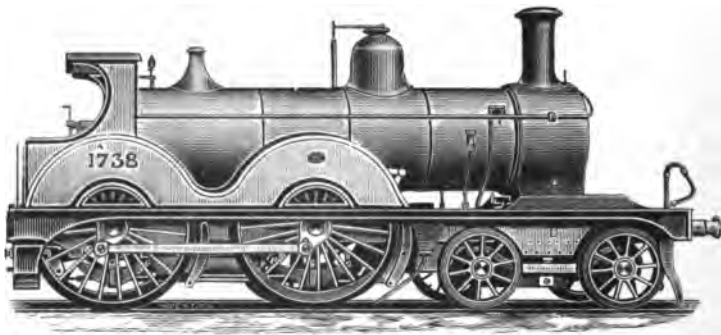

Fig. 75.—Midland Railway Express Engine, built 1885.

One of these engines, No. 1757, "Beatrice," was sent in 1887 to the Saltaire Exhibition, and has since been employed to work several royal trains.

For the purpose of working the Midland Company's trains over the Lancashire and Yorkshire Railway, *viâ* Hellifield, and thence to Carlisle, Mr. Johnson in 1888 designed the 1808 to 1822 class, similar to No. 1738, but with coupled wheels of only 6 feet 6 inches diameter.

The following was the complete list of the Midland Company's coupled bogie express engines to 1895 :—

Nos.	Builder.	Date.	Cylinder.	Stroke.	Coupled wheels.		Pressure of Steam.
			In.	In.	Ft.	In.	
1312 to 1321	Kitson	{ 1876 } { 1877 }	17½	26	6	6	140
1327 to 1346	Dubs	1877	18	26	7	0	140
1562 to 1581	M.R. Co.	{ 1882 } { 1883 }	18	26	6	9	140
1657 to 1666	M.R. Co.	1883	18	26	6	9	140
1667 to 1676	M.R. Co.	1884	19	26	7	0	140
1738 to 1757	M.R. Co.	{ 1885 } { 1886 } { 1887 }	18	26	7	0	160
1808 to 1822	M.R. Co.	1888	18	26	6	6	160
11 and 14 } 80 to 87 }	M.R. Co.	1891	18	26	6	6	160
2183 to 2202	Sharp Stewart }	1892	18½	26	7	0	160
2203 to 2217	Sharp Stewart }	1893	18½	26	6	6	160
184 to 199 } 161 to 164 }	M.R. Co.	1894	18½	26	6	6	160
230 to 239	M.R. Co.	1895	18½	26	6	6	160

The Caledonian Company's express engine No. 123 (Fig. 76), was constructed by Neilson & Co., and attracted much attention at the Edinburgh Exhibition, 1886, and during the "railway race," 1888.

The following are the principal dimensions :—

Diameter of driving-wheels	7 feet.
Diameter of cylinders	18 inches.
Length of stroke	26 inches.

The tractive force exerted for each pound of effective pressure per square inch in the cylinders being thus :—

$$\frac{18 \times 18 \times 26}{84} = 100.285 \text{ lbs.}$$

Working pressure of steam 150 lbs.
 Weight on driving wheels 17 tons.

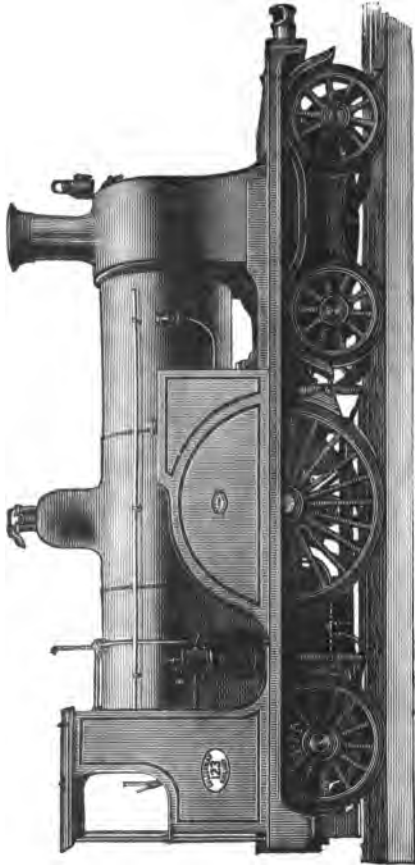

Fig. 76.—Caledonian Express Engine, No. 123, 1886.

		tons	cwts.
Weight of engine in working order	41	18
Tender loaded	33	9
		<hr/>	
Total	75	7

The engine is provided with Adams' vortex blast-pipe, the Westinghouse automatic brake, a sand-blast, two injectors, and two water gauges.

No. 123, during the "railway race," worked the West Coast trains between Carlisle and Edinburgh.

The writer rode several trips in trains over this distance, and on one day timed the 101 miles covered in 104 minutes, some of the rising gradients being very severe, namely 1 in 75 on Beattock incline.

Number 123 was put into express traffic between Edinburgh and Carlisle on June 1, 1888.

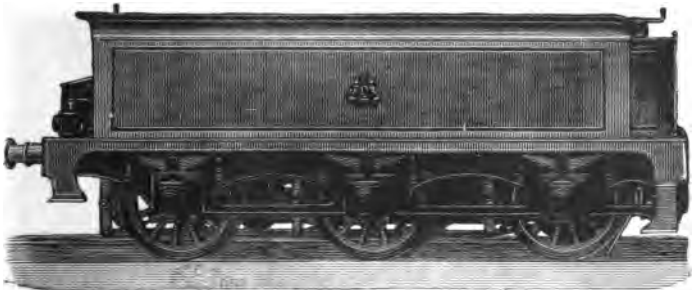

Fig. 77.—Caledonian Tender, No. 123.

The average number of vehicles was seven, six of which were 8-wheeled carriages, each 42 feet long, and one a 6-wheeled brake van, giving a total train weight of about 146 tons, exclusive of engine and tender.

The average consumption of coal during the "racing" months of August, September and October, 1888, was 31.8 lbs. per engine mile.

The tender (Fig. 77) runs on 6 wheels, and carries 2,850 gallons of water, and has a coal space of 210

cubic feet. The tender brake can be applied by either Westinghouse apparatus or by the usual hand-screw. Wheel-base of engine and tender, 42 ft. 6 in.

Mr. Patrick Stirling, late locomotive superintendent Great Northern Railway, having employed express engines with cylinders 17 by 24 inches, and a single pair of 7 feet wheels, decided to design a much more powerful type of express engine, having a larger driving-wheel and larger cylinders; and, as he could not employ inside cylinders, in consequence of the

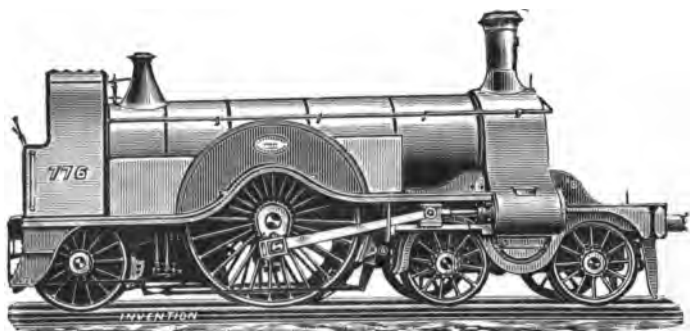

Fig. 78.—Type of Great Northern Express Engine, 1870 to 1895.

height of the cranks, he placed them outside, where he could get them between the wheels of the bogie, and in a horizontal line with the centre of the driving-wheel. The first of these was built in 1870, and 53 of this pattern (Fig. 78) are now at work.

The particular engine illustrated was the "Jubilee" engine sent to the Newcastle Exhibition, 1887.

	ft.	ins.
Diameter of cylinders	0	18
Length of stroke	0	28
Diameter of driving-wheels (nominal)	8	0

Therefore the tractive force exerted for each pound of effective steam pressure per inch in the cylinder is thus—

$$\frac{18 \times 18 \times 28}{96} = 94.5 \text{ lbs.}$$

Total heating surface 1,045 sq. ft.

Weight of engine in working order—

					tons.	cwts.
On front bogie wheels	8	2
On rear bogie wheels	9	9
On driving wheels	17	0
On trailing wheels	10	12
					<hr/>	
				Total ..	45	3
Weight of tender loaded	33	7
					<hr/>	
Grand total, engine and tender			78	10

At the time of the “race,” engines of this type with loads of 7 to 9 coaches, weighing 120 to 140 tons, burnt only 22.6 lbs. of coal per mile, when working between London and Grantham, and Grantham and York. Nothing can more clearly show their economy in regard to fuel.

The line rises upon leaving London, King’s Cross, by gradients of 1 in 105 and 1 in 110 through Maiden Lane and Copenhagen tunnels, and from about the 4½ mile post to the 12¾ post is all rising one in 200. It is found in practice that engines similar to Fig. 78 can take from 16 to 20 coaches up hill to Potter’s Bar at an average speed of 40 miles an hour, and then they can run the remaining 92 miles to Grantham without a stop at an average of just under, or if necessary, fully 60 miles an hour. In 1888 No. 776 took an important part in the “race to Edinburgh,” and

engines of this type have been timed at a speed of "just under, or practically, 80 miles an hour."

Since 1886 Mr. Stirling has placed several new express engines upon the Great Northern Railway, known as the 230 class, in which he has returned to the inside cylinder pattern. These have 6 wheels, cylinders $18\frac{1}{2} \times 26$, and driving wheels 7 feet $7\frac{1}{2}$ inches when new.

The practical result of working is that both types are very efficient. The inside cylinder class is less costly to build, the coal consumption is the same in both; and with reference to the question of speed it is found that the 7 feet 6 inch engines can run equally as fast as the 8 feet engines. For extremely fast running an *inside* cylinder engine is more suitable than an *outside*; it is therefore probable that in future the inside cylinder class will become the standard.

A special series of comparative trips recently made between Doncaster, York, and Peterborough, with a "compound" engine, and a Great Northern "simple" engine resulted considerably in favour of the latter.

For working the Great Eastern Company's heavy express trains between London, Yarmouth, Cromer, Doncaster, &c., Mr. James Holden has designed and constructed at Stratford several engines of the type illustrated (Fig. 79).

These engines have four wheels coupled, 7 feet diameter, the leading end being carried by a pair of 4 feet wheels.

The cylinders are 18 inches diameter, and the stroke 24 inches; the tractive force exerted for each pound of effective steam pressure per square inch on the pistons is therefore—

$$\frac{18 \times 18 \times 24}{84} = 92.57.$$

The axle of the leading wheels is provided with both inside and outside axle-boxes.

Total heating surface	1,230 sq. ft.
Weight in working order	42 tons
Weight of tender	30 tons 12 cwts.
	<hr/>
	72 tons 12 cwts.

The boiler is 4 feet 3 inches diameter inside, butt jointed, the plates being of steel $\frac{1}{2}$ inch thick, and the working pressure of steam 150 lb. per square inch.



Fig. 79.—Great Eastern Express Engine, No. 719.

The inside fire-box is of copper $\frac{1}{2}$ inch thick, except the tube plate, which is 1 inch thick at top and $\frac{1}{2}$ inch at the bottom. It is now the practice at Stratford to fit all engines having cylinders 17 inches diameter and upwards with $5\frac{1}{2}$ inches steam pipes and large regulators.

Indicator diagrams taken from the steam chest and cylinders show far less wire drawing at high speeds than formerly with the $4\frac{1}{2}$ -inch pipes.

The cylinders are cast in one, and placed with the

valve faces downwards. This arrangement allows of long axle bearings. The cylinders are well drained, and the valves can drop from the faces when running with steam shut off.

The valves are worked by the ordinary link-motion, counterbalanced by a spring and reversed by a wheel and screw. All engines now built at Stratford have single slide-bars, and cast-steel cross-heads, motion plates, spring hanger brackets, spring hangers, horn blocks, etc., and cast steel is now being introduced for all wheels. The coupling rods are made of wrought-iron of I section.

The tender is carried upon six cast-steel wheels of 4 feet diameter, the springs being outside the frames and (like all the new tenders) is now fitted with axle-boxes of a new pattern; the box is cast in one without keep, a large oil reservoir is arranged to slip in under the journal from the front, which is easily removed to change the oil pads as required; a dust shield is provided at the back or inner end of the box. These axle-boxes are found to work very satisfactorily, and there has not been any case of trouble from their heating. The tender carries 2,640 gallons of water and three tons of coal.

The whole of the passenger rolling stock upon the Great Eastern Railway, including, of course, engine 719, is fitted with the Westinghouse automatic continuous brake.

The express trains upon the Great Eastern Railway are heavy, more especially so during the summer months, when they are made up at Liverpool Street Station from 18 to 21, and sometimes even more, 6-wheeled carriages, the majority of which are third-

class six compartment vehicles, all fully loaded and drawn by one engine. The work which has to be performed by such engines is very greatly increased, as the writer observed when travelling with the trains, by the fact that at a distance of about half a mile from the starting point the Bethnal Green incline commences and continues for nearly three-quarters of a mile upon a gradient of 1 in 70; the gradients on both the company's main lines are severe, the curves both numerous and sharp, and the trains long.

In 1888 Mr. Holden designed a new type of express engines somewhat similar in appearance to 719, but having a "single" pair of 7 feet driving-wheels; these are also giving great satisfaction.

The Great Eastern Company has several locomotives at work fitted with Mr. Holden's system for burning liquid fuel. One of these, "Petrolea" (No. 760), is fitted to burn liquid fuel, but beyond the addition of an oil tank on the tender, and a few pipes leading to the liquid fuel injectors below the fire-hole door, there is nothing in its outward appearance to distinguish it from a coal-burning locomotive, to which it can be converted at any moment, there being no alteration in the construction of the fire-box. A special feature of the injector is an outer ring through which jets of steam pass, these jets impinging at the nozzle on the liquid fuel induced through a central cone, and breaking the fuel up into a very finely divided spray which ignites immediately. There is a passage in the injector through which air also is induced, and as the emission of steam, liquid, and air can be adjusted independently of each other, combustion is regulated to a nicety, and the slightest smoke

avoided. The fire is lit up with coal in the usual way, and a bed of incandescent fuel and chalk or broken bricks kept up, the weight of coal used in conjunction with the liquid fuel being about one-third of the total fuel consumed. The saving of labour to the fireman is, of course, very great, whilst the incandescent base enables the engine to lie practically inert for hours if required, yet ready to start into action directly the injector is worked. The "Petrolea" is employed to work some of the fastest and most important of the Company's trains, and the "fuel experiment" is being watched with great interest.

The Manchester, Sheffield, and Lincolnshire Company has recently constructed a new class of engine (Fig. 80), at its Gorton works, from the designs of Mr. Parker, locomotive superintendent.

These engines work the main line trains between Manchester, Retford, and Grantham. They have cylinders 18 × 26, coupled wheels 6 ft. 9 in. diameter, with pressure of steam 160 pounds. Total heating-surface, 1,278 square feet. The tractive force for each pound of effective pressure is 104 lbs. The piston speed when running at 60 miles an hour is thus—

$$\frac{26 \times 60 \times 56}{81} = 1,076 \text{ feet per minute.}$$

Weight of engine in working order	46 tons.
Tender in working order	35 tons.
Total	<u>81 tons.</u>

The tender carries 3,080 gallons of water and 4 tons of coal, and is provided with a special design of axle-box which is easily accessible.

The main line of the Manchester, Sheffield, and Lincolnshire Company forms a very considerable link in the through route between Manchester (London Road) and London (King's Cross); and to avoid an extra stop at Retford, the Sheffield Company's engines work these express trains over the Great Northern Railway as far south as Grantham, and it is upon this important service that No. 564 and its sister engines are employed.

The loads vary from 120 to 200 tons, equivalent to

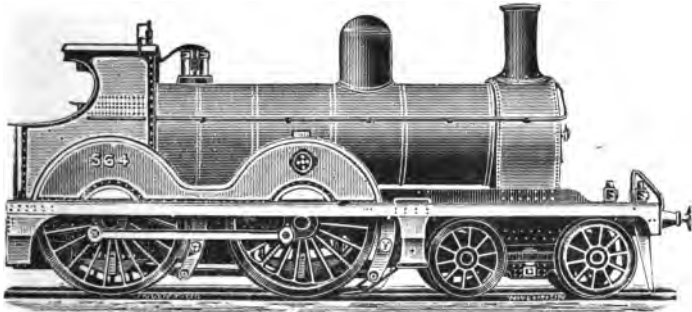

Fig. 80.—M. S. & L. Express Engine, 1887.

nine to fifteen vehicles. The average speed, exclusive of stoppages, equals $44\frac{1}{2}$ miles an hour.

In order to fully appreciate the work which has to be performed, it is necessary to take into account the heavy gradients and also the very numerous curves which exist (the sharpest of which has a 7-chain radius), and which, of course, cause much extra flange friction. The writer has recently made several trips in trains over the route in order to carefully note the actual working of the engines upon the various gradients.

Leaving Manchester, the engine has one continuous up-hill pull of 22 miles to Dunford Bridge, the gradients being chiefly 1 in 100, 108, 97, 100, 177, 201.

Upon the return journey, after leaving Sheffield, the train has to climb up to Dunford Bridge, 19 miles of 1 in 132, 120, 131, 100, 135. Railway-men will see at a glance the work which these gradients imply, more especially when the long incline has to be faced after the engine has worked from Grantham to Sheffield, a distance of 56 miles, and made a start from that station.

The average consumption of coal per mile of the 564 type has been reduced to 24 lbs., and under favourable circumstances to $22\frac{1}{2}$ lbs., per mile.

At the present time the Manchester, Sheffield, and Lincolnshire line may be regarded as an extensive local system, its engines working from Liverpool on the west to Grimsby on the east, north to Leeds, and south to Grantham. By a recent Act of Parliament, the company's system is now extended to Nottingham, and by means of the new line through Leicester to Aylesbury it is now certain that at no distant date the Manchester, Sheffield, and Lincolnshire line will, in connection with the Metropolitan, become a great through route upon which its own engines will work trains to London.

The North Eastern Company exercises its running powers over the North British Railway between Berwick and Edinburgh, and provides the locomotive power for the through East Coast Joint Stock expresses between York and Edinburgh. For several years this service was worked by engines designed by Mr. Fletcher in 1870, having four coupled 7 feet

wheels and cylinders 17 by 24. In 1885 twenty express engines were built at the suggestion of Mr. Tennant, General Manager; these had 4 coupled 7-foot wheels, cylinders 18 by 24, and 1,250 square feet of heating surface; these proved remarkably fine engines, and still work the express trains between Newcastle and York.

In the early part of the year 1889 Mr. T. W. Worsdell, having become the Company's locomotive superintendent, made a new departure by constructing an engine—No. 1329—having a single pair of driving wheels 7 feet $1\frac{1}{2}$ inches diameter, and upon the compound principle. The working results of this engine proved thoroughly satisfactory to Mr. Worsdell; he therefore decided to construct five others of a still larger design, one of these being No. 1518 (Fig. 81).

Mr. T. W. Worsdell has laboured very energetically in the development of the "two-cylinder compound engine" (Fig. 81), which he maintains is better than the three-cylinder system.

The North-Eastern compound engines are worked upon the system of Messrs. Worsdell and Von Borries; the latest design (Fig. 81) has a high-pressure cylinder 20 inches diameter, and a low-pressure cylinder 28 inches diameter, the stroke in both cases being 24 inches. To place two such large cylinders between the frames it was found necessary to fix them at different levels, so that their axes are not parallel.

The driving-wheels are 7 feet $7\frac{1}{4}$ inches diameter.

The valves are worked by the Joy gear, through the medium of rocking shafts. There is also a special valve arrangement by which high-pressure steam can be admitted direct to the low-pressure cylinder. This

arrangement enables the engine to be started when the high-pressure cylinder is upon a dead point. The boilers have been built to carry a working pressure of steam of 200 pounds per square inch, but at the present time 175 pounds is the pressure used.



Fig. 81.—North Eastern Compound Engine, 1889.

Total heating surface....	1,139 sq. ft.
Weight on driving wheels	17 tons, 15 cwt.
Weight of engine (full)	46 tons. 13 cwt. 2 qrs.
Weight of tender (full)	40 tons. 1 cwt. 0 qrs.
Total	86 tons. 14 cwt. 2 qrs.

The weight of 17 tons 15 cwts. upon the driving-wheels, assisted by the sand-blast, is found amply sufficient to provide the necessary adhesion.

This is the heaviest class of engine and tender complete running in this country.

The tender carries 4 tons of coal and 3,940 gallons of water, which enables these engines to run through from Newcastle to Edinburgh, 124 miles 31 chains, without a stop.

Several of these engines have run at very high speed,

and the writer has timed them at just under 80 miles an hour.

No. 1,517 was put into traffic between Newcastle and Edinburgh early in October, 1889. The loads varied from ten to twenty-two vehicles. At the end of October the average coal consumption was stated to be 26·4 lbs. per mile. On one occasion a trial was made between Newcastle and Berwick with a train of thirty-two empty carriages; the distance—67 miles—was run in 78 minutes, or three minutes under the time of the Scotch Express, and this with a load of certainly not less than 270 tons, exclusive of engine and tender.

Mr. Worsdell has also conferred a boon upon the drivers and firemen of the North-Eastern Railway, by providing them with a good comfortable cab, as shown (Fig. 81).

A similar engine, No. 1,521, was sent to the Edinburgh Exhibition of 1890.

Mr. William Adams, when locomotive superintendent of the London and South-Western Railway, designed and constructed, at Nine Elms, twenty express engines (Fig. 82) of great size and power.

Diameter of cylinders	19 ins.
Length of stroke	26 ins.
The piston-rod passes through the front cover of the cylinder.	
Diameter of bogie wheels	ft. ins. 3 9½
Diameter of coupled wheels	7 1
Length of boiler barrel	11 0
Length between tube-plates	11 4
Diameter of boiler outside	4 4
Number of tubes	240
Diameter of tubes outside	0 1½
The boiler is made of mild steel plates. Working pressure of steam, 175 lb. per sq. in.	
The boiler is fed by two No. 8 injectors.	
From rails to centre of boiler	7 8

Heating surface of tubes	1,245·60	sq. ft.
Heating surface of fire-box	122·16	„
	<hr/>	
Total	1,367·76	„
Area of fire-grate	18	„
		ft ins.
From front of buffer plate to centre of bogie ..	8	4 $\frac{1}{2}$
From bogie centre to centre of driving-axle	10	9
From driving to trailing	8	6
From trailing axle to back of frame	4	3

The frames are of mild steel, placed inside, and the axles have inside-bearings only; the driving and trailing springs are attached to a compensating beam;

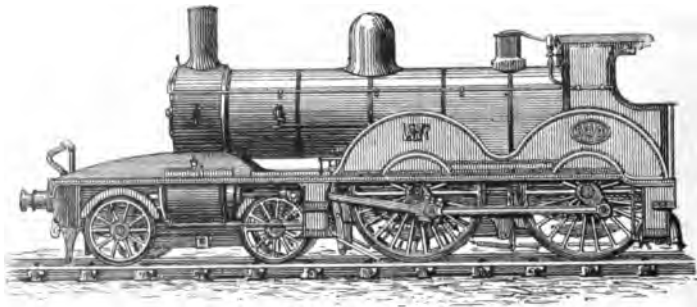

Fig. 82.—London and South-Western Express Engine,
No. 580.

the axles are of cast-steel; the tires of steel; copper fire-box and brass tubes; the coupling-rods are of wrought-iron of I. section.

The tender runs on six wheels of 3 ft. 9 $\frac{1}{4}$ ins. diameter, the capacity of the tank being 3,300 gallons.

Weight of engine in working order—

ENGINE—

				Tons.	cwt.	qrs.
On bogie wheels	18	4	0
On driving wheels	15	13	0
On trailing wheels	14	18	0
				<hr/>		
Total engine	48	15	0

TENDER—

					Tons.	cwt.	qrs.
On first pair of wheels	9	18	0
On middle	10	8	0
On third	11	14	0
<hr/>							
Total	32	0	0
Total engine and tender in working order	80	15	0
<hr/>							
Total wheel-base of engine and tender	44	3 $\frac{1}{2}$
Total length over buffers	53	8 $\frac{3}{8}$

One cast-iron brake-block is fitted to each coupled and tender wheel applied by "steam"; the engine is also provided with the necessary apparatus for working the automatic vacuum brake upon the train.

Mr. Adams has also designed and constructed another type of locomotive for either passenger or goods traffic, these new engines being employed to run express goods between London and Exeter, and also upon heavy excursion traffic.

They are tender engines running upon six wheels, having four coupled wheels in front and a small pair of trailing wheels under the foot-plate.

" 530 CLASS."

Diameter of cylinders	18 ins.
Length of stroke	26 "
Diameter of coupled wheels	6 ft.
Length of boiler barrel	11 "
Number of tubes	218
Diameter of tubes (outside)	1 $\frac{1}{2}$ in.
Heating surface of tubes	1131.4 sq. ft.
Heating surface of fire box	116.7 "
<hr/>					
Total	1,248.1 "
<hr/>					
Area of fire-grate	17 sq. ft.
Pressure of steam	160 lb. per sq. in.

Weight in working order—

				tons.	cwt.	qrs.
On leading wheels	15	6	0
On driving wheels	16	8	0
On trailing wheels	10	13	0
Total engine				42	7	0
Weight of tender loaded				30	2	0

Grand total of engine and tender .. 72 9 0

Length of wheel base of engine and tender.. 38 ft. 1½ in.

The new class of tank engine, 62 type, for working local passenger trains, runs on eight wheels and has inside cylinders.

The four coupled wheels are 5 ft. 7 ins. diameter, placed in front, and a four-wheeled bogie is placed under the foot-plate. The cylinders are 18 by 26.

Weight in working order—

				Tons.	cwt.	qr.
On leading wheels	17	3	0
On driving wheels	18	0	0
On bogie wheels	17	0	0
Total				52	3	0
Total heating surface				1,248 sq. ft.

The South-Western Company provides its engines with the Adams Vortex blast-pipe, which instead of being a simple tapered pipe, as generally employed, has a central tube through which the heated air from the lower rows of tubes is drawn. This blast-pipe is found to fully answer expectations, as will be seen from the following official statement.

From June, 1885, to June, 1889, the company mixed the coal in proportion of two-thirds Welsh coal to one-third hard coal; since that time, in consequence of the increase in price of Welsh coal, the proportion is reversed, and in consequence the consumption is increased, and thus destroys the means of comparison with former years. (See next page.)

[Copy.]
LONDON AND SOUTH-WESTERN RAILWAY COMPANY.—FUEL CONSUMPTION, &C.

Half-year ended	Number of Engines fitted with the Vortex Blast-Pipe.	Number of Engines fitted with the Plain Pipe.	Total number of Engines.	Total Engine Miles.	Consumption of Fuel per Engine Mile.	Total Fuel Consumption.	Cost of Fuel per Ton.	Total cost of Fuel.	Saving from Half-year ended June 1886.	
									Tons.	£
June 30th, 1885 ..	nil	505	505	7,501,154	lb. 29·9	Tons. 100,246	14·40	£ 72,226	—	—
December 31st, 1885 ..	9	496	505	7,915,420	29·2	103,310	14·58	75,327	2,473	1,803
June 30th, 1886 ..	49	492	541	7,465,775	28·8	95,905	14·27	68,453	3,666	2,616
December 31st, 1886 ..	147	389	536	8,113,054	27·9	101,368	13·58	68,871	7,243	4,918
June 30th, 1887 ..	230	299	529	7,849,985	27·3	95,821	13·39	64,164	9,111	6,100
December 31st, 1887 ..	253	281	534	8,528,045	26·3	100,158	13·40	67,166	13,705	9,182
June 30th, 1888 ..	278	256	534	8,156,403	26·5	96,356	13·42	64,660	12,380	8,307
December 31st, 1888 ..	301	247	548	8,508,771	26·8	102,129	13·51	69,005	11,775	7,954
June 30th, 1889 ..	324	226	550	8,166,380	27·3	99,685	12·98	64,715	9,478	6,151
									Total £47,031	

Previously to the South-Eastern and Chatham amalgamation, the South-Eastern engines were designed by Mr. James Stirling and constructed at Ashford; they have a leading bogie and four coupled 7-foot wheels; the cylinders, placed inside, are 19 inches diameter and the stroke 26 inches.

The results of the working of six of these engines stationed at Dover, and each running about 1,000 miles per week upon mail and express trains between Dover and London, were as follows, and show very clearly the influence of weather and working generally during three different seasons of the years since the design was introduced.

MAY.

Average load 12 vehicles = 120 tons	}	= 190 tons.
Engine and tender .. 70 "		
Average coal per train mile, 27·62 lbs.		

NOVEMBER.

Average load same as above, 190 tons.
Average coal per train mile, 30·37 lbs.

AUGUST.

Average load 15 vehicles = 150 tons	}	= 220 tons
Engine and tender .. 70 "		
Average coal per train mile, 28·72 lbs.		

The London, Chatham, and Dover Railway employed engines designed and constructed by Mr. William Kirtley at its Longhedge Works. They have a leading bogie, four coupled wheels of 6 feet 6 inches diameter.

The cylinders are $17\frac{1}{2}$ inches diameter, by 26 inches stroke, the coupled wheels being 6 feet 6 inches diameter, and the tractive force therefore—

$$\frac{17\frac{1}{2}^2 \times 26}{78} = 102 \text{ lbs.}$$

for every lb. effective pressure on the piston. The boiler pressure is 150 lbs. per square inch.

The weight on the coupled wheels is $27\frac{3}{4}$ tons, or 62,160 lbs., and a tractive force equal to $\frac{1}{3}$ of the weight

available for adhesion would be given by a mean effective pressure of—

$$\frac{62160}{102 \times 5} = 121.8 \text{ lbs.}$$

per square inch, for which the cut-off required would be about 65 per cent. of the stroke.

The boiler, barrel, and fire-box shell are of best Yorkshire iron, the barrel made in two plates only, the circumferential seams being lap jointed and single riveted, and the longitudinal seams butt jointed and double riveted.

The top and sides of the shell are formed of one plate. The inside fire-box is of copper, the crown and sides in one plate, and the crown stayed by wrought-iron bars, secured by studs screwed through the crown plate into the bar with nuts on the underside. The fire-box stays are of copper. The back plate of the shell and the front tube plate are stayed by direct longitudinal stays, and the fire-box tube plate to the barrel by palm stays riveted to the latter.

	ft.	ins.
Height of centre of boiler from rail	7	2
Length of barrel	10	3
Diameter of barrel outside at largest part ..	4	3
Thickness of plates		$\frac{1}{8}$
Length of fire-box shell outside	5	9
Width of ditto at bottom	3	11
Depth of ditto from centre of boiler ..	5	2
Thickness of ditto plates	0	$0\frac{1}{2}$
Water space between fire-box and shell at bottom	0	3
Thickness of fire-box plates	0	$0\frac{1}{2}$
Ditto tube-plate	0	$0\frac{1}{2}$
Number of tubes, 199 (brass)		
Diameter of ditto outside	0	$1\frac{1}{2}$
Pitch of ditto	0	$2\frac{1}{2}$
Heating surface tubes	963	square feet.
Ditto fire-box	107	„ „

Total .. 1,070
Grate area 16.5 square feet.

The fire-box is fitted with brick arch and deflector plate on the inside, and sliding doors on the outside, these being fitted with an auxiliary door or valve for regulating the admission of air to the fire-box, the main or sliding doors being always closed when running, so that no glare or heat from the fire is thrown on to the footplate or into the cab, to incommode the men, or affect their clear view of the signals by night. The grate bars are $1\frac{1}{4}$ inches wide at the top, and of wrought iron with $\frac{1}{2}$ -inch air spaces.

The London, Tilbury and Southend Railway works its passenger traffic with large ten-wheeled tank engines, having a leading bogie, four coupled wheels of 6 feet diameter, and a trailing pair of small wheels, the cylinders placed "outside" and 17×26 . The total weight of these engines is 56 tons.

The latest tank engines for the North London Railway have been designed and built by Mr. Park at Bow; they have outside cylinders $17\frac{1}{2} \times 24$, a leading bogie, four coupled wheels, and a steam pressure of 180 lbs. per square inch.

The North London Company's main line extends from Broad Street station to the junction with the London and North-Western system at Chalk Farm, and it has branches to Poplar and at Bow which bring up the total length of the railway to twelve miles.

The Company also is joint lessee with the North-Western and Midland of the North and South-Western Junction Railway, and by means of running powers over portions of the Great Northern, London and North-Western, and other lines, its trains traverse the western, northern, and eastern suburbs of London.

The traffic is heavy, the gradients severe (being 1 in 59 at Highgate), and the stations about half a mile apart.

The average mileage of the whole of the North London Company's engines equals 46,000 miles per annum, and the average fuel is 30 lbs. of coal per train mile.

The North London was one of the first companies to see and take advantage of high steam pressure. When other lines were using 120 lbs. and 140 lbs. per square inch, this line employed 160 lbs. with excellent results.

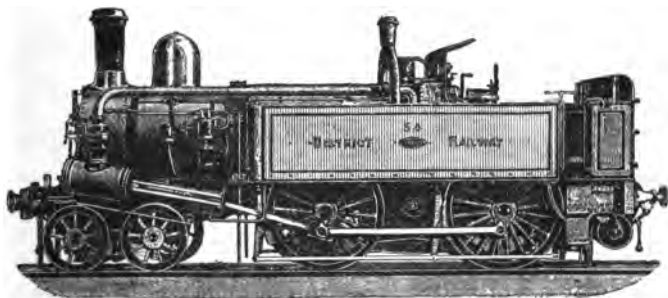

Fig. 83.—Metropolitan District Engine.

The Metropolitan and Metropolitan District Railways have both for many years worked their heavy and continuous passenger traffic with leading bogie, outside cylinder, four-coupled passenger tank engines, having cylinders 17×24 , and wheels 5 feet 9 inches. However, the latest Metropolitan engine has inside cylinders and a trailing bogie.

Fig. 83 shows that the engine has a leading bogie, four coupled wheels, and outside cylinders. This class of tank engine was originally designed for the underground railways by Sir John Fowler. On the opening

of the Metropolitan District Railway, the locomotive stock consisted of twenty-four of these engines, since increased to fifty-four, the whole of which have been built by Messrs. Beyer, Peacock & Co., of Manchester. These engines have proved remarkably satisfactory, as is clearly shown by the fact that when ordering new ones it has been found unnecessary to make any changes of importance in the dimensions. The chief dimensions of No. 54 are as follows:—

Diameter of cylinders (17)	ins.	1 5
Length of stroke (24)	2 0
Length of ports	1 1 $\frac{1}{2}$
Width of steam ports	0 1 $\frac{3}{4}$
Width of exhaust ports	0 2 $\frac{1}{2}$
Between centres of cylinders	6 0
Between centres of valve spindles	2 10 $\frac{1}{2}$
Diameter of piston rods	0 2 $\frac{1}{2}$
Lap of valves	0 0 $\frac{1}{2}$
Lead of valves	0 0 $\frac{1}{2}$
Throw of eccentrics	0 2 $\frac{1}{2}$
Diameter of bogie wheels (new)	3 0
Diameter of coupled wheels (new)	5 9 $\frac{1}{2}$
Total wheel base	20 9
Diameter of boiler (inside)	4 0
Length of boiler, between tube plates	10 6 $\frac{3}{4}$
Diameter of tubes	0 2
Number of tubes	164
Working pressure of steam	130 lbs.
Diameter of blast-pipe	0 5 $\frac{1}{2}$

When working in tunnels the exhaust steam is discharged into the water tanks.

Weight in working order:—

On bogie wheels	tons. cwts.	10 17
On driving wheels	18 1
On trailing wheels	17 12
					Total	<u>46 10</u>

On journeys round the "inner circle" the author finds the number of booked stops is twenty-seven, in

addition to which there are always several due to signals; the distance is thirteen miles, and the time occupied in running sixty-eight minutes. The load hauled on all the circle trains and also over the gradients above mentioned is a train of nine coaches weighing from 75 to 87 tons empty. There are also a few local trains of five coaches running between High Street, Kensington, Putney Bridge, Earl's Court, Chiswick Park, and on the Hounslow branch.

The entire stock of the Metropolitan District Company, consisting of fifty-four engines and 350 carriages, is fitted with the Westinghouse automatic brake, and it is a fact worthy of note that although constantly stopping trains this brake works without a single fault or delay being caused.

The Company's locomotives undergo a general repair once in about two and a half years, and are practically in constant work from one general repair to the next, one shed day in seven being the only time they are cold.

The author finds the coal sheet to be remarkably good, considering the constant starting of trains, the heavy work, and severe gradients, the average consumption being less than 30 lbs. per mile. It must also be remembered that the entire railway consists of curves, there being hardly any straight road, and many of the curves are so sharp as to require check rails.

The Great Eastern Company has several useful classes of express engine, in addition to those illustrated, Fig. 79, namely the old "single" engines designed by Mr. Sinclair, and the large bogie express engines of the 602 class, having cylinders 18×26 and driving-wheels 7 feet 6 inches diameter.

The Coupled Compound Engine, No. 230, built by Mr. Worsdell, has since been altered.

The Lancashire and Yorkshire Railway, having heavy gradients and frequent stoppages, requires engines of considerable power. That company, therefore, employed engines having a leading bogie, four coupled wheels of 6 feet diameter, and cylinders $17\frac{1}{2} \times 26$, also a later class having cylinders 18×26 and 7 feet 3 inches coupled wheels.

The North British Railway is also one requiring power: we therefore find bogie express engines with four coupled wheels of 6 feet 6 inches diameter and cylinders 18 by 26.

On the Caledonian Railway several powerful engines are employed. Mr. Drummond had constructed bogie express engines with cylinders 18 by 26 and 6 feet 6 inches coupled wheels, and engine No. 124 had 19 inch cylinders, now reduced to 18. Boilers with various pressures from 150 to 200 lbs. per square inch have also been tried upon this railway.

The tank engines for working the passenger traffic between Liverpool and Birkenhead through the Mersey tunnel are of exceptional power, the gradient to be ascended being no less than 1 in 27; the engines of the No. 1 class have six coupled wheels of 4 feet 7 inches diameter and a trailing bogie, the cylinders are 21 inches diameter and 26 inches stroke, the total weight of this engine being 68 tons. This great power and weight enable these engines to stop at any point within the tunnel, and start away with their trains upon the heavy gradient of 1 in 27.

From the opening of the St. Pancras Station for the Midland Company's main line trains, in 1868, until the

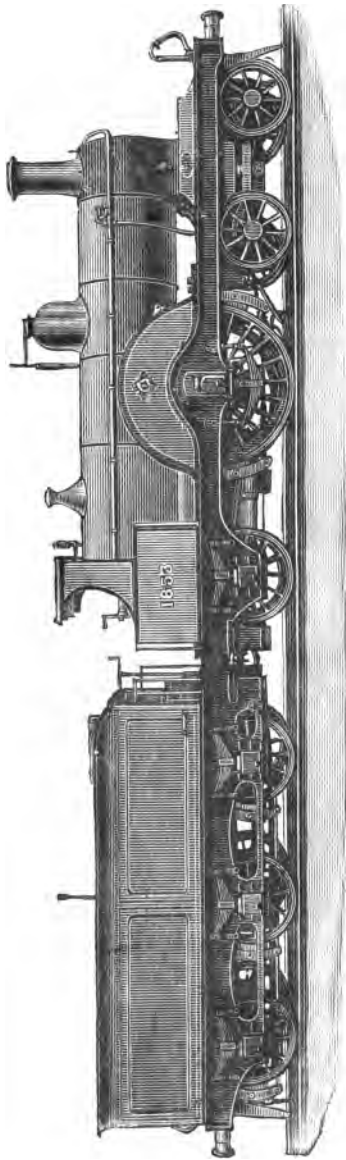

Fig. 84.—Midland Express Engine, No. 1853 (1859).

year 1887, the whole of the express trains to London were worked by engines having four wheels coupled, but in that year Mr. S. W. Johnson designed and constructed some engines having a "single" pair of driving wheels, 7 feet 4 inches diameter, cylinders 18 by 26 and steam pressure 160 pounds. Two years later, 1889, he designed a still larger class (see Fig. 84) having cylinders $18\frac{1}{2} \times 26$, and 7 feet 6 inches wheels.

Total heating surface	1,240 sq. ft.
Pressure of steam	160 lbs.
Weight on driving wheels	17 $\frac{1}{2}$ tons.
Weight of engine in average working order	43 tons.
Weight of tender	30 "
	<hr/>
Total	73 tons.
Tender, water capacity	3,250 gallons.

Numbers of the "Single" engines are running between London and Leeds, London and Nottingham, and Liverpool to Marple, also between Bristol and Derby. The fact that engines of this type are working the main line express trains over the London line, having severe gradients (see Fig. 85)—for instance, Irchester and Sharnbrook of 1 in 120—at high speed, and upon a coal consumption of 28 to 32 pounds per mile, is the most convincing proof of their great efficiency.

Considering the loads, speed, and gradients, the work which has to be performed between London and Leicester is as hard or harder than any locomotive work in the country. Leaving London, the line rises for about 12 miles to Elstree, thence followed by a fall of 1 in 200 for about two miles to Radlett, when the rise continues to Leagrave. The engine, therefore, has

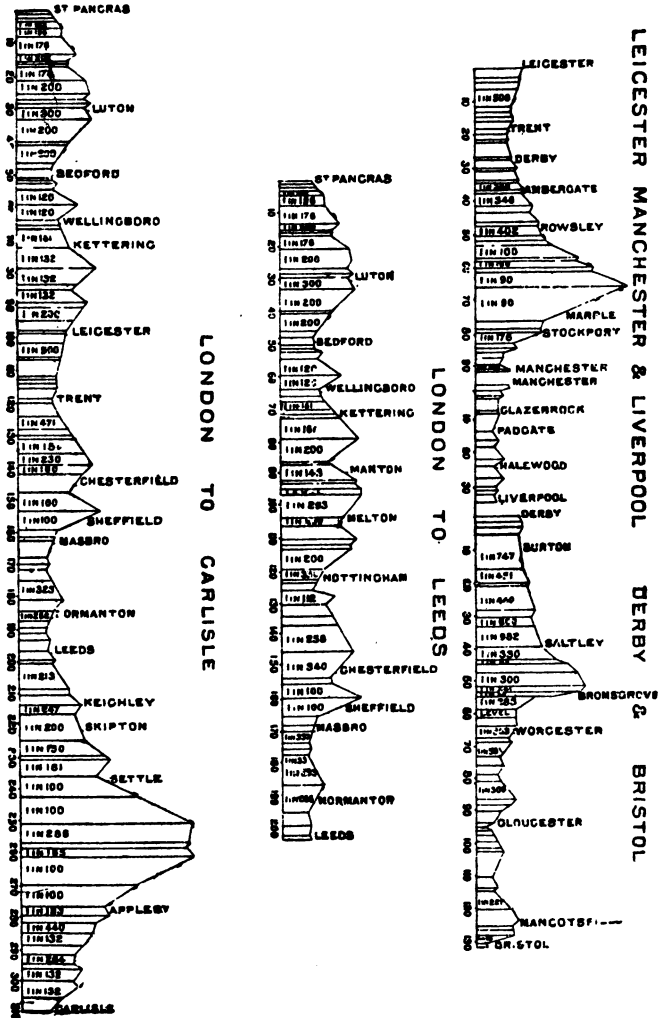

Fig. 86.—Section showing Gradients of Midland Railway.

practically a constant pull up 1 in 176, and 1 in 200, until it has run 33 miles, when the line falls to Bedford upon gradients of 1 in 200, and speed has to be reduced to 15 miles an hour passing that station, which is a bad beginning for the rise to Sharnbrook summit, which is the top of both the Sharnbrook and Irchester Banks, of 1 in 120. Having run down to Wellingborough, the up-hill work continues past Kettering to the Desborough North Box, which is at the summit of two banks, of 1 in 132, and from Market Harborough up-hill work follows to the summit at Kibworth North Box, thence (with the exception of a dip at Glen) the line falls to Leicester. It will thus be seen that there are long lengths of 176, 120, 132, and at Kibworth a short length of 1 in 100. The Scotch trains now perform the distance, $99\frac{1}{4}$ miles, with a load of $10\frac{1}{2}$ coaches, in 115 minutes.

The Nottingham expresses are allowed 80 minutes between Kentish Town and Kettering, $70\frac{1}{2}$ miles, or an average from start to stop of nearly 53 miles an hour; and when riding in the trains the writer has very frequently timed the run in less than 78 minutes, and upon no occasion has he been a passenger when one of these engines has ever lost any time.

The "Greater Britain," designed and constructed by Mr. Webb at Crewe, ran its first trip on the 4th November, 1891.

The general principle of the design of the "Greater Britain" is identical with the other compounds. The high-pressure cylinders are 15 inches diameter, and the low-pressure cylinder is 30 inches diameter, the stroke in each case being 24 inches. As far as tractive force is concerned, the engine is said to be equivalent

to a non-compound locomotive having a pair of 21-inch cylinders with a 2-foot stroke, the driving wheels being 7 feet 1 inch diameter.

The special feature in the “Greater Britain” is the design of the boiler, which has been made with a very long barrel to allow of both driving-axes being placed under it. The tubes are divided into two lengths by a combustion chamber, those extending from the fire-box to the combustion chamber being 5 feet 10 inches long between tube-plates, while those forming the front group are 10 feet 1 inch long.

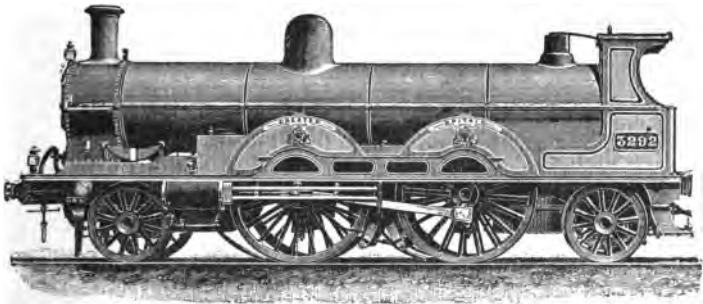

Fig. 86.—Mr. Webb's Compound Engine, “Greater Britain,” built 1891.

Heating surface of firebox	120 6 sq. ft.
“ “ combustion chamber	39·1 “ “
“ “ tubes (front)	853·0 “ “
“ “ tubes (back)	493·0 “ “
Total	1,505·7 sq. ft.
Pressure of steam	175 lbs. per sq. inch.
Weight of engine in working order ..	52 tons 2 cwts.
Weight of tender	25 “ “
Total	77 tons 2 cwt.

Sufficient time has not yet elapsed for this engine to prove her cost of maintenance ; but, so far, facts appear to show that the difficulties which attend "compound" express engines have not yet been successfully overcome.

The following particulars of the London and North-Western route show the gradients over which the engines work.

Leaving Euston the line passes under the Hampstead Road and immediately commences to rise upon gradients of 1 in 66, 1 in 110, 1 in 132, and 1 in 75 to Camden. Having once overcome the Euston incline, the engine has before it a splendid run to Crewe. There are summits at Tring, Blisworth, Kilsby, Atherstone, and Whitmore ; but with the exception of the rise near Whitmore, the engines upon either the up or down journey have practically to work throughout upon gradients of not more than 1 in 330, or 16 feet per mile.

North of Crewe the gradients become more severe until, upon passing the 243rd mile-post, the engine commences to ascend long and severe gradients, and from Tebay to Shap-summit, a "bank engine" is employed to assist the trains up the incline of 1 in 75, after which the line falls to Carlisle.

The most severe gradient is 1 in 75 going north, and 1 in 95 between Carlisle and Shap travelling south. It is under consideration to make a tunnel and new line under Shap-summit. If this plan be carried out, both these severe gradients will be avoided.

During the year 1891, and early part of 1892, thirty new express engines were built at the Swindon works of the Great Western Railway from the designs of Mr.

William Dean, to take the place of the broad gauge engines on the 23rd May, 1892.

The new engines are numbered from 3,001 to 3,030, and run upon six wheels, have double frames, a single pair of driving wheels, 7 feet 8 inches diameter, and a pair of inside cylinders no less than 20 inches diameter (Fig. 87).

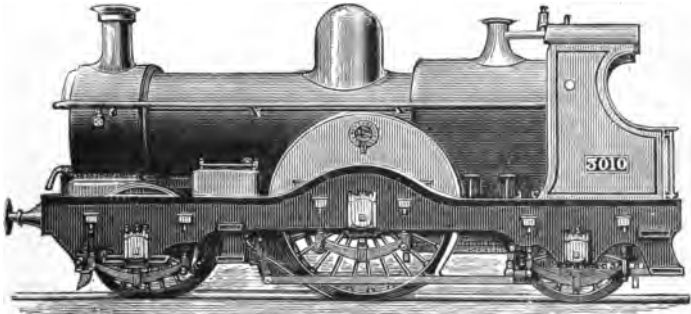

Fig. 87.—Mr. Dean's Design of 1891.

The chief dimensions of these splendid locomotives being as follows:—

Diameter of cylinders	20 ins.
Length of stroke	24 "
Diameter of driving wheels	7 ft. 8 ins.

The tractive force exerted for each pound of effective steam pressure per square inch in the cylinders being, therefore, thus—

$$\frac{20 \times 20 \times 24}{92} = 104.3478$$

The steam pressure carried being 160 lbs. per square inch, and the weight available for adhesion 19 tons,

it follows that the engines are capable of performing fast and very heavy work. The boilers of these new engines are provided with a dome, an advantage which the old engines (Figs. 44 and 54) did not have.

Distance apart between centres of cylinders ..	2 ft. 3 ins.
Length of boiler between the tube plates ..	11 ft. 9 $\frac{1}{2}$ ins.
Mean diameter of telescopic boiler inside ..	4 ft. 1 $\frac{1}{2}$ ins.
Number of tubes	246
Diameter of tubes (outside)	1 $\frac{1}{2}$ ins.
Pressure of steam	160 lbs.
Heating surface of tubes	1,321·04 sq. ft.
Heating surface of fire-box	123·88 „ „
	<hr/>
	1,444·92 „ „
Area of fire-grate	20·8 sq. ft.
Length of wheel-base	18 ft. 6 ins.

Weight of engine in working order—

On leading wheels	13 tons 4 cwts.
On driving wheels	19 „ 0 „
On trailing wheels	11 „ 18 „
	<hr/>
Total	44 „ 2 „
Weight of tender full	32 „ 0 „
	<hr/>
Grand total, engine and tender ..	76 „ 2 „

The tender runs upon six wheels, and carries 2 $\frac{1}{2}$ tons of coal, and 3,000 gallons, or 13 tons 7 cwts. and 96 lbs., of water.

It is an admitted fact that the “battle of the gauges” has ended completely in favour of the narrow gauge; however, now the Great Western Company has made the change, it has given proof that it intends to have some of the finest narrow-gauge express engines that can be constructed. When we see the fine new engines which Mr. Dean has built for the 4 feet 8 $\frac{1}{2}$ inch gauge, we cannot help feeling great regret

that Mr. Brunel did not devote his great skill and energy to the perfecting of the narrow-gauge engine, instead of introducing a wide gauge which has now had to be removed.

The gradients upon the Great Western Railway between London and Bristol are, with two exceptions, extremely favourable.

Leaving Paddington the line rises very gradually for about 11 miles to near Hayes, thence there is a decline of one in 1,716; from West Drayton to Swindon there is a very gradual rise, but the gradients are only about 1 in 1,320, 1 in 660 being the most severe.

Near to Dauntsey, there is about $1\frac{1}{2}$ miles of 1 in 100, and through Box Tunnel the gradient is also 1 in 100, these inclines in both cases being against the up trains. From Box to Bristol the line falls upon easy gradients.

The rise of 1 in 100 through Box Tunnel has often been described as the *bête noire* of engine drivers; however, it is not likely that they will be much troubled by engines "slipping" when the driving wheels carry 19 tons and are provided with a good supply of sand.

These new engines speedily proved beyond question that the broad gauge was a mistake, and that whatever could be done upon the wide gauge could be equally well done upon the 4 ft. $8\frac{1}{2}$ in. gauge.

Messrs. Sharp, Stewart & Co., of the Atlas Works, Glasgow, in 1892 placed twenty new bogie express engines upon the Midland Railway, built from Mr. Johnson's designs, Nos. 2,183 to 2,202; they have cylinders $18\frac{1}{2}$ by 26, 7-foot driving wheels, 4 coupled, and a steam pressure of 160 lbs. per square inch;

they are also provided with the apparatus for warming the carriages by hot water, now adopted by the Midland; and for working local passenger traffic upon the same line a number of "bogie" tank engines have been built, having four coupled wheels of 5 feet 3 inches, cylinders 18 by 24, and a pressure of 150 lbs.

The Great Southern and Western Railway Company of Ireland owns the main line extending from the Kingsbridge station, Dublin, to Queenstown, the distance being $177\frac{1}{4}$ miles; and it is by this route that passengers and mails are conveyed to and from Queenstown in connection with the American liners.

The gauge of the Irish railways is 5 ft. 3 ins.

For many years past the Great Southern and Western Company has built all its engines and rolling stock at its Inchicore Works, near Dublin.

The express engines in 1896 had inside cylinders, a leading bogie, and four coupled wheels.

				ft.	ins.
Diameter of cylinders	0	18
Length of stroke	0	24
Diameter of coupled wheels	6	6
Diameter of boiler	4	3
Length of boiler barrel	9	9
Diameter of tubes (outside)	0	$1\frac{3}{4}$
Length of tubes between tube plates	10	$0\frac{1}{2}$
Length of fire-box	4	10
Width of fire-box	3	11
Height of fire-box above grate	5	9
Pressure of steam	150 lbs. per sq. in.		
Number of tubes	204
Heating surface of fire-box	112 sq. ft.	
Heating surface of tubes	938	..
				<hr/>	
		Total	..	1,050	..
Area of fire-grate	$18\frac{1}{4}$..

Weight of engine in working order—

On bogie wheels	tons.	cwt.
					13	11
On driving wheels	12	17
On trailing wheels	12	16
					<hr/>	
Total	39	4
Weight of tender loaded	28	6
					<hr/>	
Grand total	67	10

The leading bogie is of the American swing-link pattern. The boiler and frame plates are of steel, and the motion plate is cast steel; the two cylinders are cast together in one piece, and have the back covers and air passages for the vacuum brake cast in; these passages being in communication with the ejector, which is placed in the smoke-box, in front of the blast-pipe.

The bearings of the small ends of the connecting-rods are iron, case-hardened, working on a case-hardened pin, this being the universal system of "little end" in use on the line. The four eccentric sheaves are cast in two pieces and put on the axle with four bolts; no keys are used, but a small dowel secures the correct position of the sheaves.

The tender runs on six wheels, and carries 2,700 gallons of water and four tons of coal.

The actual working upon the American mail and express trains between Dublin and Queenstown is as follows:—

On weekdays the mail starts from Dublin at 7.40 A.M., and arrives at Queenstown at 12.15 P.M. The time on the journey of $177\frac{1}{4}$ miles is, therefore, 4 hours 35 minutes, of which, however, 18 minutes are allowed at stations; the average speed, including stoppages, is therefore 42.16 miles an hour, which is found to mean

an average running speed of 45 to 50 miles an hour. On Sunday the mail is run at a somewhat higher speed. The average load is equal to $9\frac{1}{2}$ six-wheeled coaches.

Weight of engine and tender	tons.	cwt.
Weight of $9\frac{1}{2}$ coaches	67	10
			120	0
Total weight of train	<hr/>	
			187	10

The consumption of South Wales steam coal is from 24 lb. to 26 lb. per mile with this load. The weight of train frequently exceeds this average, and the engines are capable of working fifteen to eighteen vehicles without difficulty.

The gradients are not considered severe, with the exception of the incline at Cork of 1 in 60, and at Dublin of 1 in 85. There are, however, several short lengths of 1 in 172, 180, 128, 140, and 151.

The 75 class of engines for the Great North of Scotland Railway have been constructed by Messrs. R. Stephenson & Co., and are required to run 4,000 miles consecutively without showing any defects in material or workmanship, and they completed this mileage to the entire satisfaction of the Great North of Scotland Railway Company.

The engines are eight-wheeled, there being two pairs of coupled wheels 6 ft. $6\frac{1}{2}$ in. diameter and a four-wheeled bogie at the leading end, the bogie wheels being 3 ft. $9\frac{1}{2}$ in. diameter. The engines have inside cylinders 18 in. in diameter and 26 in. stroke, the cylinders being cast together in one piece, the slide valves being placed on the top of the cylinders, and driven by a link motion and rocking levers. This is a very neat arrangement, designed by Mr. Manson, and has given every satisfaction. The engines are fitted

with balanced slide valves, also designed by Mr. Manson. The pressure on the back of the valve is relieved by a ring, which is held up to the casing door by a light tripod spring.

This arrangement greatly reduces the wear and tear of the valves and gear, and since adopted on the Great North of Scotland Railway, engines have run 100,000 train miles, the wear of the slide valves being only $\frac{3}{16}$ in.

The bogie is provided with the ordinary swinging arrangement, which enables the engine to pass round curves with perfect steadiness. The main frames, which are of steel, are set in at the front end to give sufficient clearance for the bogie wheels. The wheels are of wrought iron, and the coupled wheels have the balance weights forged solid.

The boiler barrel and fire-box casing are of best Yorkshire iron, the internal fire-box and tubes being of copper. There are 1,087 square feet of heating surface in the tubes, and 106 square feet in the fire-box, giving a total heating surface of 1,193 square feet. The grate surface is 18 square feet; the fire-box is fitted with sixteen copper air tubes, 3 in. external diameter, No. 7 w.g. thick, in two rows of eight in front and back, for conducting streams of air into the fire-box. This arrangement has been successfully used on the Great North of Scotland Railway for upwards of thirty years.

The tender is carried on eight wheels, the four hind wheels being connected to the main frame of the tender, and the four front wheels are connected to a bogie of the same design and construction as the engine bogie. The tank carries 3,000 gallons of water and about three tons of coal. The weight of the

tender when loaded with coal and water is 36 tons. These tenders are remarkable as being the only ones running on a bogie in this country.

The Great Eastern Railway Company has just placed upon its line some powerful six wheels coupled tank engines, designed by Mr. James Holden, to work the very heavy suburban passenger traffic to and from Liverpool Street. In order to ascertain the work done, the author has ridden with some of the trains, and finds that the booked time from Liverpool Street to Enfield is 40 minutes, the distance $10\frac{1}{4}$ miles with 16 stops. If each stop averages one minute, including stopping and starting, the actual running time is only 24 minutes, equal to a speed of 27 miles per hour. This, it must be remembered, includes no allowance for speed orders, stoppages or slowages due to adverse signals, &c. These trains average 15 carriages, with a gross load of 250 tons.

The cylinders are $16\frac{1}{2}$ inches diameter, the stroke 22 inches, and the coupled wheels 4 feet diameter, the tractive force being therefore—

$$\frac{16.5 \times 16.5 \times 22}{48} = 124.7 \text{ lbs.}$$

Total heating surface	959 sq. ft.
Grate area	12.4 sq. ft.

Weight of engine in working order—

	tons.	cwt.	qr.
On the leading wheels	12	7	1
„ driving „	13	13	0
„ trailing „	13	19	3
			Total	40	0	0
Capacity of tanks	1,000 gallons.		

These engines are working most satisfactorily, and

have considerably reduced the consumption of coal per mile.

For shunting purposes, and for working small branch lines, tank engines are usually employed.

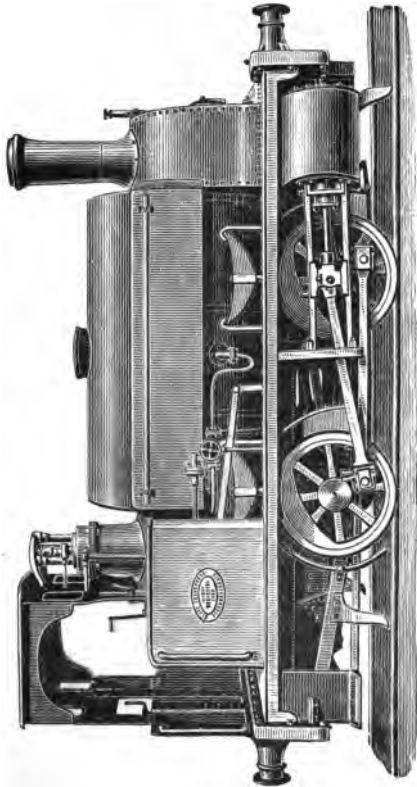

Fig. 88.—Four-wheeled Shunting Engine.

Fig. 88 illustrates a four-wheeled engine of the standard type manufactured by Messrs. Black, Hawthorn and Co., of Gateshead; and Fig. 89 illustrates a

more powerful engine which runs on six wheels, built by the same firm. The dimensions are varied in accordance with the work required, but most generally

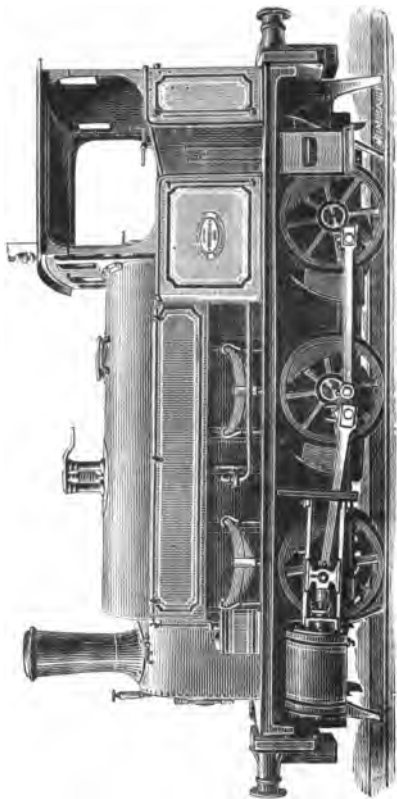

Fig. 89.—Six-wheeled Shunting Engine.

the cylinders are about 15 inches diameter, and the stroke about 20 inches, the coupled wheels being 3 feet diameter. A small but at the same time a useful and very powerful engine is thus obtained.

CHAPTER V.

IMPORTANT DEVELOPMENTS.

THE Great Western Company's thirty engines, Nos. 3,001 to 3,030, illustrated in Fig. 87, p. 167, were gradually sent to the Swindon works to have a four-wheel leading bogie placed in front, to supersede the pair of leading wheels, and at the same time the cylinders were reduced from 20 inches to 19 inches diameter.

Mr. Dean also designed and constructed at Swindon the "Achilles" class, of which there are thirty examples, No. 3,031 being the first (Fig. 90). The dimensions are as follows:—

Diameter of cylinders	19 in.
Length of stroke	24 in.
Diameter of driving wheels	7 ft. 8 in.
Heating surface of tubes	1,434 sq. ft.
" " " fire-box	127 " "
Total	1,561 " "
Area of fire-grate	20·8 sq. ft.
Boiler pressure	160 lbs. per sq. in.
Weight on driving wheels	18 tons.
Total weight of engine	49 "
" " " tender	32 tons 10 cwts.
Grand total in working order	81 tons 10 cwts.

These engines are giving very satisfactory results upon the heaviest and fastest main line trains between

London, Bristol, and Newton Abbot, and their coal consumption is found to be between 31 and 33 lbs. per mile with these trains.

Mr. Dean, in 1894, placed the "Armstrong" class upon the Great Western Railway (Fig. 91).

Diameter of cylinders	20 in.
Length of stroke	26 "
Diameter of coupled wheels	7 ft.

The tractive force exerted for each pound of effective steam pressure per square inch in the cylinders being thus:

$$\frac{20 \times 20 \times 26}{84} = 123.8 \text{ lbs.}$$

The valves are placed under the cylinders and are worked by link motion. The steam pressure being 160 lbs. per square inch, and the weight available for adhesion, 31 tons 10 cwt., it follows that the engines are capable of performing fast and very heavy work.

The boiler has 1,561 square feet of heating surface, and is the same design as that used in the "Achilles" type.

The weight in working order of No. 7 is thus:—

On first bogie wheels	9 tons 13 cwts.
„ second bogie wheels	9 „ 13 „
„ driving wheels	15 „ 18 „
„ trailing wheels	15 „ 12 „
Total	50 tons 16 cwts.
Weight of tender	32 „ 10 „
Grand total	83 tons 6 cwts.

A comparison of Figs. 90 and 91 will show that the two types are very similar, but with the important exception that the latter are "coupled" engines, and have larger cylinders.

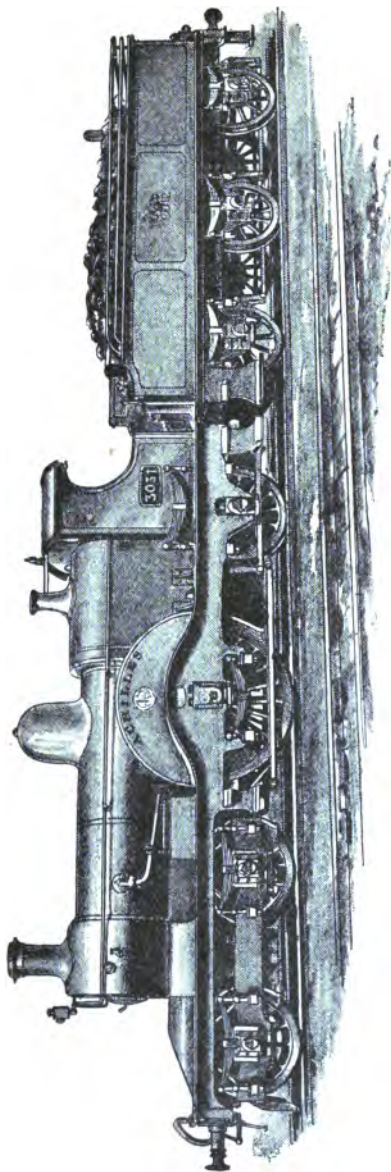

Fig. 90.—The Great Western Company's *Achilles*, "Single" design.

For working the West of England expresses over the heavy gradients in the Cornwall district, Mr. Dean has recently constructed some powerful coupled bogie engines, with small driving wheels of 5 ft. 8 in. diameter; this class is similar to "Pendennis Castle," No. 3,253, and is giving very good results. The American extension front, or smoke-box, is found very satisfactory in preventing the throwing of sparks.

The 1620 type of express engines upon the North-Eastern Railway, designed by Mr. Wilson Worsdell, are doing some remarkably good work. They have cylinders 19 by 26 ins., four coupled wheels 7 feet diameter, a leading bogie, boiler pressure 180 lbs. per square inch, and piston valves.

At a brake trial which the Author attended, in 1895, one of these engines, No. 1,621, worked the trial train, which consisted of no less than thirty six-wheeled coaches, and during the recent "race to Aberdeen" No. 1,621 ran from York to Newcastle, 80½ miles, in 79 minutes; and No. 1,620 ran from Newcastle to Edinburgh, 124½ miles, at an average speed of 66 miles an hour throughout.

All Mr. Worsdell's engines continue to be provided with a comfortable "cab," and it is a matter for regret that these are not yet being adopted for engines on other lines.

The Glasgow and South-Western express engines—as shown in Fig. 69, p. 122—had no dome on the boiler; the Company has now improved the efficiency of its engines by adopting the use of a steam dome.

The Midland Railway Company, at the Derby works has continued to build "Single" express engines very similar to but larger than that shown, Fig. 84 (p. 161),



pled" design, 1894.

[To face p. 180.

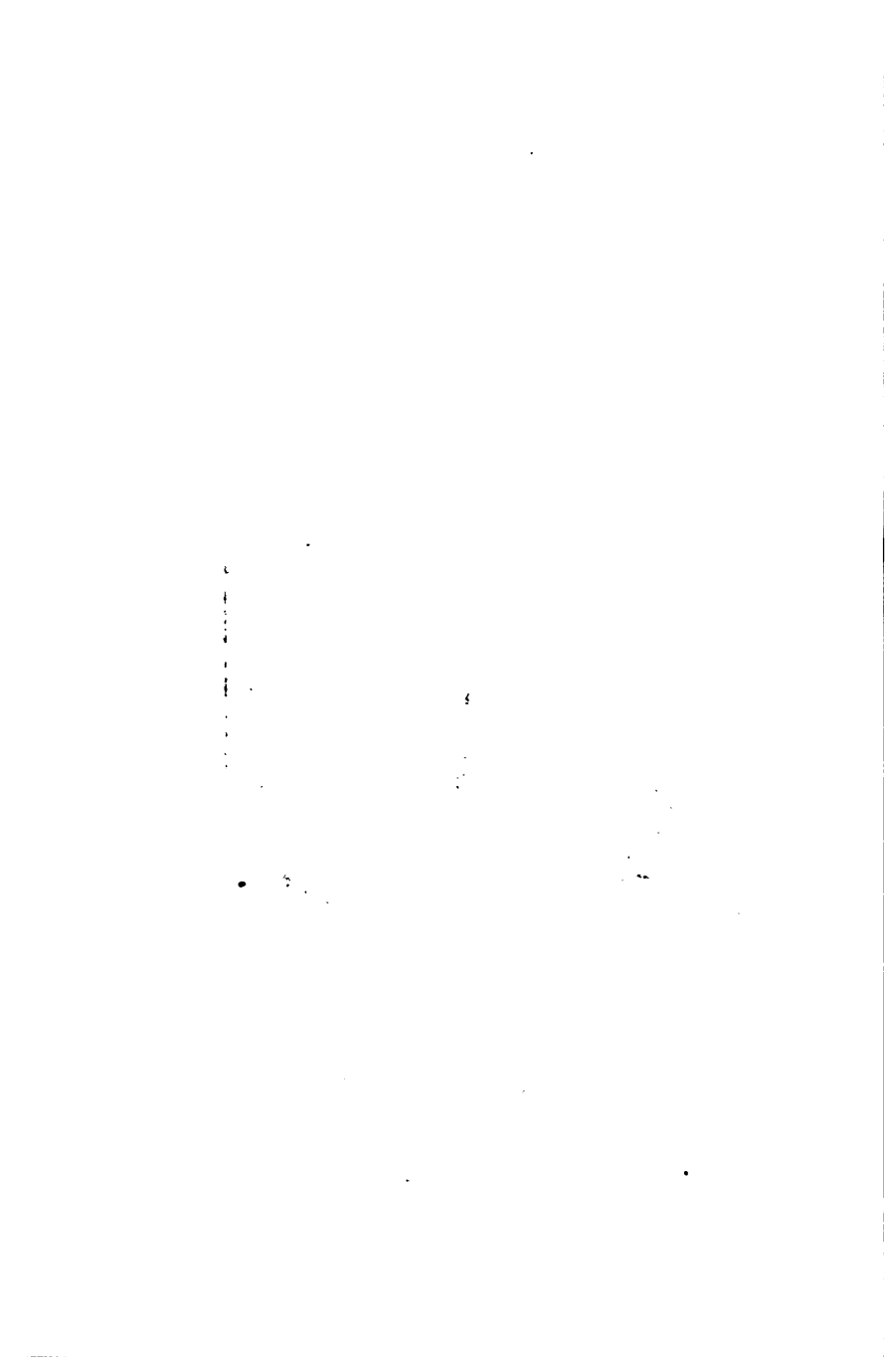

as well as coupled engines, with wheels of 6 feet 9 inches and also 7 feet diameter for the most severe gradients.

At Crewe, the London and North-Western has constructed more engines of the "Greater Britain" design (Fig. 86, p. 165). This Company's engines have for many years been constructed with a leading pair of wheels, and radial axle boxes, but at the present time the subject is engaging attention, and the investigation will probably lead to a change, as there can be no question that a four-wheeled leading bogie is far more safe and efficient than any system of radial axle.

In the previous edition of this work, the dimensions were given of the large "Winby" engine, specially designed for exhibition at Chicago in 1893, which naturally engaged much attention in America. When put into regular working, however, it failed to supply sufficient steam to its four cylinders, and for many years it was rusting on a siding at Milwaukee. This result shows that it was very unwise to send the "James Toleman" to America, quite new, without any experiments being first made in this country.

Messrs. Sharp, Stewart & Co. in 1894 completed an order for twenty-six bogie passenger engines for the Midland and Great Northern Joint Railway, which in construction are very similar to the Midland coupled engines, but in external appearance they are distinguished by being painted yellow. They were designed by Mr. S. W. Johnson, and have cylinders $18\frac{1}{2}$ inches \times 26 inches, and four coupled wheels of 6 feet 6 inches diameter, and are doing very good work between Lynn, Cromer, and Yarmouth. These engines form one of the very few instances of locomotives being the joint property of two companies.

The latest construction of tank engine for working through the Mersey Tunnel has outside cylinders $19\frac{1}{2}$ inches \times 26 inches, and 6 coupled wheels of 4 feet 7 inches diameter, and also a small pair of wheels with radial axle boxes at each end of the engine.

The heavy passenger traffic on the North London Railway is worked by tank engines having a leading bogie, four coupled wheels, and outside cylinders; the No. 72 type designed by Mr. Pryce have cylinders $17\frac{1}{2}$ inches \times 24 inches, coupled wheels 5 feet 5 inches, and a total weight in working order of 46 tons.

The new engines for working the very heavy summer coast traffic on the Cambrian Railways have been designed by Mr. Aston, locomotive superintendent, and were constructed by Messrs. Sharp, Stewart & Co. They have a leading bogie, and four coupled wheels of 6 feet diameter, the cylinders being 18 inches \times 24 inches. The gradients between Whitchurch and Aberystwith are very severe, and necessitate the use of comparatively small wheels.

During the "race to Aberdeen," the Caledonian coupled bogie engines designed by Mr. Drummond, and also by Mr. Lambie, have worked the West Coast trains with very marked success; they have cylinders 18 inches \times 26 inches, and 6 feet 6 inches coupled wheels, the steam pressure being 150 lbs.

The late Mr. P. Stirling, at Doncaster, in 1895 built six more engines of his 8 feet design (Fig. 78, p. 138).

The last of these have cylinders $19\frac{1}{2}$ in. \times 28 in., and a boiler pressure of 175 lbs. The object in constructing these engines of such great power was to avoid

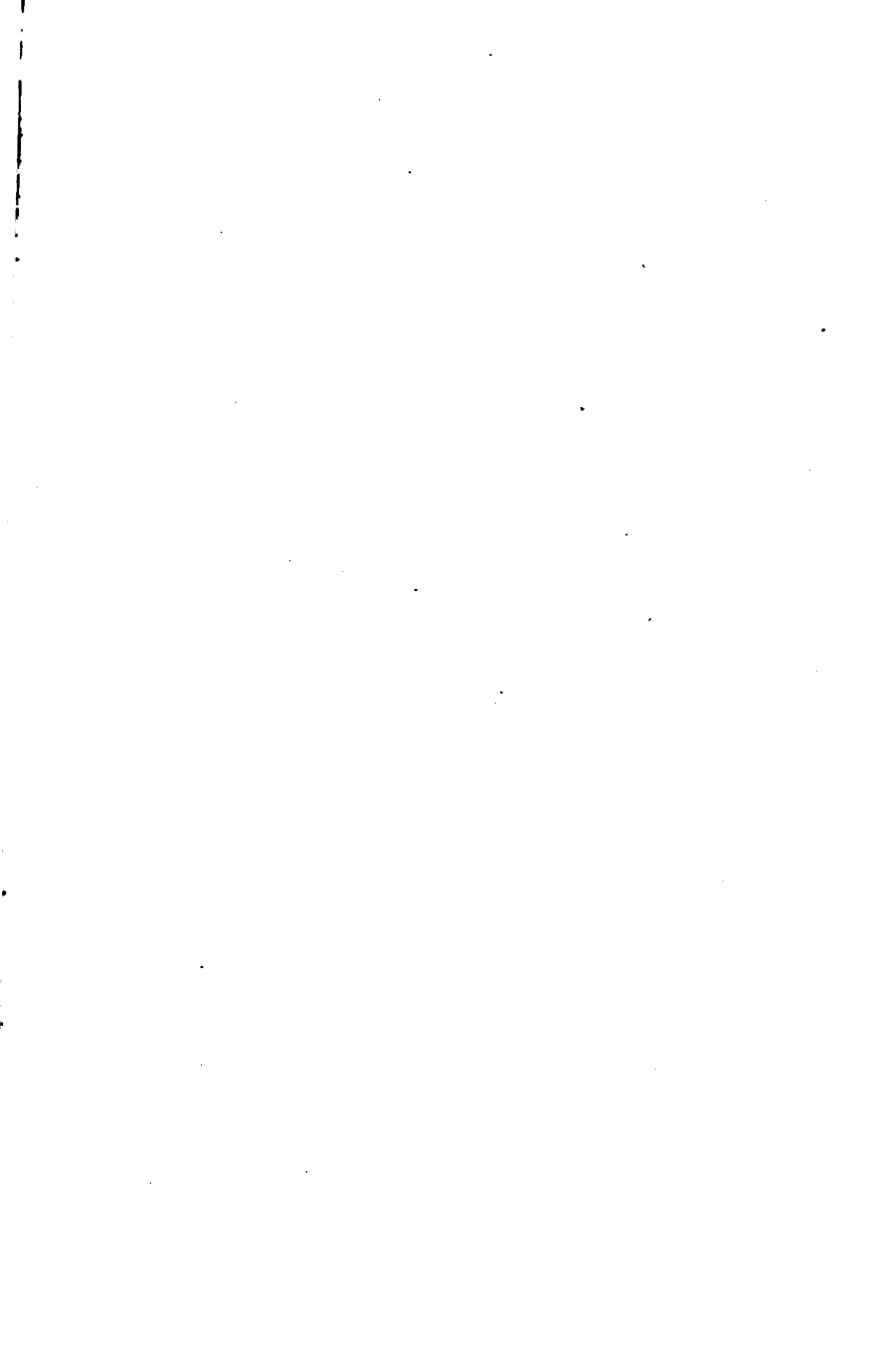

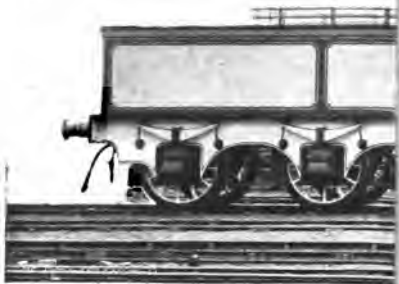

Fig. 92.—Bogie

the use of a second engine on any train, and to provide power for any future race to Scotland, it being understood in 1895 that there would be a continuation of the "racing" in the summer of 1896.

The Highland Railway Company introduced the use of what in America is known as the ten-wheeled engine, having a leading bogey and six coupled wheels; these engines are found to convey the heavy passenger summer traffic over the most severe gradients with great success.

The London, Brighton, and South Coast Company in 1895 turned out at the Brighton works three new leading bogie express engines, built from the designs of Mr. R. J. Billinton, locomotive superintendent. They have cylinders 18 inches \times 26 inches, coupled wheels of 6 feet 9 inches diameter, and a pressure of 160 lbs. (see Fig. 92). The business men who reside at Brighton are constantly asking for trains to and from London to perform the journey in an hour, and the new engines would have no difficulty in doing the work.

The Manchester, Sheffield, and Lincolnshire Company has placed some large coupled bogie engines on its line with 7 feet wheels and 170 lbs. pressure. They have been designed by Mr. Harry Pollitt.

The Midland Company constructed ten very large "single" engines for the Scotch traffic, the cylinders of which are $19\frac{1}{2}$ inches \times 26 inches, wheels 7 feet $9\frac{1}{2}$ inches. No. 2601 is named "Princess of Wales."

CHAPTER VI.

EIGHT-WHEELED COUPLED GOODS ENGINES.

FOR some time past it has been apparent that, with increased working expenses, some important step will have to be taken in order to increase the receipts per mile, especially of mineral trains.

Many of the railways are so crowded with passenger traffic that it is only by running coal trains at a high speed that they can be "got along at all." Long lengths of goods lines have been within the past few years opened, and the question of increasing the length and reducing the speed of coal trains to London must very soon be seriously considered. In order that coal traffic can be made to properly "pay," it should be conveyed in train loads of fifty waggons.

Messrs. Sharp, Stewart & Co., during the year 1889, placed two very powerful mineral engines upon the Barry Railway, the working of which has been carefully watched and proves highly satisfactory.

These engines run upon eight coupled wheels and have outside cylinders, and are of very considerable power.

Diameter of cylinders	20 ins.
Length of stroke	26 "
Eight coupled wheels	4 ft 3 "

Total wheel-base	15 ft. 5 ins.
The front axle has $\frac{1}{4}$ in. side play;	
The hind axle has $\frac{1}{4}$ in. side play; and	
The driving wheels are without flanges.	
Total heating surface	1,410 sq. ft.
Area of fire-grate	22.6 „
Weight of engine in working order without tender	49 tons.

From personal experience, the author can testify to the efficient manner in which these engines do their work, and it may be added that they are remarkably like the American well-known "Camel" class which for years has done such good work in America.

To Messrs. Sharp thus belongs the credit of introducing in this country the eight coupled engine with *outside* cylinders, and to Mr. F. W. Webb, of Crewe, in 1892, belongs the credit of introducing another eight coupled design having *inside* cylinders.

This new engine runs upon eight coupled wheels and has two inside cylinders. The boiler is of great length, being similar to that of "Greater Britain," illustrated Fig. 86, the tubes being divided into two lengths by a combustion chamber, those extending from the fire-box to the combustion chamber being 4 feet 10 inches long between tube plates, and those forming the front group being 8 feet 1 inch long between tube plates. The cylinders, which are inside, are $19\frac{1}{2}$ inches diameter by 24 inches stroke, the valves being on the top and worked with Joy's gear. The springs on the first three pairs of wheels are connected together by equalising links, the trailing pair having an ordinary cross spring. The leading and trailing wheels have $\frac{1}{2}$ inch side play, which gives greater facility for running round curves.

Below are given a few leading particulars:—

Cylinders—19½ in. diameter by 24 in. stroke.

				ft.	in.
Diameter of wheels with 3-in. tires	4	6½
Distance between centres of wheels	5	9
Total wheel base	17	3

Boiler—

Length of barrel	15	6
" fire-box casing	6	10
Diameter of barrel (mean)	4	3
Number of tubes—156					
Diameter of tubes	0	2½
Pressure of steam	160 lbs.	per sq. in.

Heating surface—

Fire-box	114·7	
Combustion chamber	39·1	
Tubes (front)	683	
Tubes (back)	408·5	
Total	1,245·3	sq. ft.

Grate area	20·5	sq. ft.
Ratio of fire-grate area to heating surface	1 to 60·6	

Weight of engine in working order—

				Tons.	cwts.	qrs.
Leading wheels	11	18	0
Driving	12	14	0
Intermediate	11	13	0
Trailing	10	16	3
Total	46	16	3

Weight of tender in working order, 25 tons.

The tractive co-efficient is 172. The leading and trailing wheels have a certain amount of side play, so as to give greater facility for running round curves, though the total wheel base is not more than other engines which have not the same side play. The coupling-rod from wheel to wheel is complete in itself, and all of them are so arranged as to be interchangeable. The driving-axle has two bearings as usual, nine inches long, and in addition a central

frame and central bearing to withstand the great stress placed upon it. The total bearing surface for the driving-axle is $23\frac{1}{2}$ square inches.

Engines with eight coupled wheels are, of course, very common in America, but Mr. Webb's new design is the first eight coupled with *inside* cylinders that has been built in this country, certainly during the past sixty years. The first of these powerful mineral engines is giving the greatest satisfaction on the London and North-Western Railway, and there is every reason to believe that it will continue to do so, as it has large cylinders, high steam pressure, and is non-compound. Mr. Webb has built other engines of the same pattern, but compound, in order to test the two designs in daily traffic. Both have given good results with trains of sixty waggons of coal.

CHAPTER VII.

NOTES ON AMERICAN ENGINES.

THE Exhibition at Chicago in 1893 not only formed the greatest collection of locomotives which had ever been made, but included examples of engines from which English engineers might learn some useful lessons. It will long be remembered in locomotive history on account of the very complete record—forming an exhibit as remarkable for its vast extent as for the interest of its details—which was placed in the Transportation Department of the Exhibition, showing the history and development of the locomotive, step by step, in every country in the world. Numerous modern engines were there as parts of the exhibit, while older and disused forms of the locomotive were represented either by full-sized models or by diagrams, of which there were a very great number. Some idea may be formed of the number of these diagrams when it is mentioned that the author, acting simply as a representative for Great Britain, was able to forward a collection of over one thousand photographs, working drawings, or other illustrations of engines constructed for railways in this country.

One interesting relic in the Exhibition was the old engine named "Stevens" when constructed, but

re-named "John Bull" immediately upon its arrival in America—which as long ago as 1831 was built by R. Stephenson & Co., of Newcastle-upon-Tyne, and forwarded to the Camden and Amboy Railroad. This old engine (Fig. 93) has been so well preserved that at the commencement of the Exhibition it ran in steam with its train from New York to Chicago, a distance of 913 miles.

Turning now to the engines in daily use in the United States, the first thing to strike the mind of



Fig. 93.—Stevens ("John Bull") as at Chicago Exhibition, 1893.

an Englishman is the immense size of the American engines, the great height to the top of the chimney, the height of the centre line of the boiler, and the diameter of the boiler, and the high pressure carried, usually 180 lbs. per square inch.

The standard American passenger engine has a leading bogie, four coupled wheels, outside cylinders, and the usual bar-framing—this is known as the "American Type," and is very clearly illustrated by the celebrated "999" (Nine-ninety-nine), Fig. 94.

No. "999" is one of the class designed by Mr. Buchanan, Locomotive Superintendent of the New York Central, and constructed at the West Albany shops of the Company for working the Empire State Express traffic, and the author is indebted to the officials for the photograph from which Fig. 94 is engraved, and also for the following details:—

No. 999.

Cylinders	19 in. × 24 in.
Diameter of driving-wheels outside of tires	7 ft. 2 in.
Diameter of engine truck wheels	40 in.
Springs, length of driver, centre to centre of hangers	44 in.
Total length of boiler	26 ft. × 4½ in.
Diameter of first ring outside	58 in.
Size of fire-box	108½ in. × 40½ in.
Tubes, 268	2 in. dia., 12 ft. long.
Heating surface in tubes	1,697.45 sq. ft.
" " " " fire-box	232.92 sq. ft.
Total heating surface	1,930.37 sq. ft.
Grate surface	30.7 sq. ft.
Stack, inside diameter	15½ in.
Weight in working order	124,000 lbs.
Weight on drivers	84,000 lbs.
Driving-wheel base	8 ft. 6 in.
Weight of tender loaded	80,000 lbs.
Total weight of engine and tender	204,000 lbs.
Total length of engine	39 ft. 6½ in.
Extreme height from rails to top of stack	14 ft. 10 in.
From rails to centre line of boiler	8 ft. 11½ in.
Boiler pressure	180 lbs. per sq. in.

The engine is fitted with the Westinghouse automatic quick-acting brake, and has brake blocks applied to every wheel, including the leading bogie.

For a long distance journey it is interesting to note the working of the Empire State express on the New

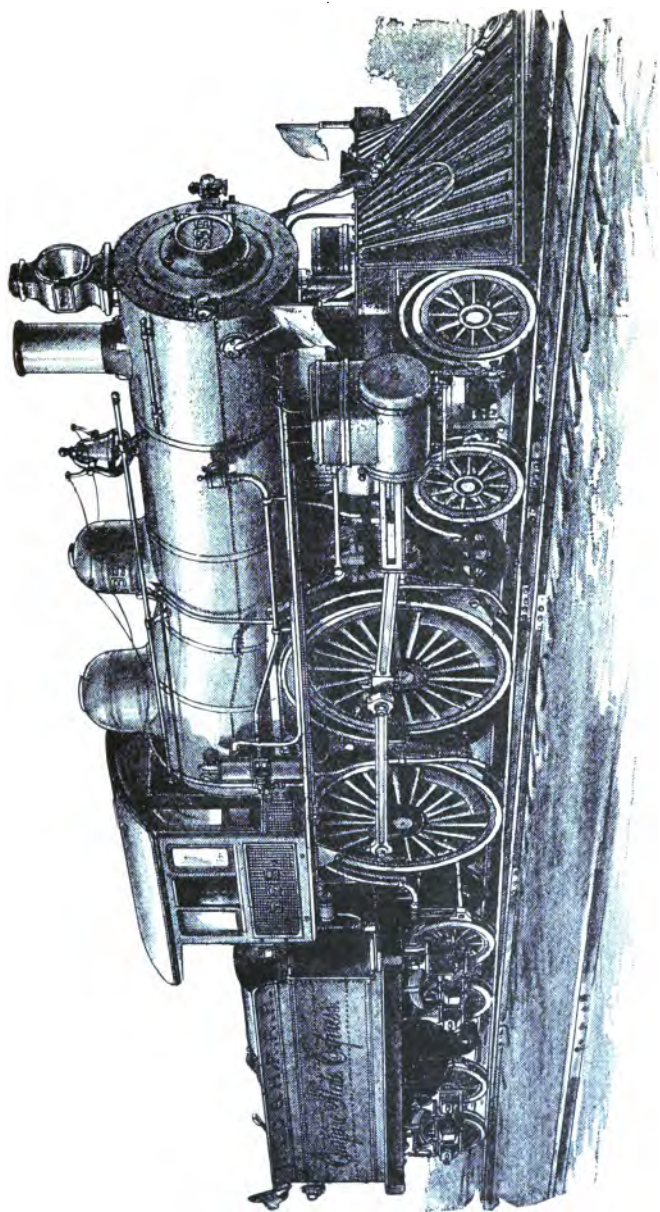

Fig. 94.—A Celebrated American Locomotive (New York Central), "999" (Nine-ninety-nine), 1893.

York Central road, which leaves New York at 8.30 A.M., and arrives at Buffalo at 5.10 P.M.—a distance of 440 miles in eight hours and forty minutes, including four stoppages. The same train makes the long run without a stop of 143 miles. Although extremely heavy, and requiring some very hard locomotive work, it was found by the author to keep most perfect time, covering many miles in exactly forty-four seconds each, and a speed of over eighty miles an hour was maintained for ten and twelve miles together, and the engine was not being forced to the top of its speed.

On the 11th September, 1895, in consequence of the fast running in England, a special express ran as follows:—

TIME OF THE RUN COMPILED FROM THE MINUTES OF THE OFFICIAL TIMEKEEPERS, MESSRS. ANGUS SINCLAIR, PROFESSOR P. H. DUDLEY, AND A. G. LEONARD.

New York to Albany.

	h.	m.	s.
Left New York, Grand Central Station..	5	40	30 A.M.
Arrived at Albany	7	54	55 ,,

143 miles in 134 min. 25 sec.—63·83 miles per hour. Stopped at Albany, changing engines, 1 min. 35 sec.

Albany to Syracuse.

	h.	m.	s.
Left Albany	7	56	45 A.M.
Arrived at Syracuse	10	17	10 ,,

148 miles in 140 min. 25 sec.—63·23 miles per hour. Stopped at Syracuse, changing engines, 2 min. 25 sec.

Syracuse to East Buffalo.

	h.	m.	s.
Left Syracuse	10	19	35 A.M.
Arrived at East Buffalo	12	32	26 P.M.

145½ miles in 132 min. 51 sec.—65·51 miles per hour.

436½ miles in 411 min. 41 sec., including two stops, 4 min.—63·61 miles per hour.

436½ miles in 407 min. 41 sec., exclusive of stops—64·24 miles per hour.

The train was made up of four cars, weighed 361,000 lbs. (including passengers and supplies), and had a carrying capacity of 218 passengers. Including the engine and tender, the train was 337 ft. long, and weighed 565,000 lbs. The engines used on this run were: New York to Albany, No. 870; Albany to Syracuse, No. 999; Syracuse to East Buffalo, No. 903.

When in America in 1893 the Author rode upon engines of the Philadelphia and Reading Railroad, built at the celebrated Baldwin Works. They are known as the "Double-ender type," from the fact that they have a pair of small wheels at each end of the frame; they are of the four-cylinder compound principle of Mr. Vauclain of the Baldwin Works, the high and low pressure cylinders being placed in pairs on each side of the engine, which is a very great advantage over the three-cylinder pattern of engine.

Atlantic City is, of course, as all the world knows, the seaside resort more especially of the inhabitants of Philadelphia, and is $55\frac{1}{2}$ miles distant from the Camden station of that city, and vast numbers of business men require to travel daily to Philadelphia and back. For their accommodation an express train leaves Atlantic City at 7.45 A.M., and is due at Camden in exactly an hour, and to return at 4.10 P.M., arriving back at the seaside at 5.10 P.M.

To start and stop, run $55\frac{1}{2}$ miles in one hour, and convey loads of either seven, eight, or nine heavy American cars completely filled with passengers is a kind of locomotive work not to be found in England; yet when riding on the engines the author timed ten

miles together at a speed of eighty miles an hour, and a few miles at 81·8 in the hour.

Ordinary passenger trains in our own country do not require the construction of engines with more than four coupled wheels. However, the steepness of gradient over many sections of American lines, together with the immense weight of train, renders it necessary to employ for some passenger trains vast engines having a four-wheeled leading bogie and six coupled wheels of 6 feet diameter. This being a development of locomotive power which the Author had not previously been able to personally examine, it naturally engaged his careful attention, and he was glad to have the opportunity, when visiting the celebrated Baldwin Works, of observing several of the engines in course of construction. He was able also to watch their working when travelling on the foot-plate.

When visiting the shops of the Pennsylvania Railroad at Altoona, in 1893, the Author witnessed the commencement of six large express engines known as design P, No. 1,659 class. They have a leading bogie, four coupled wheels of 6 feet 6 inches in diameter, cylinders 19 inches \times 24 inches (placed outside), and a boiler pressure of 175 lbs. per square inch. The boiler is no less than 4 feet 9 inches in diameter, and the height of the engine from the rail to top of chimney is 15 feet.

Since that time still larger engines have been built with 7-foot wheels and 180 lbs. pressure. It is not surprising to learn that engines of such size and power are working the Pennsylvania Company's heaviest and fastest trains between New York, Philadelphia, and Pittsburg with great success.

The latest American design is No. 385, Philadelphia and Reading Railroad, built at the Baldwin Works, Fig. 95.

The engine is a "Vauclain" four-cylinder compound, having a "single" pair of 7-foot driving wheels. Diameter of high-pressure cylinders, 13 in.; diameter of low-pressure cylinders, 22 in.; stroke of both pistons, 26 in. Working pressure of steam, 200 lb. per square inch. The weight on the driving wheels is about 24 tons.

With trains of 430 tons this engine has run a mile in forty-five seconds, and with a lighter load a speed of eighty-five miles an hour has been attained. The height of the engine from the rail to the top of the chimney is 15 feet.

The line between Philadelphia and Jersey City is now laid with rails of 90 and 100 lb. to the yard, and most of them are 60 feet in length. With such a good road there is, of course, no objection to the great weights being now placed on single-drivers, which a few years ago would have broken up the track.

From an official report lately received it is shown that the engine No. 385 was finished at the celebrated Baldwin Works on the 3rd of July last, and on the next day it ran an experimental trip to Reading, a distance of sixty miles, and return, the train being a light one. As everything appeared to be running cool and smoothly, the engine was immediately put into the fastest express service, and on 5th July ran the Royal Blue Line trains, Philadelphia to Jersey City, New York, a distance of ninety miles. From that day to the present the engine has not missed a trip. She burns four tons (2,000 lbs. to the ton) of small

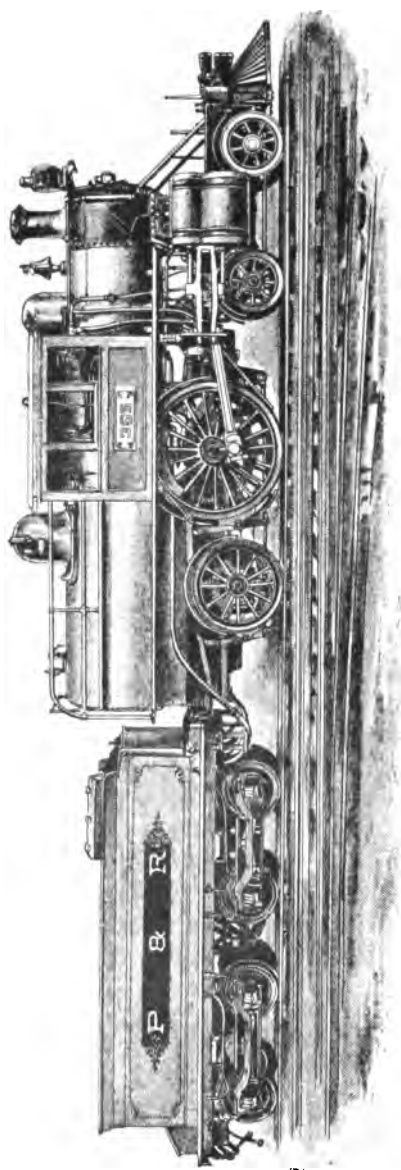

Fig. 95 — American Express Engine, Philadelphia and Reading Railroad, 1895.

anthracite coal, which costs about 2s. 8½d. per ton at the pits.

An official report recently received states that engine No. 385 has a total mileage to March 31st, 1896, of 41,532 miles. Fuel consumed, anthracite buckwheat coal, 1423 tons. Weight of train east-bound, 346,800 lbs.; weight of train west-bound, 290,550 lbs. While the average speed of this train is about 48 miles per hour, we have the greater part of this distance maintained at a speed greater than 60 miles an hour.

Another engine of the same design, No. 378, has been constructed at the Baldwin Works for the same Company, and is now in service.

In concluding this chapter the Author may remark that it is almost certain his readers will wish for an answer to the question: "How is it, or what is the reason, that these American engines can do the work and convey the loads which they do?" He can, in reply, from his own experience of riding upon the foot-plates for about a thousand miles, express the opinion that the successful working of the American engines is due to the large fire-boxes, immense boilers, high pressure of steam, and large valves, and consequently free exhaust; and it is, in his opinion, to be hoped that English engineers will in their new designs do their best to incorporate these good features in the locomotives of this country.

CHAPTER VIII.

IMPORTANT LINKS IN LOCOMOTIVE HISTORY.

As already mentioned in previous chapters, the Chicago Exhibition of 1893, followed by recent discussions in the engineering and mechanical journals, have brought to light many important links in locomotive history which were forgotten, and have finally settled a number of points which for years past have been regarded as doubtful.

It is not proposed to discuss the subjects here, in the small space available, but simply to record matters of importance.

The invention of the "bogie," for instance, has been investigated, and it is found that in the year 1815 "Puffing Billy" ran on two four-wheeled bogies as shown in Fig. 8 (p. 17). In August, 1832, Mr. John B. Jervis, the engineer of the Mohawk and Hudson Railroad, had an engine built in America for that line, named "Experiment." It had a regular "four-wheeled" leading bogie placed under the smoke-box, and a single pair of driving wheels placed at the trailing end, and was without doubt the forerunner of all the bogie passenger engines of to-day.

The "bar-framing," which is generally used in the United States, has by some persons been considered as an American invention, and others have considered that it was introduced by Bury. The Delaware and

Hudson Canal Company's diagram, shown at the Chicago Exhibition, proved that the "bar-frame" was sent to America early in the year 1828, by Stephenson and Co., of Newcastle, as illustrated, Fig. 14 of this volume.

The question, Which was the first inside cylinder engine? is another point which has been fully investigated, and Mr. James Dredge, in his splendid book, "Transportation Exhibits at Chicago," states that "the 'Planet' of 1830 has the undoubted honour of being the first inside cylinder engine." This completely confirms the opinion of the Author already expressed in this volume (p. 38).

The descendants of Mr. Edward Bury, of Liverpool, have produced books and drawings which make the history of the engines built by that firm very clear. The first engine built by him at Clarence Foundry was an outside cylinder engine, the "Dreadnaught," which was completed March, 1830, but proved a failure. However, he lost no time, but with the assistance of his foreman, Mr. Kennedy, got out working drawings for a new engine to be named the "Liverpool." This engine, No. 2 in the locomotive order book, and "Class A" in the description book, was commenced early in January, 1831; it was completed in March of that year; and in May, 1831, it was put to work on the Petersburg Railroad of America. It is illustrated in Fig. 96 It had four coupled wheels of 4 ft. 6 in. diameter.

The third engine built by Mr. Bury—the "Liver" (No. 3 in the order book, and "B" in the description book)—was for working passenger traffic upon the Liverpool and Manchester Railway. It had a single

pair of driving wheels 5 ft. in diameter. It was put to work at Edge Hill in February, 1832, and in the

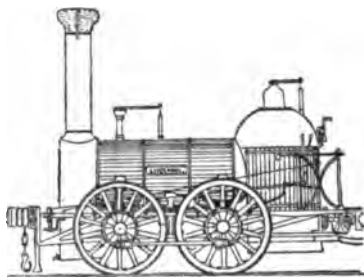

Fig. 96. —Bury's first Inside-cylinder Engine, "Liverpool," completed March, 1831; sent to America.

forty-three weeks in the year 1832 it ran 22,651 miles, followed by 23,134 miles in the year 1833. The official drawing of this engine is reproduced in Fig. 97.

There is no doubt that the "link motion" was a

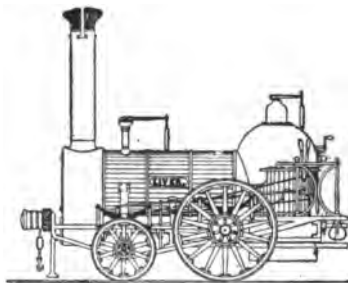

Fig. 97. —Bury's first Passenger Engine, "Liver," completed February, 1832. Liverpool and Manchester Railway.

separate invention in England in 1842, and that (as stated at p. 88) it was introduced by William Howe, and

fitted to the North Midland Company's engine, No. 71. On the other hand, it is now equally certain that the "James," designed and built by W. T. James, of New York, was the first locomotive in the world fitted with the link motion. It had a vertical boiler, four wheels (not coupled), and inclined cylinders driving a spur wheel shaft directly above the driving axle, and was

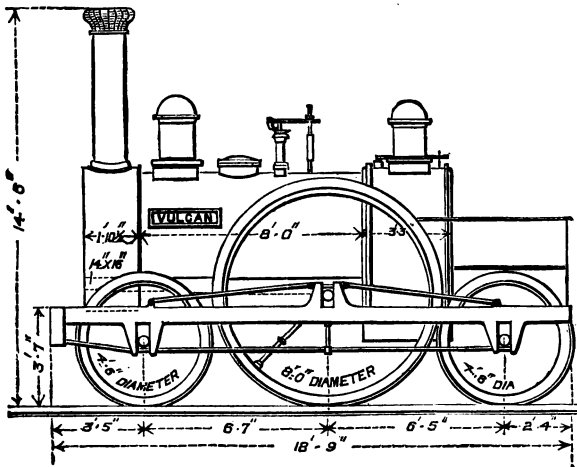

Fig. 98.—"Vulcan," 1837. Charles Tayleur & Co.
Great Western Railway, No. 2.

constructed in 1832, or ten years before the English invention.

Very considerable attention has recently been given in the mechanical journals to the early history of the Great Western Company's broad gauge engines, and it is a fortunate circumstance that this Company possesses a most complete record of details and drawings. The official list of the first twenty engines is

reproduced in a folding sheet facing p. 73, and the "North Star" is illustrated, Fig. 44.

The old official working drawings of the other engines have lately been published in the *Engineer*, and by the courtesy of the editor of that journal are reproduced here.

The "Vulcan" (Fig. 98) was from the works of Chas.

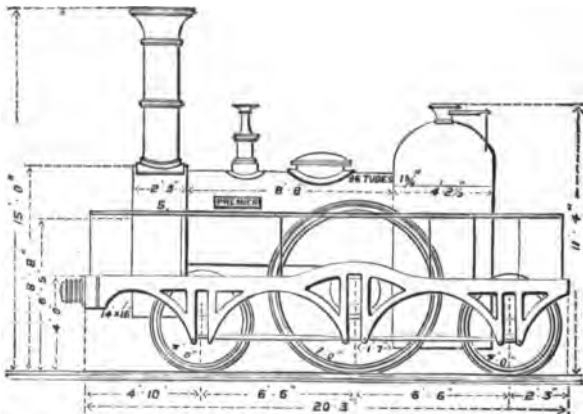

Fig. 99.—"Premier," 1838. Built by Mather, Dixon & Co. Great Western Railway, No. 5.

Taylor and Co., of the Vulcan Foundry, and may be taken as representing the six engines built for the Great Western Railway Company by this firm.

The "Premier" was built by Mather, Dixon, and Co., and had driving-wheels of 7 feet diameter (see Fig. 99).

The "Lion" and its two fellow engines were very similar in design and construction to "Sharp's Standard," already shown in Fig. 43.

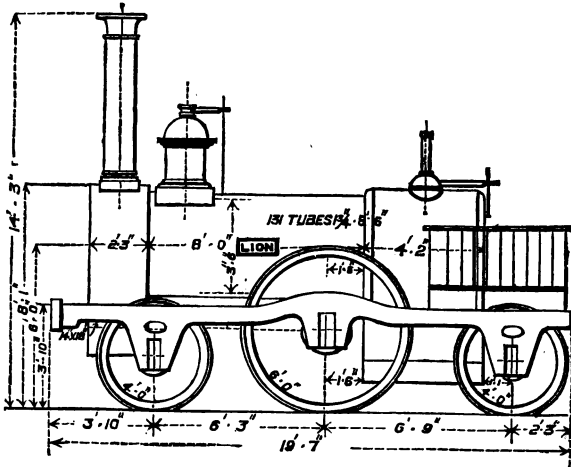

Fig. 100 — "Lion," 1838. Sharp, Roberts & Co.
Great Western Railway, No. 7.

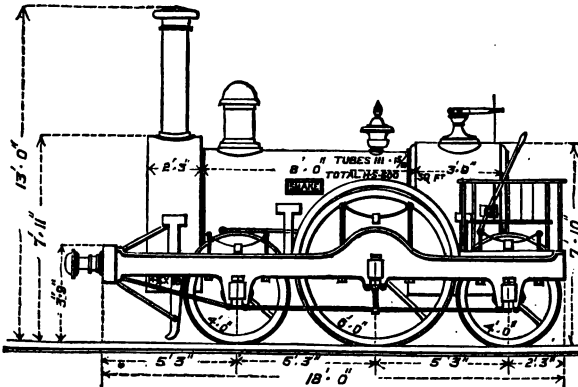

Fig. 101. — "Snake," Haigh Foundry Co., 1838.
Great Western Railway, No. 13.

Two engines, the "Snake" and the "Viper," were constructed by the Haigh Foundry Company. They were ordinary engines, and constructed to the firm's standard patterns. They also had the makers' well-known "Haigh Foundry valve gear." (See Figs. 100, 101.)

The "Ajax" (Fig. 102) was built by Mather, Dixon & Co., and had driving wheels of 8 feet diameter, but they were of the very peculiar construction shown in Fig. 103.

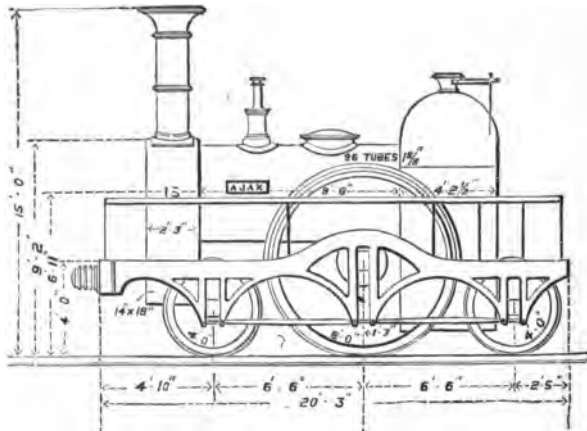

Fig. 102.—"Ajax," 1838. Mather, Dixon & Co.
Great Western Railway, No. 15.

These wheels had no spokes whatever, but consisted of two discs of iron plate stayed together in a manner very similar to the staying of a fire-box.

Then followed two extraordinary engines constructed upon the patent of Mr. T. E. Harrison, which have been already described at page 76. One of them, the "Hurricane," is illustrated in Fig. 46. They both proved failures, and they neither of them ever worked a regular train. (See also list facing p. 73.)

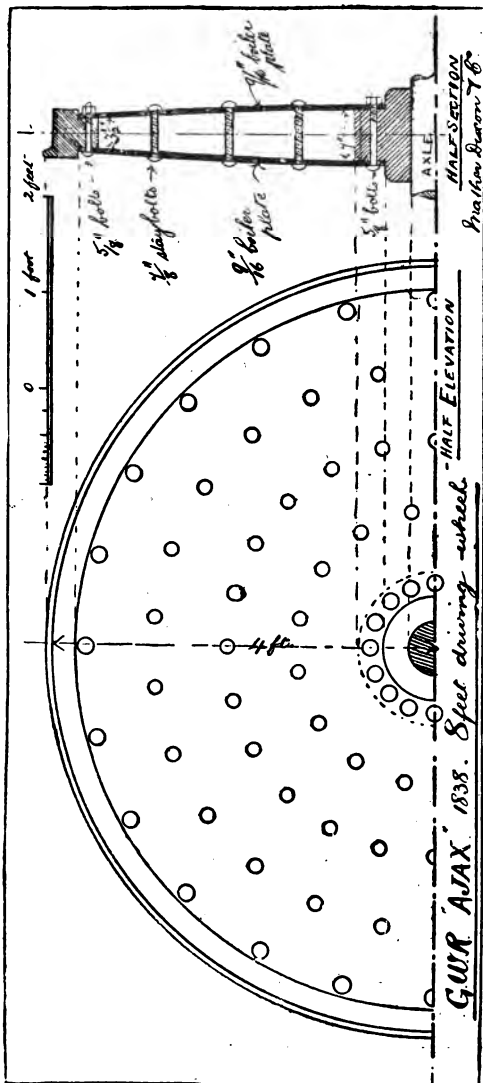

Fig. 103.—"AJAX" Wheel, Mather, Dixon & Co., for the Great Western Railway, 1838.

Attention has been directed in the newspapers to the engines having 10 feet wheels, and also to those "geared up." Investigation has proved that the "Thunderer" was the only "geared" engine, and that the "Hurricane" was the *only* one on the Great Western with 10 feet wheels. This latter engine was altered several times, and was known also as "Grasshopper" and "Ajax," which fully accounts for the incorrect report that three engines—"Hurricane," "Grasshopper," and "Ajax"—all had 10 feet wheels, the fact being that it was one and the same engine (see Fig. 46, page 76).

A comparison of Figs. Nos. 46 and 104 will show that the boilers of the "Thunderer" and "Hurricane" were similar, but that the engines were of very different construction.

In 1840, the first of the broad gauge 7-foot driving-wheel engines, built to the designs of Mr. Gooch, were delivered to the company, and during 1840, 1841, and 1842 no less than 62 engines of this design, Fig. 105, were constructed. Messrs. Sharp, Roberts, & Co. supplied 10; Fenton, Murray, & Jackson 20; Longridge & Co. 6; Nasmyth & Co. 16; Slaughter & Co. 2; Jones, Turner, & Evans 6; and Messrs. Rennie & Co. 2. The dimensions were, driving-wheels 7 feet, cylinders 15 by 18, weight in working order 24 tons 4 cwts.

Fig. 106 illustrates an engine of the Great Western Company's, the "Leopard," which was built in 1840, and exploded in 1857. It should, however, be mentioned that the accident was not due to any defect in the boiler, but to the safety-valve, from some cause, allowing too high a pressure. The illustration is of

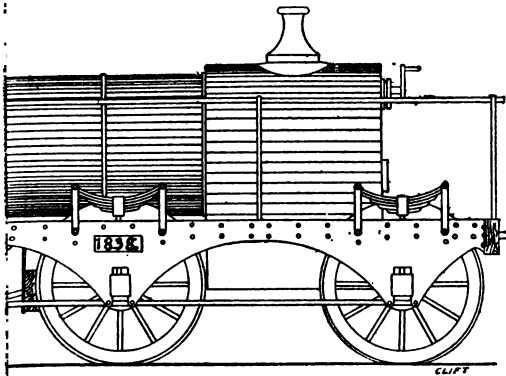

...n for the Great Western Railway, 1838.

[To face p. 206.]

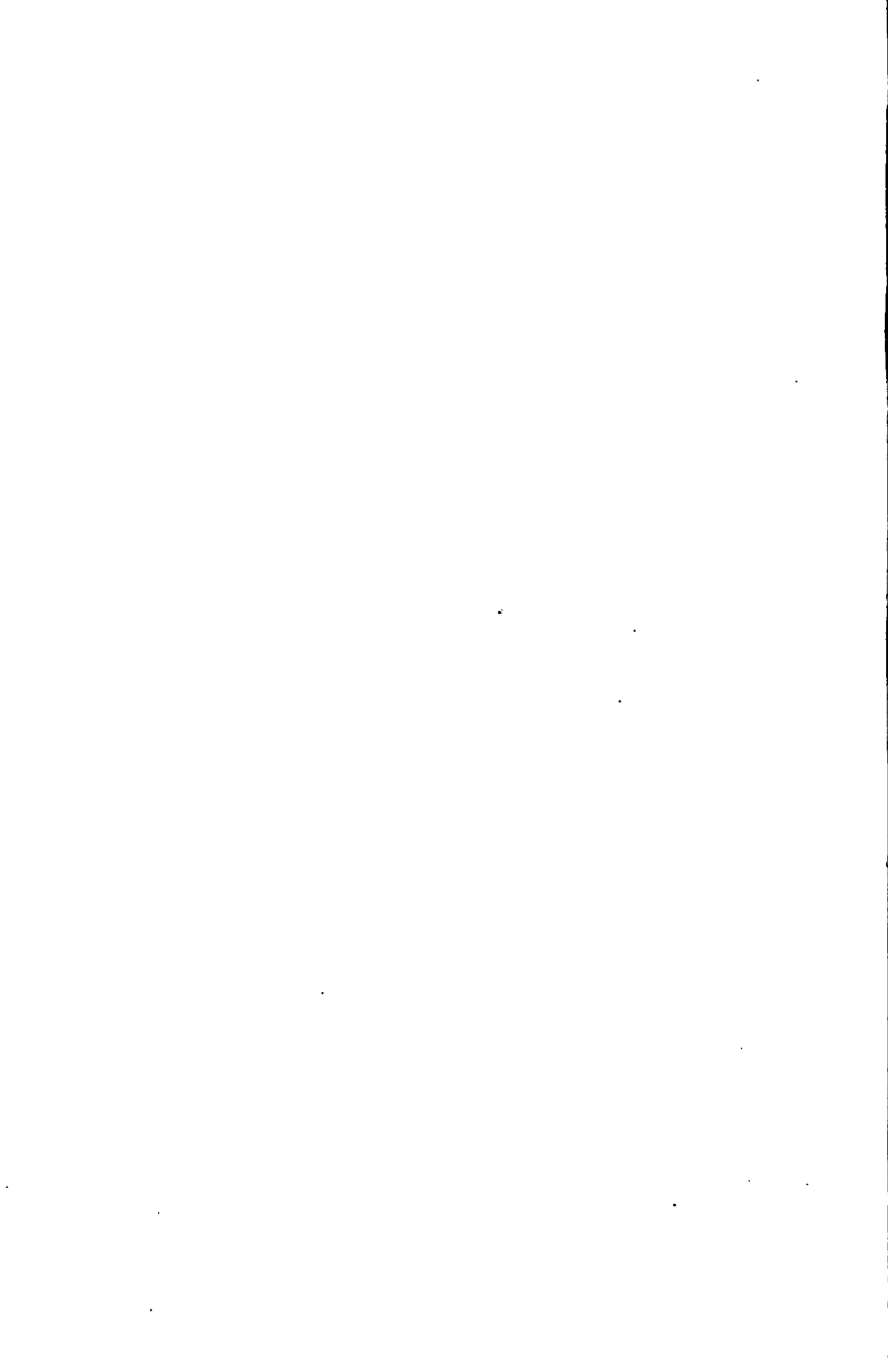

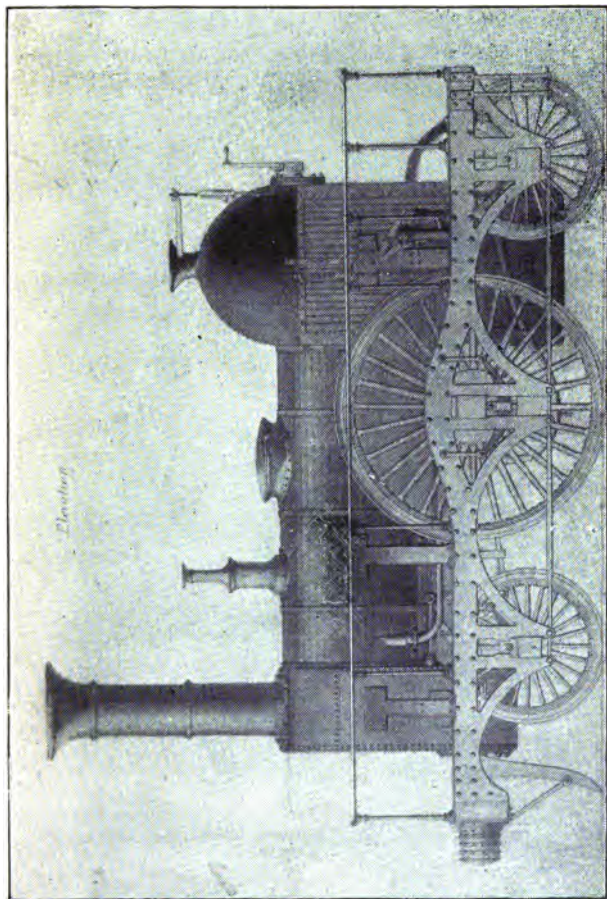

Fig. 105.—Mr. Gooch's Design of Passenger Engine for the Great Western Railway, 1840.

interest as showing the pattern of framing and high dome fire-box casing which was used in 1840.

Between the years 1847 and 1855 Mr. Gooch placed

twenty-nine engines of the eight-wheeled type upon the line, the names of which are given in the list on page 96, and the design whereof is clearly shown in Fig. 107.

The first engine of the type was named the "Iron Duke," built at Swindon, April, 1847, but the "Lord of the Isles," sent to the Exhibition of 1851, became so



Fig. 106.—"Leopard," from a photograph taken after an explosion in 1857.

well known, that the general public, to a considerable extent, speak of the class as the "Lord of the Isles type."

At the time when the broad gauge was finally abandoned, in 1892, many of the newspapers made reference to the "fine old engines which had run over 40 years." This was known to be an error, as the

Company had built entirely new engines to take the place of the originals. For instance, the "Great Western" was built in 1846 as a six-wheeled engine,

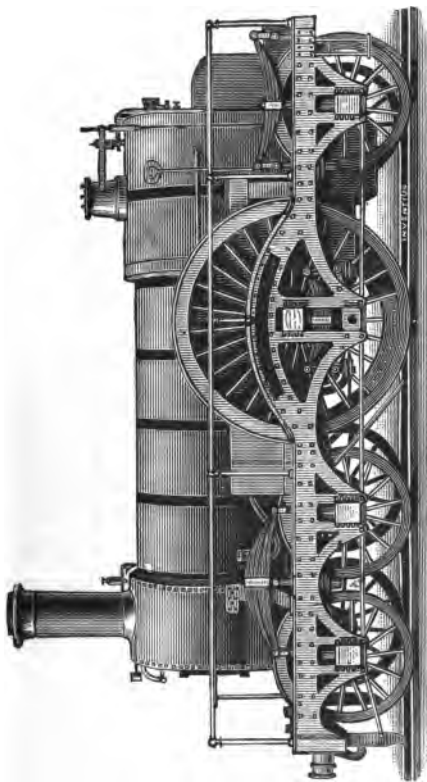

Fig. 107.—Great Western Company's Engines, "Iron Duke" or "Lord of the Isles" class, built at Swindon between 1847 and 1855.

but was converted to eight wheels, and ran in that state until 1870 (see Fig. 54, p. 95). An entirely new "Great Western" was built in 1888, and ran until

23rd May, 1892. This fact was conclusively proved at the Chicago Exhibition, as the two official drawings—one of 1846, and the other of 1888—were framed and placed side by side: and in a similar way many other engines, which have been regarded as *old*, were perfectly new, and simply bore the name of the former engines.

In July, 1846, the London and Birmingham Railway Company ceased to exist, and the new London and North Western Company's directors ordered that Bury's four-wheeled engines were not to be employed on the express trains between London and Rugby and Birmingham, and that a number of six or eight-wheeled engines should be immediately constructed for their line.

Mr. Bury held the strongest views in favour of his four-wheeled engines, and firmly refused to carry out the orders of the directors. Twenty-four hours settled the question. Mr. Bury had to "go," and Mr. McConnell was brought from Bromsgrove, and installed as Locomotive Superintendent of the Southern Division of the London and North Western Railway at Wolverton Works, towards the close of the year 1846. Acting under the instructions of the directors he ordered locomotives from a number of the leading makers; each maker to supply his own best design of engines, and Wolverton Works was fully occupied in converting Bury's engines and adding an extra pair of wheels behind the fire-box.

Very soon Mr. McConnell had under his control the well-known engines by Sharp, E. B. Wilson, Hawthorn, Haigh Foundry Company, Tayleur of Vulcan Foundry, and Stephenson's long boiler engines of two patterns, namely, six wheels and eight wheels.

In practice it was soon found that all these various designs were inconvenient, as the parts were not interchangeable, and engines were often obliged to stand in the sheds for days or weeks out of service, pending some particular part being obtained from the makers. At the close of the year 1848 the directors decided that in future all engines required for the Southern Division should be built to the designs and dimensions of the Company, and Mr. McConnell was instructed to get out complete sets of drawings for "standard" engines, namely, two sizes of passenger engines, and one goods engine. Mr. McConnell found that the two engines which he had previously altered for the Birmingham and Gloucester Railway gave very excellent results; he therefore decided that Southern Division passenger engines should be upon that model. The first engine of the class was built at Wolverton, it was completed in December, 1849, but does not appear to have actually been put in service till January, 1850. This was the first of the "Bloomer" type to which reference has been made, page 105. It had cylinders 15 inches by 22 inches, and a single pair of driving-wheels 6 feet 6 inches in diameter, an inside frame and inside bearings only; the top of the chimney was copper, the dome-cover, safety-valve cover, and rim round the driving-wheel splasher of polished brass. The engine and tender were painted green; it was the forerunner of a large number of the class, and proved so satisfactory that orders were given to Messrs. Sharp for ten, Nos. 247 to 256. They had driving-wheels 7 feet diameter, and cylinders 16 inches by 22 inches. They commenced work in 1851.

In May, 1848, an important series of experiments

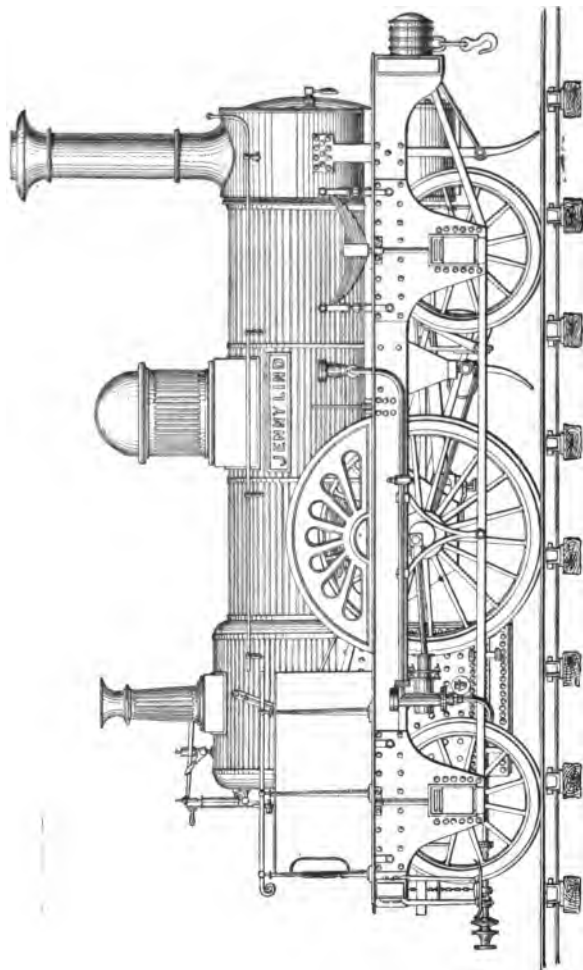

Fig. 108.—“Jenny Lind.” By E. B. Wilson & Co., for the London and Brighton Railway, May, 1847.

took place on the Midland Railway between Derby and Masborough, between two of Wilson's engines, Nos. 26 and 27, which in every respect were similar to Fig. 108, and two of Sharp's engines, Nos. 60 and 61, Fig. 109.

The diagram, Fig. 109, is taken from a drawing

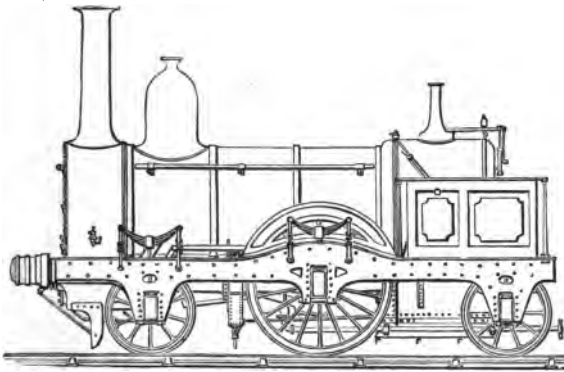

Fig. 109.—Midland Railway. No. 60, built April, 1848, by Sharp Brothers (for details see p. 103).

made by the author, when an engineering pupil, and shortly before the engine was broken up in 1870.

Mr. McConnell, having carefully examined all the locomotives at the Exhibition of 1851, early in 1852 considered that a larger engine was required on the Southern Division of the London and North Western, and he designed a class having double frames, driving wheels 7 feet 6 inches diameter, cylinders 18 inches by 24 inches. The first of these, No. 300, was placed on the line in November, 1852, having been constructed by Fairbairn & Sons. This engine is illustrated, Fig.

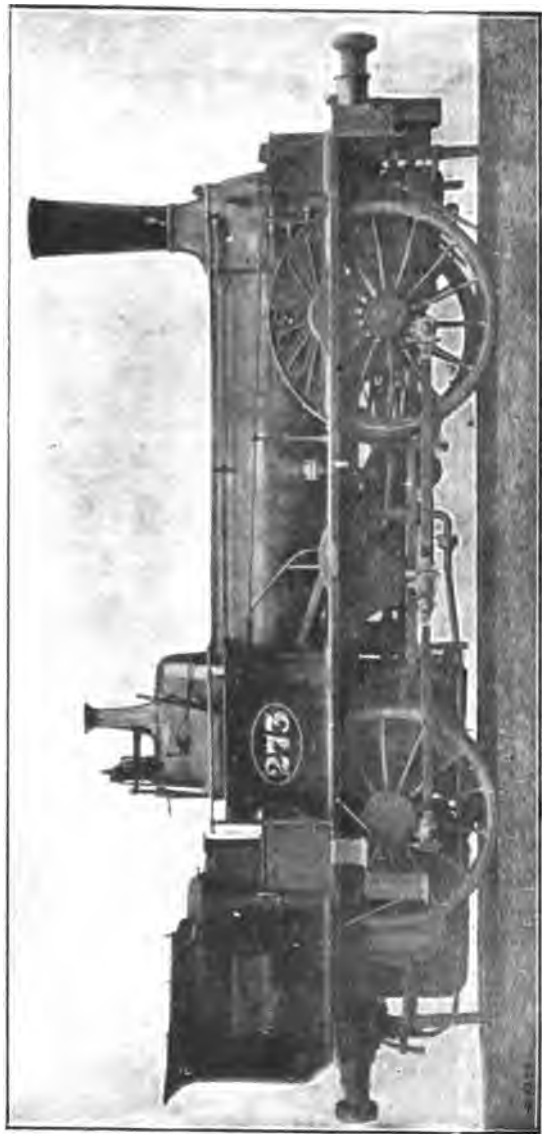

Fig. 110.—York, Newcastle, and Berwick Railway (Now N. E. R.) Tank Engine, with intermediate shaft. Designed by T. K. Crampton, 1847.

[For details see p. 98.]

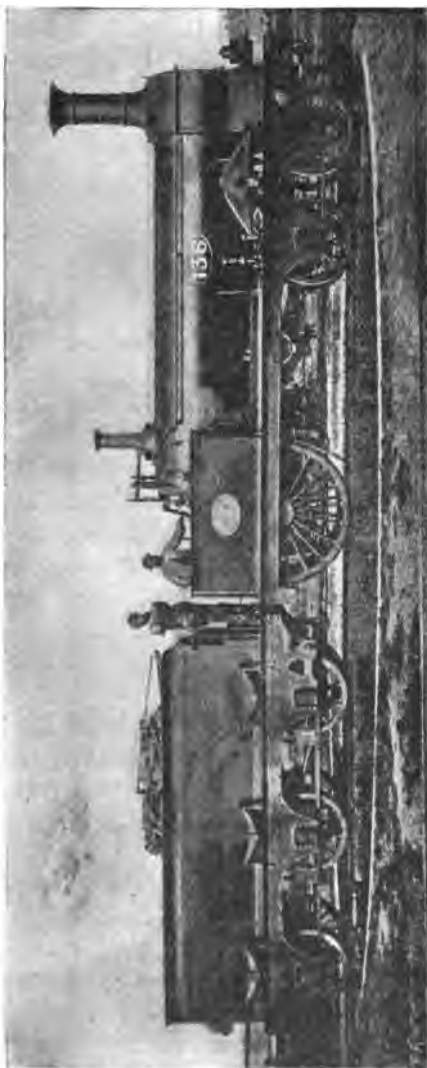

Fig. 111.—Crampton's Design.—"Folkestone" type. Tried on the Great Northern, South-Eastern, and London, Chatham, and Dover Railway.

[For details see p. 103.]

112, being a reproduction from the only drawing of this engine known to exist, and the presence of the men considerably disfigure it.

The brass plate on the side of the hand-rail bore the words:—

L. & N. W. RAILWAY,

WOLVERTON.

300,

McCONNELL'S PATENT.

MANUFACTURED BY

W. FAIRBAIRN & SONS, MANCHESTER, Nov., 1852.

This engine had McConnell's patent fire-box and boiler, which consisted of a mid-feather in the fire-box, a combustion chamber, a superheating vessel in the smoke-box through which steam passed from the boiler to the cylinders, and india-rubber springs; the tender also had an outside frame and india-rubber springs.

The question will be asked, how it was that Mr. McConnell, who was always such a strong advocate of the inside frame and inside bearings, should have designed the 300 class with double frames. There is no official information to supply the answer, but it has been generally understood that he employed the outside frame at the wish of the locomotive committee, who appeared to regard four bearings for large wheels as safer than two.

Upon page 107 of this volume details are given of the large eight-wheeled engine, No. 215 (shown in Fig. 114), designed by Mr. Sturrock, for the Great Northern Railway. When new this engine worked very unsatisfactorily, as it could not pass round curves easily; the four front wheels were taken out and placed in a



McConnell. Built by Fairbairn
(Particulars see pp. 105 and 213.)

[To face p. 216.

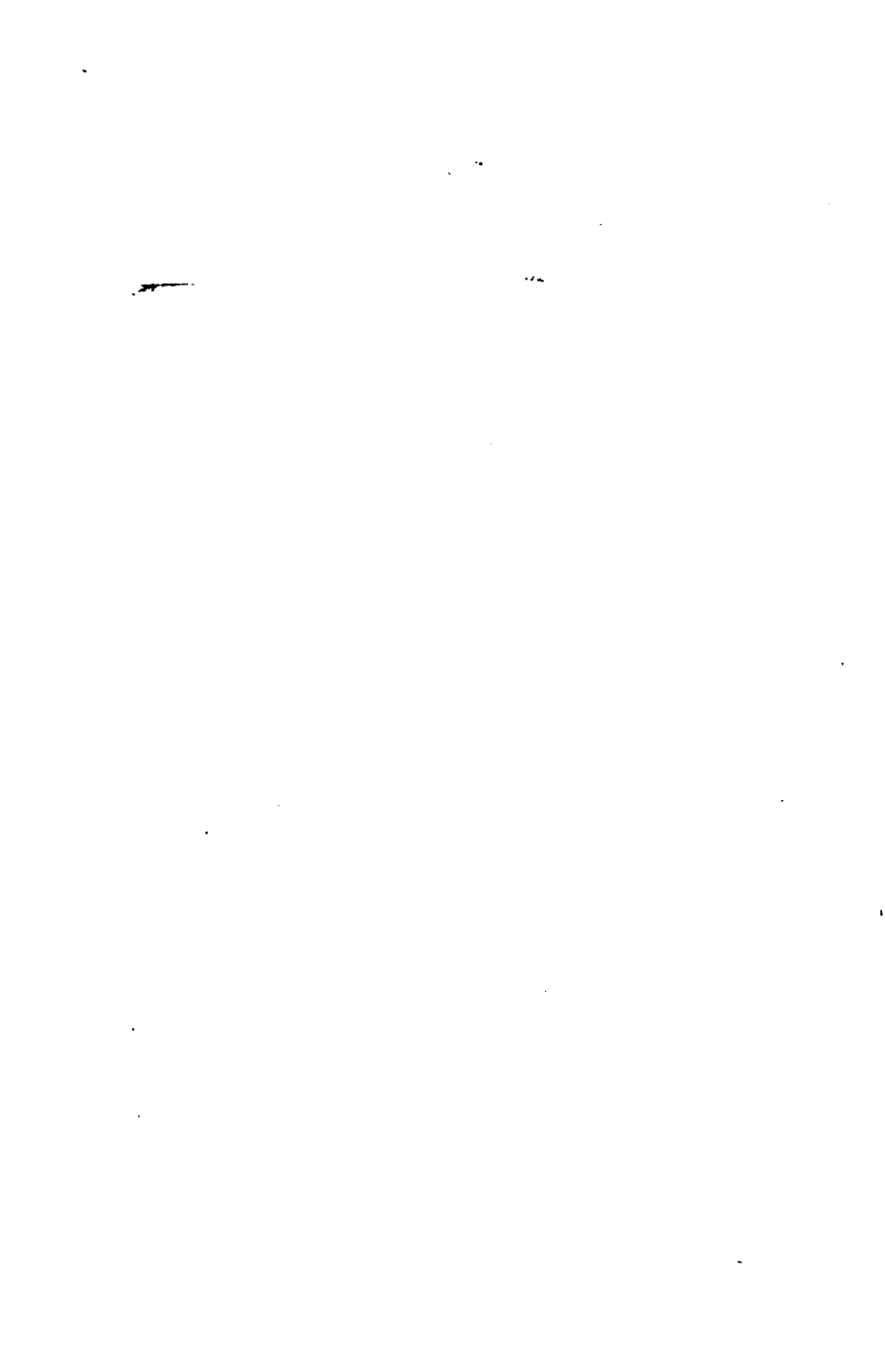

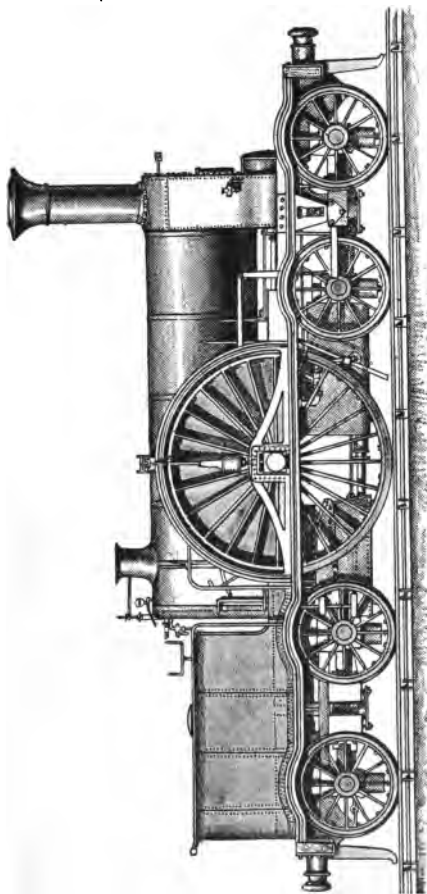

Fig. 113.—Bristol and Exeter Railway. Mr. Pearson's Tank Engine, 1853. Gauge 7 feet; driving-wheels 9 feet diameter (for details see p. 107).

“bogie,” and it ran till 1870, but no other engine of the same pattern was ever tried.

The McConnell engine, No. 373, Fig. 115, had Krupp’s steel axles and steel tyres. The pistons were of solid wrought iron, with two small brass packing-rings, kept tight by the pressure of steam admitted



Fig. 114.—Great Northern Railway, No. 215. As built by Hawthorn & Co., August, 1853.

behind them. The boiler was supplied by a pair of Giffard’s injectors. This engine had McConnell’s patent fire-box and boiler, and was provided with air tubes through the front and sides of the fire-box to assist in the combustion of smoke; it also had the usual copper top to the chimney, and brass dome; but in

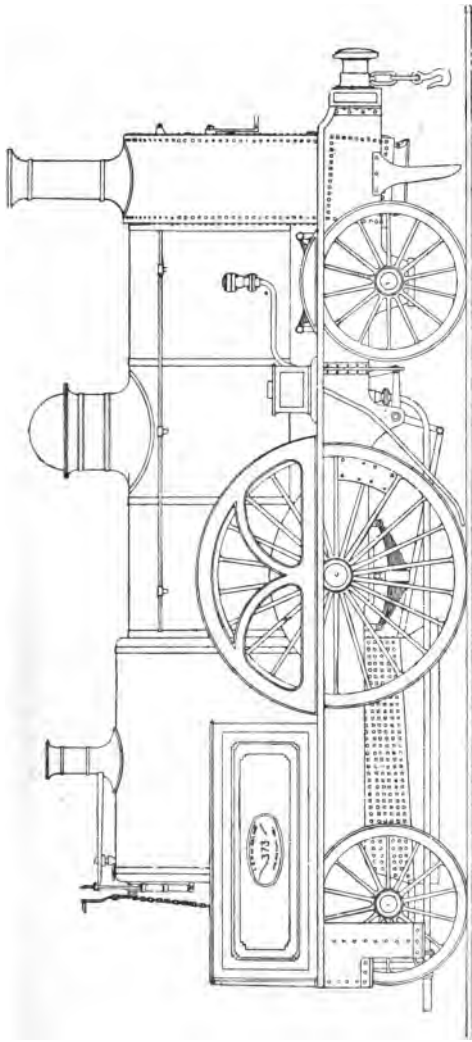

Fig. 115.—London and North-Western Railway, Southern Division, No. 373. Designed by Mr. McConnell. Built at Wolverton 1861. Sent to the Exhibition of 1862. Cylinders 18 by 24, Driving-Wheels 7 ft. 7½ in. (For details see p. 111.)

1862 the chimney-tops and domes of all the McConnell engines were painted over to save the trouble of cleaning. The tender ran on six wheels and weighed, loaded, 25 tons. None of the Southern Division engines appear to have been "rebuilt," but as the boilers became worn out the engines were broken up. However, the 373 class will always be remembered amongst the finest locomotives that ever ran on the London and North Western Railway. In 1861 Mr. McConnell resigned, and when Wolverton was closed as a locomotive establishment, the Southern Division engines had their numbers increased by 600, No. 1 becoming 601, and 373 being changed to 973, and the names "Delamere," "Caithness," and "Maberley" were given to the three engines by Mr. Ramsbottom, when they came under his charge. At a later date the numbers of these engines were again altered, and they ran for some years as 1,198, 1,199, and 1,200.

At the Exhibition of 1862 No. 373 received very great attention; but there was not then the weight of train to require engines of such power, and a smaller and lighter engine did the work quite as well, and at less cost. Thirty years ago one often saw great engines of the 373 type which were capable of working fully 30 or 35 of the old small coaches, running with light trains of 7 or 8 vehicles.

Fig. 116 illustrates one of Mr. Sturrock's steam tender engines, built by E. B. Wilson and Co. for the Great Northern Railway. *Mechanically* the steam tenders worked very well and conveyed 70 and 80 loads of coal, but as the lie-by sidings could only hold trains of 50 waggons, delays were caused to passenger trains, and practically Mr. Sturrock's system was a serious failure, and did not pay.

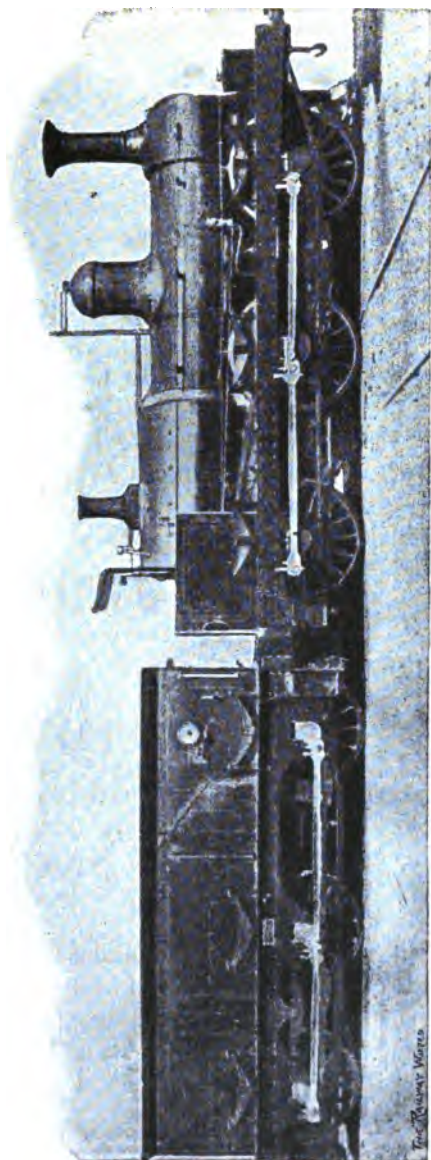

Fig. 116.—Great Northern Railway. Steam Tenders, designed by Mr. Sturrock.

[For details see p. 113.]

CHAPTER IX.

RECENT LOCOMOTIVE PRACTICE.

THERE are so very few instances in which passenger engines are owned and maintained for private use, that the new locomotive lately constructed by Messrs. Sharp, Stewart & Co., at the Atlas Works, Glasgow, to the designs of Mr. David Jones, the Locomotive Superintendent of the Highland Railway, for the Duke of Sutherland, deserves attention here.

The engine, "Dunrobin" (Fig. 117), is used for the purpose of working special trips as required, between the private station at Dunrobin Castle and Inverness; the engine and saloon of the Duke of Sutherland having running powers over that portion of the Highland Railway Company's system.

The "Dunrobin" has four coupled wheels and a trailing bogie. The cylinders are 13 inches, the stroke 18 inches; coupled wheels 4 feet 6 inches diameter; heating surface 575 square feet, and the weight in working order 31 tons 4 cwts.

The engine is fitted with the automatic vacuum brake, and has a very roomy cab, provided with seats and side-glazed shutters. There can be no doubt that the engine affords the most comfortable accommodation for passengers that can be found on any locomotive in use in this country.



the Duke of Sutherland.

[To face p. 222.]



The saloon is a fine example of the carriage-builder's skill, and includes everything necessary to make railway travelling an unquestioned luxury. The exterior of the carriage is painted in white and green with ornamentation in gold. At the rear are apartments for servants and a compartment for the guard.

The engine is always kept in readiness at Dunrobin.

The express engines in use upon the Manchester, Sheffield, and Lincolnshire Railway (Fig. 118) were designed by Mr. Harry Pollitt in 1895 to work the through trains to London upon the opening of the Company's (now the Great Central), main line being previously used to work the express trains between Manchester and Grantham.

The four-wheeled bogie, besides the circular movement, has $1\frac{1}{4}$ inch lateral play on each side.

The bogie wheels are 3 feet 6 inches diameter on the tread, 5 feet 9 inches centre to centre.

The capacity of the engines for work is shown at a glance by the following figures:—

Diameter of cylinders	18½ ins.
Length of stroke	26 ins.
Diameter of coupled wheels	7 ft.
Pressure of steam	170 lbs.

The boiler and fire-box casing are of Siemens-Martin steel, the fire-box is of the Belpaire pattern, which has been adopted by the Company as its standard. The fire-box and also the tubes are of copper, the tubes being 233 in number and $1\frac{1}{2}$ inches diameter outside.

Heating surface of tubes	1,209 sq. ft.
Heating surface of fire-box	109 " "
				<hr/>
				1,318 " "

The area of the fire-grate is 20 square feet, and the ratio of grate area to heating surface is 1 to 65·9.

The frames are of Siemens-Martin steel. The engine is fitted with Timmis' bearing springs, and Spencer Moulton's assistant springs under the driving and trailing axle-boxes; the foot-plate fittings include one No. 8 and one No. 9 Gresham and Craven's injector, the steam sand-blast, two sets of gauge-glasses, with Wall's gauges-glass protectors, also a perforated shield round the fire-box door, also the automatic vacuum brake.

The connection between the engine and tender is not made by side buffers, but a large central spring is employed, which most effectually prevents any loose or jerky motion between engine and tender. The tender runs on six wheels, and carries 4,000 gallons of water and 5 tons of coal. The weight in working order is—

					tons.	cwts.
On bogie wheels	15	9
On driving-wheels	16	7
On trailing-wheels	15	2
					<hr/>	
Total engine	46	18
Weight of tender	40	10
					<hr/>	
Grand total engine and tender	87	8

Thirty-six of these engines have been ordered; at the time of writing twelve are running and the others are under construction at the Company's works at Gorton. The author having ridden with these engines, can speak of the satisfactory manner in which they are working.

It is very unusual in this country to find express engines with driving-wheels of less than 6 feet diameter, but the extremely severe gradients over which



ent Central) Railway.

[To face p. 221.]

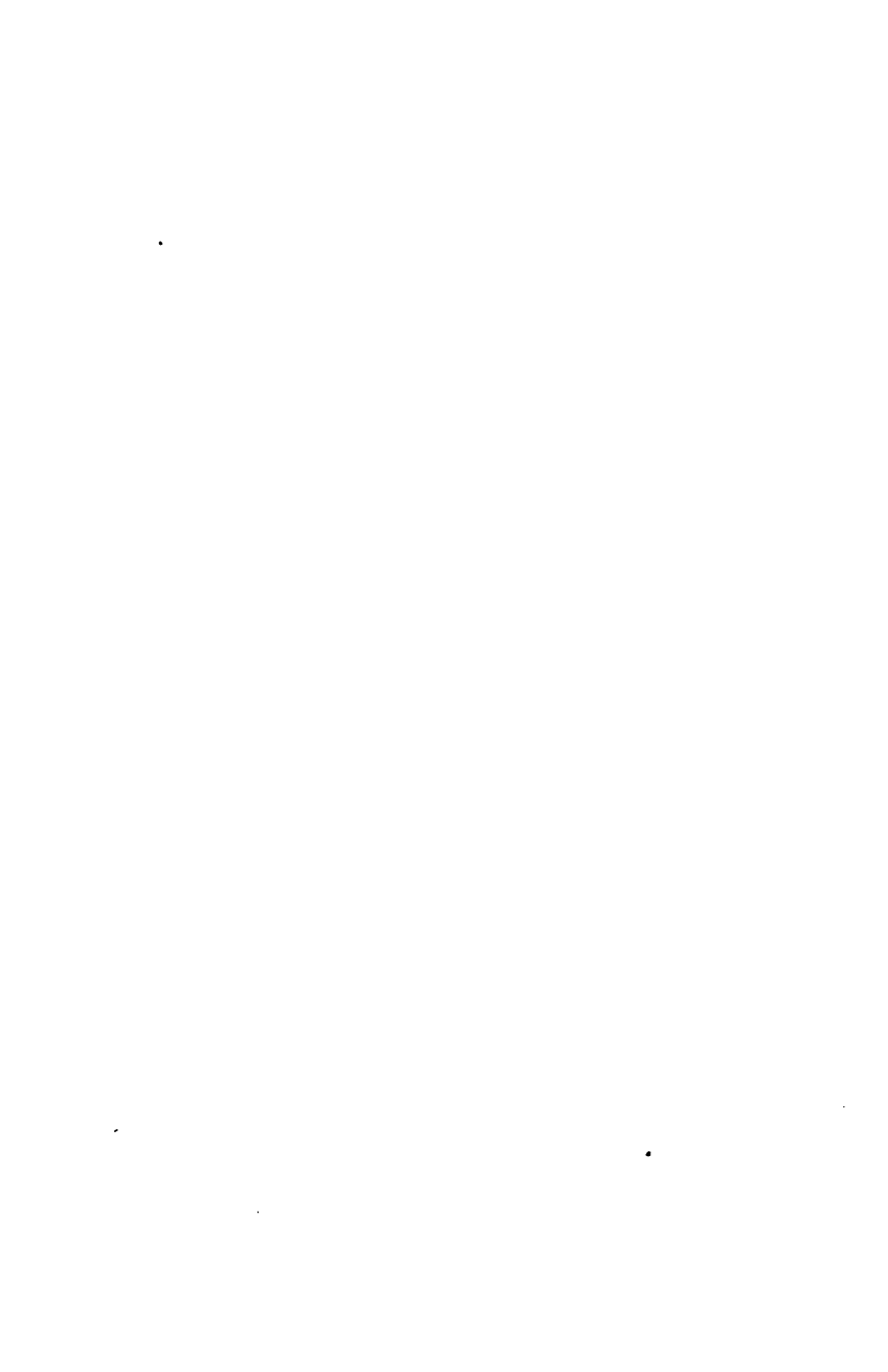

the North British engines have to work on the West Highland section necessitates a very high tractive power, and to attain it Mr. Holmes, in 1894, constructed engines with driving-wheels 5 feet 7 inches. Up to the present time the Company has constructed twelve more engines at Cowlairs, numbered 227, 231, 232, 341, 342, 343, 344, 345, 346, 702, 703, and 704. Their leading dimensions are:—

Four coupled bogie tender engines.

Diameter of bogie wheels	3 ft. 6 ins.
" of coupled wheels	5 " 7 "
" of cylinders	1 " 6 "
Stroke	2 " 0 "
Centre of bogie to centre of driving-wheel	9 " 10 "
Centres of bogie wheels	6 " 6 "
" " coupled wheels.. .. .	8 " 2 "
Wheel base of engine	21 " 3 "
Boiler, length of barrel	10 " 2½ "
" Diameter	4 " 5½ "
Length of fire-box (outside)	5 " 5 "

Heating surface, fire-box.. 104·72 sq. ft.

Tubes 1130·41 " "

Total 1235·13 " "

Area of fire-grate .. 17 " "

No. of tubes 236, external diameter 1½ ins., working pressure 160 lbs. per square inch.

Weight of engine in working order:—

	tons.	cwts.	qrs.
Bogie wheels	15	0	0
Driving "	14	10	0
Trailing "	13	16	0
Total	43	6	0

Tender, diameter of wheels 4 ft. ; wheel base 12 ft. ; capacity of tank 2,600 gals. ; weight in working order 32 tons.

These engines are fitted with the Westinghouse automatic brake.

Another instance of small driving-wheels for express trains is to be found on the Great Western Railway. The "Duke of Cornwall" type, Nos. 3,252 to 3,261, has been specially designed and constructed at the Swindon Works by Mr. William Dean, Locomotive Superintendent, to convey the fast West of England traffic over the heavy gradients which exist between Plymouth and Exeter.

The engines have a leading bogie and four coupled wheels of 5 feet $7\frac{1}{2}$ inches diameter. The cylinders are 18 inches diameter and the stroke 26 inches, consequently the tractive power which these engines are capable of exerting for every pound of mean effective pressure per square inch on the pistons is thus $\frac{18^2 \times 26}{67 \cdot 5}$ = 124·8 lbs., and as the boiler is worked at a pressure of 160 lbs. per square inch and the weight upon the coupled wheels is $28\frac{1}{2}$ tons, it follows that the engines are well able to deal with fast and heavy trains, and the result of the author's riding with them has proved that the engines are doing some very satisfactory work.

The boiler has a steam pressure of 160 lbs. per square inch—

HEATING SURFACE.

Tubes	1,285·58 sq. ft.
Fire-box	112·60 " "
	<hr/>
Total	1,398·18 " "
	<hr/>
Fire-grate area	19 " "





Fig. 119.—Caledonian Railway Express Engine, No. 721, built 1896.

[To face p. 227.

WEIGHT IN WORKING ORDER.

					tons.	cwts.
On bogie wheels	17	10
On driving "	15	7
On trailing "	13	3
Total	46	0

TENDER.

Capacity	2,000	gallons.
Weight	24 tons.
Total weight of engine and tender	70 "

The leading bogie wheels, and also all six tender wheels, are of Mansell's wooden disc pattern, which is unusual in locomotive practice; the engine has an American extension-front or smoke-box, which is a decided innovation upon the Great Western Railway, and is found very efficient in preventing the throwing of sparks.

Ten other engines of similar design were under construction at Swindon in 1896.

The Caledonian Railway Company provides locomotive power to work the West Coast through trains north of Carlisle; and with a view to avoid the use of double engines, Mr. M'Intosh, the Company's Locomotive Superintendent, designed and constructed fifteen express engines, the first of which was named "Dunalastair," and is shown in Fig. 119, the illustration being reproduced from a photograph by Mr. D. H. Littlejohn, of Dundee, taken upon the first day that the engine ran.

The most important feature in the design is the vast size of the boiler and its height above the rails. Mr. M'Intosh is following very much upon the lines of the American designs; he sees that a large boiler is a

necessity, and to obtain space for the diameter he requires he has raised the boiler so that it overhangs the coupled wheels. The cylinders are $18\frac{1}{2}$ inches diameter by 26 inches stroke, the four coupled-wheels being 6 feet 6 inches diameter. These dimensions produce a tractive force of a trifle over 111 lbs. for every pound of average effective cylinder pressure. Taking this at 100 lbs. we find a tractive effort of 11,100 lbs. The load on the four coupled wheels is 31·25 tons, or a little less than 5·5 times the tractive effort. The slide valves are placed between the cylinders, and are worked by "link motion."

BOILER.

Height of centre of boiler from rails	..	7 ft. 9 in.
Length of barrel	10 ft. $3\frac{1}{2}$ in.
Diameter of barrel (mean)	4 ft. $8\frac{1}{2}$ in.

HEATING SURFACE.

Tubes	1,284·45 sq. ft.
Fire-box	118·78 sq. ft.
Total	1,403·23 sq. ft.
<hr/>	
Fire-grate area	20·63 sq. ft.
Working pressure per square inch ..	160 lbs.

WEIGHT OF ENGINE IN WORKING ORDER.

	tons.	cwts.	qrs.
Bogie wheels	15	14	3
Driving ,,	16	0	0
Trailing ,,	15	5	0
Total	46	19	3
<hr/>			
Weight of tender in working order	39	1	2
Total weight of engine and tender in working order	86	1	1

The tender runs on six wheels and carries 3,570 gallons of water.

Of course, these engines, like the whole of the Caledonian rolling stock, are fitted with the Westinghouse automatic brake.

Several engines of the 721 class are stationed at Perth, and run to Carlisle and back each day with the heaviest and most important trains, the results of working being highly satisfactory, and they will take an important part in the next race to the North, when they may be expected to do some fine running between Carlisle and Aberdeen.

Mr. Wilson Worsdell, Locomotive Superintendent of North-Eastern Railway, in 1896 designed and constructed five express engines for the "East Coast" trains, these fine locomotives being among the largest which have ever been constructed in this country. The cylinders are 20 inches in diameter, and have a stroke of 26 inches. There are four coupled wheels of 7 feet 7 $\frac{1}{4}$ inches in diameter, 4 inches larger in diameter than any four coupled wheels hitherto used. The leading end of the engine is carried on a four-wheel bogie. The boiler is 4 feet 4 inches in diameter, and over 11 feet in length. The fire-box is 7 feet long, and the height of the centre of the boiler from the rails is over 8 feet.

These engines are fitted with the Westinghouse automatic quick-acting brake, and are provided with the very excellent *cab*, introduced on the North-Eastern Railway by Mr. T. W. Worsdell.

The boilers are constructed to carry a pressure of 200 lbs. per square inch, but at present the engines are

being tested with various pressures from 175 lbs. upwards, and the one giving the best results will of course be adopted as the working pressure. It is not the intention of the Company to publish any official table of dimensions until after the fast running has commenced in July, but it is a well-known secret that one of the new engines, No. 1,869, has made a private experimental trip which proved highly satisfactory, the whole distance from Newcastle to Tweedmouth being covered at an average speed of 70 miles an hour from start to stop. The North Eastern Company has, with a view to reduce the weight of its tenders, adopted the "water-trough-system," and it will be in use by the time this volume is in the hands of the readers, and the new tenders will carry 3,000 gallons of water only. Although the full dimensions may not at the present be stated, it is no secret that in addition to the five engines already completed, ten others are under construction, and a large number of tenders are being fitted with the water scoop. Two other railway companies are also contemplating the adoption of the "water-trough," but it is not certain if they will be able to complete the apparatus for this year's racing.

Before leaving the Great Southern and Western Railway of Ireland, Mr. Ivatt designed and constructed a large express engine with a leading bogie and four coupled wheels, the important feature being that by means of a special arrangement introduced by him the engine can be worked as a "simple" engine or as a "compound" at the wish of the driver; this is an important step in the right direction, and gives the driver full power to work the engine to the best advantage. Careful experiments made with this engine,

working one day "simple" and the next "compound," will throw much light upon this important subject.

Upon Mr. Ivatt, formerly of the Great Southern and Western Railway of Ireland, being appointed Locomotive Superintendent of the Great Northern Railway, what was held to be a great defect in the Great Northern engines—namely, the absence of a dome on the boiler—was again discussed amongst the engine-drivers. For years they had asked for a dome, but Mr. Stirling would not consent. It has, therefore, given much satisfaction to the drivers to know that Mr. Ivatt is an advocate of the "steam dome," and they express the hope that he will be an advocate also of the American cab.

Mr. Eric G. Barker, Locomotive Superintendent of the Wirral Railway, Birkenhead, has designed, and Messrs. Beyer, Peacock & Co. have completed a twelve-wheeled tank engine for that line, No. 11. It has a leading bogie, four coupled wheels of 5 feet 2 inches diameter, and a trailing bogie. Cylinders, placed inside, 17 by 24. Total weight 59 tons 16 cwts. 1 qr. The double-bogie arrangement is found to give very satisfactory results. Boiler pressure, 160 lbs.

At the present time the question of *cabs* is engaging the attention of drivers upon nearly all the important lines, and they have asked their various companies to give them the same *cabs* as provided by the North-Eastern Railway. In several cases the requests have been acknowledged, and it is said that "the matter shall have attention." The author trusts this may lead to the general use of the American *cab* in this country, but he is, of course, quite aware that the "cab" costs more money than the weather-board, and that this is the reason why the Directors of many lines have in the past delayed its introduction.

CHAPTER X.

MODERN DEVELOPMENTS.—AUTOMOBILISM.

COMMENCING in July, 1893, several of the English railway companies for the first time introduced the third-class dining-car upon the most important express trains, and as previously to that addition the trains of the period were as heavy as the engines could well manage, it speedily followed that the addition of a 30-ton dining-car rendered a second engine necessary. This alteration was followed by a large increase of first-class sleeping-cars upon the night trains, and by a general introduction of new rolling-stock, mostly upon the corridor principle, with the result that the weight of trains gradually doubled, and it was found that during the years 1896, 1897, and 1898 the use of a pilot or second engine became the rule. In fact, during those years there were numbers of trains which always had two engines.

To avoid this double engine running, locomotive superintendents in the first place rebuilt many of their existing engines, making great improvements, such as enlarging the cylinders, increasing the size of the boiler, and also the pressure of steam. So satisfactory did these alterations prove that new engines were built upon the designs of the rebuilt engines, but in most

instances still larger. By this means the locomotive departments overcame their difficulties, but events soon showed that the success was only destined to be of very short duration, as the traffic departments insisted upon the speeds being increased and more carriages being attached to the trains. At the same time the carriage departments were practically compelled by competition and public opinion to withdraw from express service the old light four or six-wheeled coaches, and to build eight or twelve-wheeled bogie vehicles of the heaviest and most modern description.

Locomotive superintendents thus found themselves placed in a very difficult position—on the one hand, tied down by the dimensions of the bridges and the loading-gauge, and on the other required to provide engines capable of conveying trains double the weight at an increased speed.

In many instances the difficulties have been overcome by the construction of modern engines upon the general design of former types, but with greatly increased dimensions. In other instances locomotive superintendents have found it necessary to adopt, or at least to experiment with, engines of types not previously used in this country; and the object of adding this chapter to the previous history is to illustrate and describe some of the most important of these new departures in locomotive practice.

In the first place, it must be recorded that express engines having four cylinders constructed upon various designs have been introduced upon British railways, and no less important is the employment of express engines having ten wheels. The use of piston-valves, the introduction of the Belpaire fire-box, and the

heating of trains by means of steam or hot water from the boiler of the locomotive, are also points of considerable interest.

Mr. James Manson in 1897 designed and constructed a four-cylinder express engine, No. 11, at the Glasgow and South-Western Company's works, having a leading bogie and four coupled wheels of 6 feet 9½ inches diameter. The two inside cylinders are 14½ × 26, and the two outside have a diameter of 12½ × 24 stroke; high pressure steam being supplied to all four cylinders, the connecting-rods working upon one axle. The boiler pressure is 165 lbs., but the total heating surface being only 1,205 square feet, prevented the cylinder power being used to the full extent.

In 1897 Mr. F. W. Webb, of Crewe, decided not to construct any more of his three-cylinder compound engines, and to turn his attention to the four-cylinder type, and during that year he completed two express engines, each having two inside and two outside cylinders, all four working directly upon one pair of driving wheels, but coupled to a trailing pair.

One of these experimental engines was named "Iron Duke," and was a "simple" engine, having high-pressure steam in all four cylinders; and the other was named "Black Prince," being a "compound," having the high-pressure cylinders outside and the low-pressure cylinders inside.

At the conclusion of the experiments with the two engines, Mr. Webb determined to convert the simple engine to a compound, and to construct fifty-eight other engines of the same pattern. The whole of the order is complete, and the engines are numbered from 1901 to 1960. One of these, "La France," No. 1926, was sent to

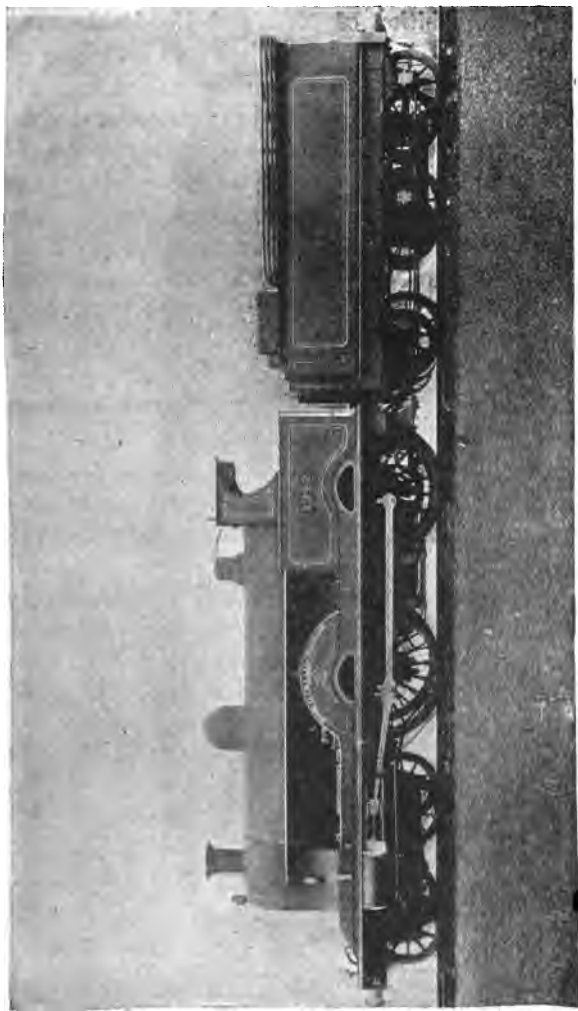

Fig. 120.—“King Edward VII.,” Four-Cylinder Compound Express Engine, No. 1942, London and North-Western Railway. Built at Crewe, 1901.

the Paris Exhibition of 1900, and No. 1942—"King Edward VII."—is illustrated in Fig. 120.

The chief dimensions were: cylinders, two high-pressure, 16 inches \times 24 inches; two low-pressure, 20½ inches \times 24 inches; total heating surface, 1,557·5 square feet; steam pressure, 200 lbs. per square inch; height of boiler-centre from rails, 8 feet 1½ inches; weight of engine in working order, 57 tons 12 cwt.; weight of engine and tender in working order, 84 tons 4 cwt. The tender, in consequence of the water-trough system, is light compared with the engine.

Mr. D. Drummond, upon the London and South-Western Railway in 1901, constructed a further number of his four-cylinder engines of the 369 class similar to his previous experimental engine, No. 720, built 1897. These engines (Fig. 121), have a leading bogie and two pairs of perfectly independent driving-wheels. The first pair of wheels is driven by two inside cylinders, and the trailing pair of drivers is actuated by a pair of outside cylinders. The fire-boxes are provided with water-tubes, and the tenders run upon two four-wheeled bogies.

Two types of ten-wheeled express engines have been introduced upon the Great Northern Railway by Mr. Ivatt. In the first place, he constructed No. 990, having a leading bogie, four coupled wheels, and a small pair of trailing wheels, and a pair of outside cylinders, 19 \times 24; the connecting-rods working upon the second pair of 6-foot 6-inch coupled wheels. However, the second type, No. 271 (Fig. 122), is a ten-wheeled engine, having four cylinders, 15 inches diameter and 20 inches stroke, two placed inside and



Fig. 122.—Mr. Ivatt's Four-Cylinder Express Engine, Great Northern Railway, No. 271 (1902).

two outside, and working upon the first axle, high-pressure steam being used in all the cylinders.

The inside cylinder type of ten-wheeled express engine was introduced by Mr. Aspinall upon the Lancashire and Yorkshire Railway, being a large edition of that company's leading bogie and four-coupled wheel class, but having a Belpaire fire-box and a small pair of wheels under the footplate, the two cylinders inside being 19×26 , and the four coupled wheels 7 ft. 3 in. diameter. For illustration (No. 1,400), see Fig. 123.)

Mr. Worsdell has designed and constructed for the North-Eastern Railway two types of ten-wheeled (six wheels coupled) express engines. The first of these, built in 1899, have coupled wheels 6 feet $1\frac{1}{2}$ inches diameter, and cylinders 20 inches \times 26 inches; height of centre line of boiler above rails, 8 feet 2 inches; total heating surface, 1,769 square feet; steam pressure, 200 lbs. per square inch; weight of engine in working order, 62 tons 5 cwts.; weight of engine and tender in working order, 98 tons 17 cwts.; and commencing at No. 2,001.

The 2,111 class (Fig. 124), however, has coupled wheels of 6 feet $8\frac{1}{4}$ inches diameter, the cylinders being 20 inches \times 26 inches; height of centre line of boiler above rails, 8 feet $6\frac{1}{8}$ inches; total heating surface, 1,769 square feet; steam pressure, 200 lbs. per square inch; weight of engine in working order, 67 tons 2 cwts.; weight of engine and tender in working order, 107 tons 2 cwts. These engines are giving very satisfactory results in working upon the heaviest East Coast Scotch express trains.

At the Derby works, in 1901, Mr. S. W. Johnson constructed the first five of a larger class of his coupled

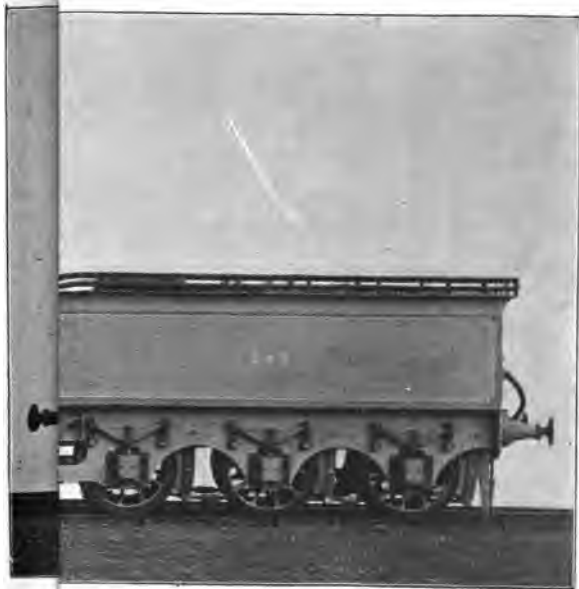

gine, No. 1400 (1899).

[To face p. 238.]



North-Eastern Railway (1900).

[To face p. 238, after Fig. 123.]

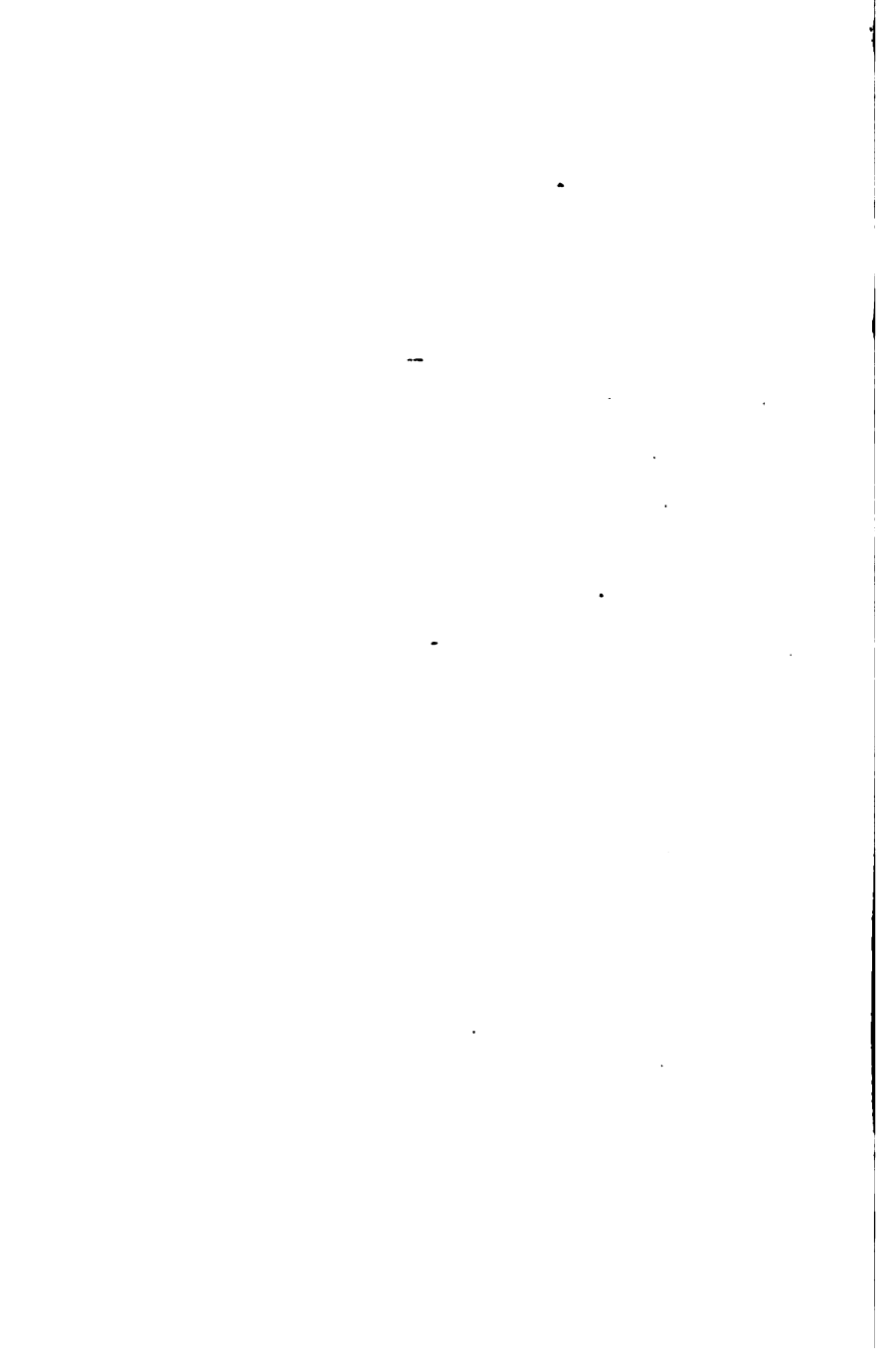

engines, following the general design of Fig. 75, p. 134, but having a Belpaire fire-box, the dimensions being cylinders, $19\frac{1}{2}$ inches \times 26 inches; driving and coupled wheels, 6 feet 9 inches; height of boiler centre above rails, 8 feet 3 inches; steam pressure, 180 lbs. per square inch; total heating surface, 1,519.0 sq. ft.; grate area, 25.0 sq. ft.; weight of engine in working order, 51 tons 12 cwts. The tender runs upon two bogies and carries 4,000 gallons of water. Weight of engine and tender in working order, 102 tons 19 cwts.

These engines, which are numbered 2,606 to 2,610, were put to work the heaviest Scotch trains between St. Pancras and Leeds, and others of a similar type have been constructed having tenders to carry 4,500 gallons of water.

During the year 1898 the North-Eastern Railway Company rebuilt at its Gateshead works one of its two-cylinder compound engines, No. 1,619, as a three-cylinder compound. As thus altered this engine has a four-wheeled leading bogie and four coupled wheels, the three cylinders having their connecting rods working upon the driving pair of wheels: the engine has one high-pressure cylinder (inside) 19 inches \times 26 inches; two low-pressure cylinders (outside) 20 inches \times 24 inches; coupled wheels, 7 feet $1\frac{1}{4}$ inches diameter; steam pressure, 200 lbs. per square inch; total heating surface, 1,324.0 square feet; weight of engine in working order, 53 tons; weight of engine and tender in working order, 94 tons. A most important feature about the engine is that it can be worked either as a compound, a semi-compound, or as a "simple" engine. After trials it was decided not to construct

any more engines of the type, and to build the new ones as high-pressure engines.

The Midland Railway Company during the year 1902 stationed two new engines at Leeds to work the Scotch express trains from thence to Carlisle, Nos. 2631, 2632; these are three-cylinder engines, and are illustrated in the frontispiece of this volume.

These engines were built at Derby upon a design never before tried upon the Midland, but follow very closely the pattern of the North-Eastern Company's engine No. 1,619, after the alterations of 1898—that is to say, they are compound or semi-compound.

The one inside high-pressure cylinder is 19×26 , and the two low-pressure or semi-low-pressure cylinders are each 21×26 , the coupled wheels being 7 feet diameter, and the boiler pressure 195 lbs.

The one inside cylinder receives high-pressure steam direct from the boiler, and the exhaust steam from this cylinder is turned into the steam chest dividing its steam between the two outside cylinders. The official details state that "when working compound, the pressure in the low-pressure chests, according to the position of the reversing gear, varies from 40 lbs. to 60 lbs.; but for starting or working a heavy train up a steep incline, increased power can be obtained by admitting steam from the boiler through the regulating valve to the low-pressure steam chests. The amount of high-pressure steam admitted to the low-pressure cylinders is governed by a controlling valve placed inside the cab. By manipulating this valve, the driver can vary the low-pressure steam-chest pressure to suit the work in hand." It will be remembered (see page 93) that as long ago as 1846 Messrs. Stephenson and Howe obtained satisfactory

results with three-cylinder high-pressure engines, and when by means of the regulating valve a liberal supply of high-pressure steam is turned into the two outside cylinders the Midland engines are found to perform some heavy work upon the severe gradients between Leeds and Carlisle.

A great feature in these engines is that a large boiler has been provided, the length of barrel being 11 feet 7 inches, 4 feet $9\frac{1}{8}$ inches in outside diameter, and has its centre pitched 8 feet 6 inches above rail level. One of the engines is fitted with Serve tubes, which alone give 1,569·8 square feet of heating surface; the other engine, which has plain tubes, has 1,448·0 square feet of heating surface in the boiler. The Serve tubes are $2\frac{3}{4}$ inches and the plain ones $1\frac{3}{4}$ inches in external diameter. The inside fire-box measures 7 feet $9\frac{7}{16}$ inches in length, and has a grate area of 26 square feet, the heating surface of the box being 150 square feet. This, added to the respective tube surfaces, gives a total of 1,719·8 square feet in the one case, and 1,598·0 square feet in the other.

The weight of engine in working order is $59\frac{1}{2}$ tons, $38\frac{3}{4}$ tons being available for adhesion. The tender is of Mr. Johnson's double-bogie pattern, holding 4,500 gallons of water, and weighing in running order 52 tons 13 cwts. Engine and tender complete thus weigh 112 tons, the total length over buffers being 60 ft. 10 in.

Turning now from passenger engines to goods and mineral, it is satisfactory to find that several railways have introduced the eight-wheel coupled goods engine in order to convey heavier loads.

The London and North-Western Company obtains good results with four-cylinder compound eight-

wheeled coupled engines, and the North-Eastern employs eight coupled wheels and outside cylinders. The Caledonian (see Fig. 125), the Lancashire and Yorkshire, and the Great Northern companies obtain equal success with the inside-cylinder type.

Although improvements have been made in the goods engines, it is to the goods wagons that more attention should be given, in order to increase the paying load. An American bogie coal wagon, weighing 10 tons empty, carries 30 tons of coal; but in England, to convey 30 tons of coal, three wagons have to be employed, each weighing fully 6 tons 12 cwt. empty; the result being that the English goods engine has to haul about the country twice the amount of useless dead weight that the American engine has to take. To alter the English coal sidings and docks so as to enable the larger wagons to be used will be costly, but it will have to be done if goods traffic in this country is to be made to pay; and most certainly the time has arrived when goods should be carried in large wagons with proper tops and doors, not in the antiquated open wagon covered over with a sheet, which often allows rain to damage the goods.

The Paris correspondent of *The Times*, in the issue of that journal of December 13, 1902, has given particulars of what he styles the "new automobile railway system," about to be introduced into France, and he describes his information thus given as "the first mention of a piece of news which is bound to fill with joy all English travellers."

"On June 18 next," he goes on to say, "at 8.50 a.m., there will start from the Lyons station in Paris a train



igned by Mr. J. F. McIntosh, and constructed
n. ; total heating surface, 2,500 sq. ft. ; steam
eight of engine and tender in working order,

[*To face p. 242.*

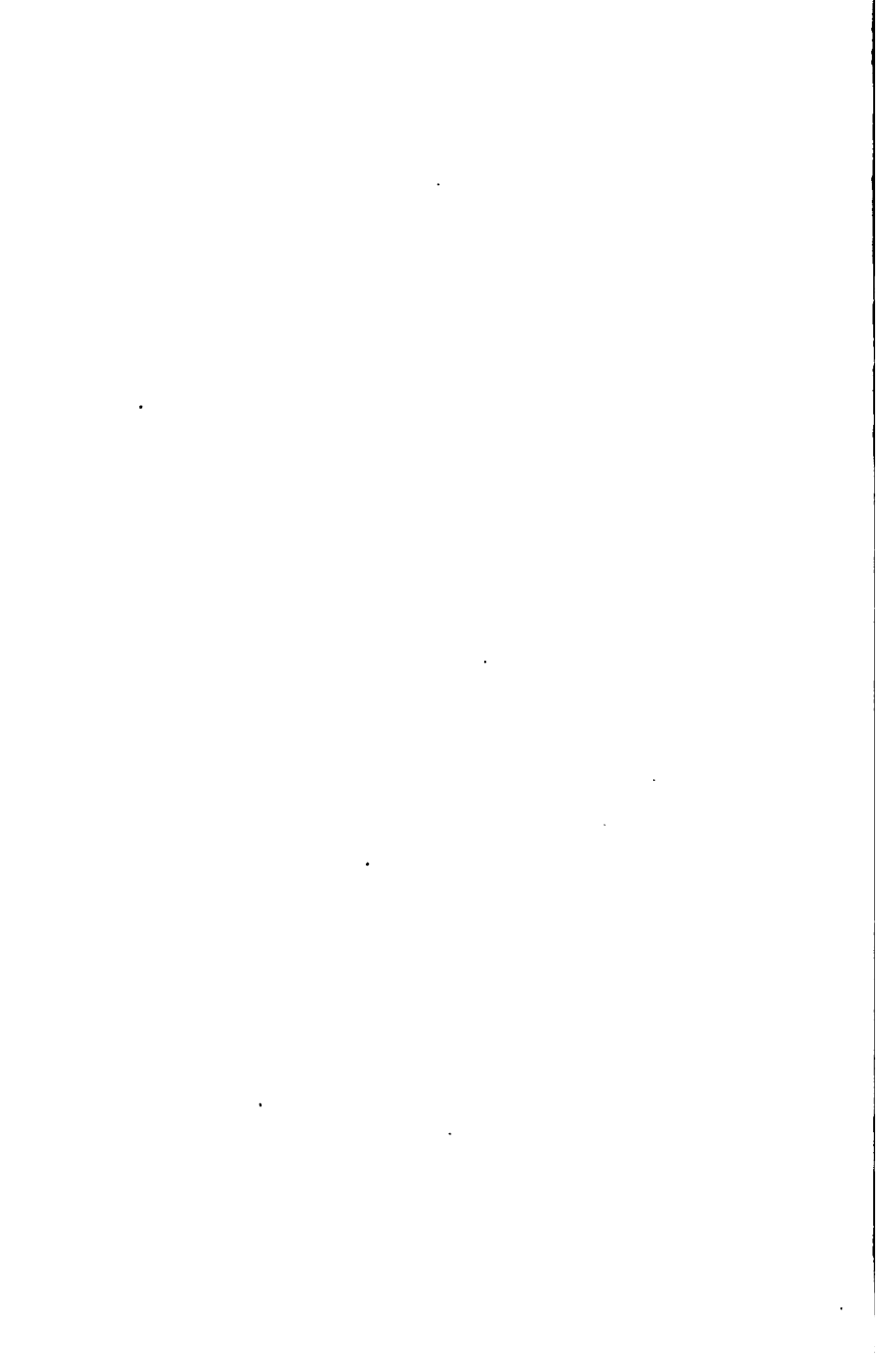

composed of three 'autonobile' carriages—that is to say, carriages that are both autonomous and motor-cars—which will enter the Dijon station at noon. There the 120 travellers carried by the three autonobile wagons will be entertained at luncheon. The 315 kilomètres between Paris and Dijon will thus have been covered in three hours and ten minutes, or at a normal speed of 100 kilomètres per hour ; and the same speed may be maintained between Dijon and Lyons, Lyons and Marseilles, Marseilles and Nice, and Calais and Paris uninterruptedly, so that the distance between Calais and Nice can be covered in 14 hours. I am speaking of the first projected application of motor power, and not of the extraordinary transformation which motor-power will produce in the conveyance of travellers in general.

“ Now that I have briefly described an invention which is now neither a project nor an experiment, but which exists and works, and the application of which is merely postponed for some months for the construction of the actual rolling-stock, I may give some details to explain the very exceptional influence which this new mode of travelling must exercise and the way in which passengers will travel in the autonobile cars.

“ To form an accurate idea of the attention which this new mode of traction and locomotion calls for, it will be sufficient to say that the eminent firm of Gardner and Serpollet undertakes the construction and organisation of the autonobile carriages which on June 18 next will make their first trip between Paris and Dijon. That firm is the one which in two successive competitions for the Rothschild Cup at Nice, 1901 and 1902, beat the record of automobiles by covering the first time

101 and the second time 121 kilomètres an hour, while the third time—for to win the Cup there three records of speed must be made—it proposes to cover 140 or 150 kilomètres an hour. Messrs. Gardner and Serpollet are now constructing the autonomobile carriages whose public appearance will entirely transform, probably in all parts of the world, the mode of conveying passengers. At present, indeed, it will be applied only to the conveyance of passengers, as it requires a special type of carriage, the construction of which demands both time and capital.

“Let me now briefly explain the transformation which with progressive developments in proportion to the construction of the carriages and the resources of the companies the conveyance of passengers will undergo. First of all, as its name indicates, the autonomobile supersedes the locomotive—that is, it dispenses in every train, short or long, slow or fast, with a weight of 110 tons. It saves the considerable cost of locomotives. It abolishes smoke, steam, noise, vibration, the jolt incidental to stopping and starting, and the necessity of stopping to take up water.

“It also abolishes all the men in charge of a locomotive except the engine-driver. The new carriage is 17 mètres long—that is to say, the length of the present corridor carriage. Of these 17 mètres a space of 2·6 mètres in front is occupied by the traction apparatus, while the remaining 14·4 mètres will comfortably accommodate 40 passengers, and the 1,200 kilogrammes of luggage allowed them, besides a lavatory and a handy little bar, where passengers during the journey may always find refreshment. The cost of the autonomobile is the same as that of the first-class corridor

carriage, while the weight, including the traction apparatus, is also the same. Thus the abolition of the locomotive is an accomplished fact, and the rails which now have to bear the weight of the locomotive and tender, as well as of the carriages, are relieved therefrom."

One need hardly say that time only can show whether these sanguine expectations of the "abolition of the locomotive," as we now know it, are to be realised so speedily as *The Times'* correspondent anticipates—if, indeed, room may not be found in the arrangements of the future for the modern "locomotive" and the new "autonobile," each in a sphere of its own.

As to the sources of the tractive power to be utilised in the "autonobile," the same correspondent says:—"The system is one which, in an embryo form and dating back several years, has been applied to short and fast tramway lines, but never to practically unlimited distances. While not, perhaps, using the technical expressions which would be employed by a specialist, I believe I am not mistaken in stating that by means of the slightest possible quantity of petroleum the smallest possible quantity of water can be converted into the greatest propelling power of steam which can be produced. The extremely powerful vapour thus obtained acts directly on the wheels of the autonobile."

It may further be noted that in *The Times* of December 18, 1902, another correspondent calls attention to a system of "Automobilism on Railways," which is about to be tried in England by the North-Eastern Railway Company.

"That company" (this correspondent states) "is at the present moment building at its York works two

autocars to run on its railway, each of which will carry a complete apparatus for generating its own motive power. At one end of the car there will be a Napier petrol engine of 85 brake horse-power, with four cylinders. This engine will drive a dynamo, generating electricity for two motors, which will apply the power to the wheels of the 'bogie' underneath the engine compartment.

"Two of these four-wheeled 'bogies,' of practically the normal railway carriage type, will carry the framework of the car, but the body will be much lighter than that of an ordinary carriage, approaching closely to the tram type. In fact, the vehicle will be a tram saloon, with an engine compartment at one end and a conductor's compartment at the other. Seating accommodation will be provided in each car for 52 passengers; and, as storage is provided for 30 gallons of petrol, it is anticipated that the automobile will be able to work five hours at a stretch without replenishing.

"It is calculated that by this system a speed of 30 miles an hour can be got up in as many seconds, which is a very much quicker acceleration than is possible with an ordinary train. It is not proposed to use these autocars at first for the longer distance traffic of the North-Eastern Railway, but to employ them rather for accelerating the service on those sections of the system where an ordinary train can only make a slow rate of speed owing to the number of stopping places. The two cars now under construction are destined to run between Hartlepool and West Hartlepool stations, where there is keen competition with a tramway service. If the experiment be successful, other sections of the company's system are to be similarly equipped."

CHAPTER XI.

MAIN QUESTIONS OF DESIGN—THEORY OF LOCOMOTIVE MOTION—RULES AS TO GRADIENTS—CENTRE OF GRAVITY OF LOCOMOTIVE—SUNDRY APPLIANCES.

IN technical detail as well as in outward appearance, locomotives, as these pages show, vary considerably; and these variations are naturally of very considerable interest to locomotive engineers and also to the general public. However, it yet remains true that the general principles of all are more or less closely allied to each other; and, although their construction and dimensions may differ, all their variations or special arrangements are mere devices for the better and more efficient utilisation of their power. The four great points in a locomotive are, of course:—

1. The boiler—in which the steam is generated.
2. The cylinders—in which it is utilised to force the piston alternately from end to end, the length of the stroke being regulated by the throw of the crank according to the length of the cylinder.
3. The throw of the crank of the axle of the driving wheel; and

4. The size of the driving wheel.

Hence the four most important questions regarding all locomotives are : first, the diameter of the cylinders ; second, the length of the stroke ; third, the diameter of the driving wheels ; and fourth, the pressure of steam in the boiler. It is upon these points that the whole of the changes in locomotive construction are rung ; they are the keynotes which dominate the whole ; and these particulars being given, all the rest, to a practical engineer, becomes more or less a matter of detail.

Of course there are other questions which arise on different railways—such, for example, as to whether locomotives should have their cylinders inside the frame, or outside, as in American and other types. Further, the class of coal or fuel which can be secured in different localities has also to be carefully taken into consideration ; and modifications may be considered necessary in the construction of fire-boxes and boiler-tubes to meet the particular circumstances. Then there are other locomotives, such as those running on the London underground railways, which are not allowed to discharge any steam in the tunnels, and which are therefore provided with special condensing apparatus by means of which the steam, instead of being discharged up the chimney into the atmosphere, is turned into the cold-water tank and condensed.

But notwithstanding all these variations, the tendency of all railway companies has for a long time been to adopt certain standard patterns, which give the advantage—a very great one—of all parts being

interchangeable. Each locomotive superintendent, it is true, has his own views and his own designs, and this has led to the construction of engines of great variety, which the superintendents believe to be the most advantageous for their own particular railways. This has brought new ideas to the front, and has promoted the efficiency of locomotive power generally, because each system and every new principle has been brought to the test of practical experience.

The subject of motion or traction—in other words, “How the locomotive engine moves itself,” has always been a matter of much interest, and has formed the basis of lengthy discussion in many parts of the world, and, in too many cases, has not been made clear.

Locomotive men usually consider the engine as a complete self-contained machine, rolling forward upon the rails on account of the adhesion between the driving wheels and the surface of such rails. On the other hand, permanent-way men, and some purely scientific men, prefer to consider the earth and the rails as the basis, and regard the engine as simply working its way forward by means of a series of levers, that is, by the spokes of the driving wheels.

In practice it matters very little from which standpoint we view the subject; but it is most important that the two methods should be kept separate and distinct, or endless complication and confusion must certainly follow, as it has done in years past.

The locomotive men will tell us that the piston moves backwards and forwards in the cylinder; the permanent-way men and the scientific men will say that when the engine is running the piston never goes back-

wards, but that the cylinder comes forward upon the piston. Both these statements are perfectly true and correct when properly examined from the two different points of view. Let a locomotive engine be placed with one crank vertically below the axle, in forward gear, and let steam be admitted. The steam rushes into the front end of the cylinder, and the pressure comes upon the piston in the backward direction, and against the cylinder cover in the forward direction. The backward force against the piston is communicated to the piston-rod, connecting-rod, crank, driving axle, wheel, and rail. The forward force against the cylinder-cover is communicated to the frame, axle-boxes, and driving axle. Now, on account of the leverage, the force in the forward direction against the front cover of the cylinder has far greater effect, and consequently the steam pressure acting on the cover and assisted by leverage forces the cylinder, and, of course, the frame, driving axle, and train of carriages forward.

Let the position of the engine be now changed, so that one crank shall be vertical above the axle. The steam is admitted to the back end of the cylinder, and presses upon the piston in the forward direction, and against the back cover of the cylinder in the backward direction; the piston in this case has the advantage of leverage, and is able to force the crank forward.

The portion of the wheel which at any moment is upon the rail is, for that moment, at rest, and practically the one vertical spoke in the wheel, the axle, and the crank become a lever. Now we have the crank-pin as the power, and the axle as the fulcrum; that is looking at the question from the locomotive man's point of view; but the permanent-way man will maintain that

the rail or the earth must always be the fulcrum. Practically, when the crank is above the driving axle the steam forces the piston forward, and with it the axle and the whole train. It must be remembered that when an engine is running forward, it is only during the forward stroke—that is, when the crank is above the axle—that the pressure on the crank-pin actually moves the engine forward. During the backward stroke the piston is pushing the axle in a backward direction, and the pressure against the front cylinder-cover is pulling it forward; and, as the latter force, on account of the advantage of leverage, exceeds the former, the difference between the two is the force against the front cover of the cylinder, which difference moves the train forward.

To make the matter still more clear, we have only to remember the test which every engineering pupil has seen made occasionally at nearly every locomotive fitting shop, namely, having found a pair of locomotive driving-wheels and axle, taken out of an engine, place one of the cranks vertically above the axle, place one's self in the four-foot way, with one hand upon the crank-pin, the hand and arm then represent the big-end and connecting rod, and the body the force in the cylinder. Let the person pull towards himself, and the result is that the part of the tyre upon the rail remains practically stationary, the axle moves slowly forward, and the top of the wheel moves considerably forward. If the crank be now placed below the axle take hold of the axle-journal and pull it towards the body, the hand then represents the axle-box, the arms the engine-frame, and the body the cylinder and cover. It then becomes clear that the crank-pin, with reference to its position upon the surface of the earth, must always move for-

wards, although with reference to its position upon the engine as a complete self-contained machine, it must move backwards.

Let us now take the case of an engine having driving wheels six feet diameter, length of stroke two feet, and the pressure at the piston and piston-rod 30,000 lb. These dimensions are taken as an illustration because they are even figures, and simple to calculate. The engine is now to be placed in forward gear, with one crank in the vertical position above the axle. Upon steam being turned on, we have a force of 30,000 lbs. acting in a backward direction against the back cylinder cover, and a force of 30,000 lbs. acting in a forward direction against the piston. But the 30,000 lbs. of force on the piston acts at the crank-pin upon the end of a lever four feet long, the fulcrum of which is a foot away, or at the axle. We then have 30,000 multiplied by one foot, that is by the short end, and divided by the long end, three feet, or a total of 10,000 lbs. available to move the engine forward.

Now we will have the engine moved half of the revolution of the wheel, so that the crank shall be vertically below the axle, and we have then a force of 30,000 lbs. acting upon the piston in a backward direction, and 30,000 lbs. against the cylinder cover in the forward direction; but the 30,000 lbs. in the forward direction acts through a lever, one foot in length to the axle or fulcrum, so that 30,000 multiplied by one foot, divided by three feet, being the distance from the axle to the rail, gives the available forward force as 10,000 lbs.

Sometimes one hears it stated that the locomotive subject is a "puzzle," but this is not the case if the actual forces be practically considered.

USEFUL RULES RELATING TO GRADIENTS.

The *vis viva* of a train moving at any given speed is equivalent to the raising of the train to the height, by falling through which it would attain that velocity, and this is true whether the train is raised vertically (if it were possible), or by running it up an incline assuming friction as nil.

Therefore when a train runs up an incline, the engine has not only to overcome the resistance on the level, but also to raise the train to a certain height.

An incline of 1 in 200, for instance, is a rise of $\frac{5,280}{200} = 26.4$ feet per mile. To find the work done (in foot tons) in lifting a train of 200 tons through the vertical height of 26.4 feet, it is necessary to multiply the height by the weight, thus, $200 \times 26.4 = 4,280$ foot tons.

The rates of inclinations of gradients are also conveniently expressed as percentages, which represent the force of gravity acting on different inclines—1 in 200 being expressed as a gradient of 0.5 per cent.; 1 in 100 as 1 per cent.; and 1 in 50 as 2 per cent.

In this country, it is still the practice to express gradients in their proportion or ratio to 1.00 but in America, as in many other parts of the world, gradients are always given in proportion to their rise per mile. To find the rise in feet per mile for any given incline, it is only necessary to divide the feet in a mile (5,280) by the gradient to one; thus in a case of 1 in 264 we have

$$\frac{5,280}{264} = 20 \text{ feet per mile.}$$

When, therefore, the English engineer speaks of 1 in 264, the American engineer refers to it as "a 20-foot grade."

The following table gives the same inclinations expressed by the two methods:—

Gradient to 100.	Equal rise in feet per mile.	Gradient to 100.	Equal rise in feet per mile.
1 in 2,000	2·64	1 in 165	32·0
„ 1,000	5·28	„ 132	40·0
„ 500	10·56	„ 120	44·0
„ 400	13·2	„ 100	52·80
„ 300	17·6	„ 88	60·0
„ 264	20·0	„ 70	75·42
„ 220	24·0	„ 50	105·6
„ 200	26·4	„ 37	142·7

CENTRE OF GRAVITY OF LOCOMOTIVE.

The horizontal centre of gravity of either a bogie or six-wheeled engine should be a few inches in front of the centre of the driving axle. To find this point, multiply the weight resting upon the leading wheels (or leading bogie, if one be used) by the distance in feet from the centre of the driving axle. Multiply the weight upon the trailing wheels by distance in feet from the driving axle. Find the difference, which divide by the total weight of the engine in tons; the quotient is the horizontal distance in feet of the centre of gravity from the driving axle in the direction of the axle carrying the greater weight. As an example, if an engine weighs 41 tons 13 cwt. 2 qrs.; on leading wheels, 14 tons 6 cwt.; on trailing wheels, 12 tons 16 cwt.

14·3 tons × 10 ft. (for leading end of engine) .. 143 ft.-tons
 12·8 tons × 8 ft. 6 in. (for trailing end of engine) .. 108·8 ft.-tons

The difference (34·2), divided by the total weight of the engine (41·68), = ·82 of a foot. Therefore the centre of gravity of the engine is ·82 ft., or $9\frac{7}{8}$ in. in front of the driving-axle.

When a locomotive is running, that portion of the

tread of the tire which is in contact with the rail at any instant of time is at rest, while the corresponding point on the flange on the same radius is moving in the opposite direction to that at which the train is running. The speed being 60 miles an hour, or 88 ft. per second, and the diameter of the wheel over the tread 6 ft., and over the flange 6 ft. 2 ins., the point in the flange will move backwards at the rate of 1.59 miles per hour.

THE STEAM SAND-BLAST.

Every engine-driver is well aware that for fast running, easy riding, and economy both in coal and repairs, nothing can equal an engine having a "single" pair of driving wheels. On the other hand practical experience has taught them that for heavy trains running upon steep gradients, it is absolutely necessary to employ engines having four coupled wheels, in order to obtain the required amount of adhesion, or, as the drivers say, "to tie their legs together."

The useful work which an engine is capable of performing is, of course, limited by the co-efficient or proportion of adhesion which exists, or can be created, between the driving wheels and the rails; in other words, as soon as the effect of the steam in the cylinders produces a tractive force greater than the adhesion, "slipping" is the result. In ordinary practice the co-efficient of adhesion is found to be equal to one-sixth of the weight resting upon the driving wheels expressed as an adhesion of 16.66 per cent., or as an adhesion of 373.3 lbs. per ton.

If the rails be perfectly clean and dry, the adhesion is increased; if perfectly wet, it is but little reduced.

A slight shower of rain, misty weather, and greasy rails will often reduce it to about 280 lbs. per ton ; and in frosty or snowy weather the writer proved by a series of practical experiments that the adhesion became as low as 160 lbs. per ton. It is, therefore, not a matter of surprise that such a serious loss of adhesion should cause a considerable amount of "slipping." To overcome the difficulty the ordinary method of sanding the rails is by means of sand-boxes and pipes which allow sand to run down on to the rails, and in practice it is found that a considerable quantity of sand is used, but a large proportion of it does not fall on the rails, and a further quantity is blown off by the wind : consequently the ordinary sanding arrangement is very inefficient and unsatisfactory.

One of the most important improvements in locomotive

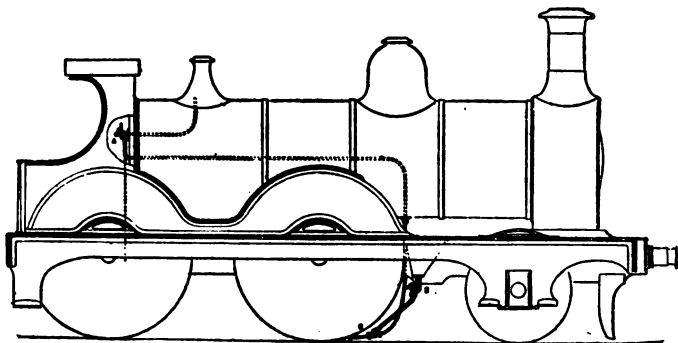

Fig. 126.—General Arrangement of the Sand-blast.

engineering is the introduction by Messrs. Holt and Gresham of their steam sand-blast (Figs. 126 and 127). The general arrangement is shown (Fig. 126) as fitted to some of the Midland Company's engines of the

1,480 and 1,500 classes. By means of a handle, A, steam can be admitted to the sand-ejector, C, thus drawing a small supply of sand from the sand-box, "B," and projecting it in a powerful and constant sand-blast to the point of contact between the wheel

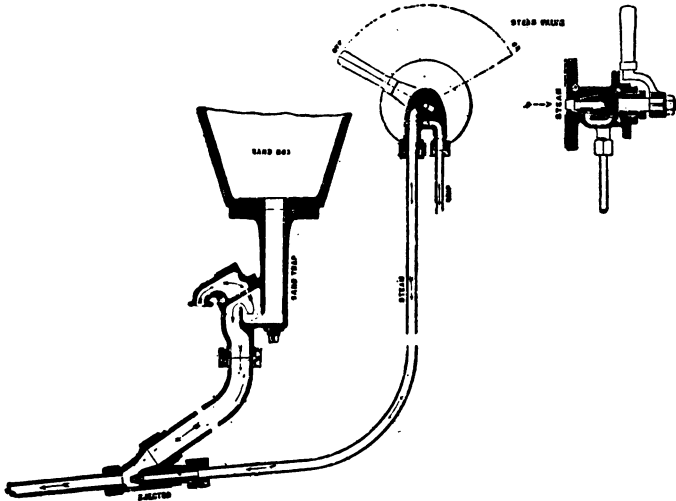

Fig. 127.—Details of the Sand-blast.

and the rail. Fig. 127 shows the apparatus in detail, and it will be observed that the sand falls into the sand trap, and is then carried down in a fine jet by the inrush of air caused by the steam ejector.

THE INJECTOR.

In the early days of railways the boilers of the locomotives were supplied with water by means of force-pumps worked by hand-levers; afterwards the pumps

were worked by either eccentrics or rods attached to the cross-heads, and on the London and South-Western Railway an independent donkey pump was employed to feed the boiler, and at the present time some of the Brighton Company's engines are fed with water by means of a water pump, working in connection with the Westinghouse air brake pump.

Many of my "locomotive" readers will remember the time very well when engines had two pumps, and in order to supply water to the boiler it was necessary to run several times backwards and forwards for about a quarter of a mile to fill up the boiler.

They will also, no doubt, well remember seeing "single" wheeled engines standing in the sheds, with their tender brakes hard on, slipping upon oiled rails, in order to pump water into the boiler.

In July, 1858, Mr. H. J. Giffard, a French engineer, took out a patent for the "Injector"; he had discovered that the motion imparted by a jet of steam to a surrounding column of water was sufficient to force it into the boiler from which the steam was taken, and even into another boiler having a higher pressure.

When Mr. Giffard tried to introduce his new injector, locomotive engineers laughed at him; he was told to read about the first rules of motion, and that he must be mad to suppose that steam from one part of a boiler could force its way back into another part of the same boiler; he could not even obtain authority to try an injector on a locomotive till 1859, and then he was only granted permission as a favour and with a view to "let him prove his idea would not work," and thus put a stop to his constant letters and applications.

However, the injector worked successfully, and the

water entered the boiler, but even then people would not believe it.

Mr. Giffard explained that the action of his injector was similar to that of the blast-pipe in a locomotive: the rush of steam in that case formed a partial vacuum into which air was forced by the atmospheric pressure of about 15 lbs. per square inch.

To explain his theory Giffard took a pressure of 100 lbs. per square inch, and showed that a column of water 23-10 feet high presses upon its base with a force of 1 lb. per square inch, therefore 100 lbs. pressure is equal to a pipe of water 230 feet high.

Water from the bottom of a pipe 230 feet high would rush out at a speed of $121\frac{1}{2}$ feet per second, that is equal to no less a pace than 83 miles an hour.

Let it be clearly understood that a boiler having a pressure of 100 lbs. per square inch is just balanced by a jet of water rushing at 83 miles an hour: it then becomes certain that to overcome the steam in the boiler it is only necessary to increase the speed of the water to above 83 miles an hour, and the water will force itself into the boiler.

It is a well-known fact that the steam pressure in the valve-chest of a locomotive is actually greater than it is in the boiler, this being due to the momentum with which the steam rushes past the regulator and down the steam pipe.

In the same manner the velocity of the steam rushing through the injector is so great that it not only has force enough itself to rush back into the boiler, but also carries the water with it.

Giffard's patent has long since expired, and injectors are now made by various firms, principally by Messrs.

Gresham and Craven, who have upwards of 100,000 of their construction of injector in use.

Fig. 128 illustrates a section of the appliance, the

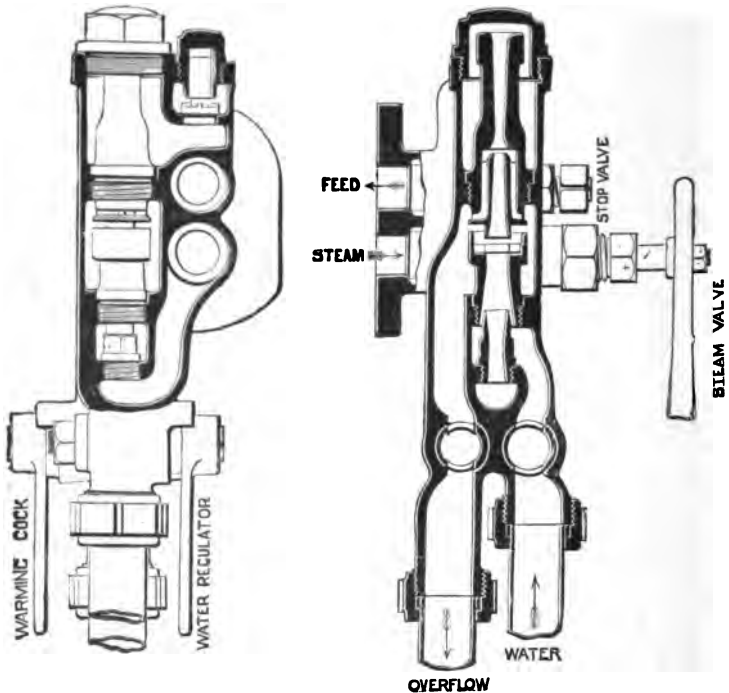

Fig. 128.—Details of Injector.

steam valve, back pressure valve, stop valve, and regulator being plainly shown.

The following are the instructions for working the Gresham combined injector:—

- (1) Open the water cock and turn on steam :

(2) If there is any overflow, close the water regulator until it ceases. The injector is then at work. The water cock should be kept closed when the injector is not at work.

The water pipe can be drained to prevent freezing by closing the tender valve and opening drain cock fixed on water pipe.

Should steam be blown into the tender through the injector, the water pipe must be drained to clear it of hot water.

The back pressure valve must be kept ground tight upon its seat. This can be done, or the whole of the cones can be removed if required, whilst the boiler is under steam by first closing the stop valve.

It is well known to engine-drivers that injectors will not work with very hot water, and in practice it is not advisable for the water in the tender to be heated to above 120 deg.

Having thus considered the theory of the injector, we now turn to its practical results; the annexed table shows the sizes 7 to 10 which are in general use on locomotives, and the number of gallons of water which each will supply per hour at pressures of from 100 to 180 lbs., and of course if the quantity per minute is required it is only necessary to divide the gallons by 60.

TABLE GIVING THE SIZE AND DELIVERY OF COMBINATION INJECTORS.

Size of Injector in Milli- metres.	BOILER PRESSURE IN LBS. PER SQUARE INCH.									
	100	110	120	130	140	150	160	170	175	180
	DELIVERY IN GALLONS PER HOUR AT ABOVE PRESSURES.									
7 ..	970	1,020	1,060	1,110	1,150	1,190	1,225	1,255	1,265	1,275
8 ..	1,270	1,330	1,390	1,450	1,500	1,550	1,600	1,640	1,655	1,670
9 ..	1,610	1,680	1,760	1,830	1,900	1,970	2,030	2,080	2,100	2,120
10 ..	1,980	2,080	2,170	2,290	2,350	2,430	2,500	2,560	2,585	2,610

VALVE GEAR.

Reference has been made to several forms of valve gear, for instance, those described at pages 45, 62, and Howe's celebrated link motion (page 87). Whatever form of gear is employed, when the driver "reverses" the engine he moves one of the valves so as to open either the front or back port at pleasure. Now let us trace the action of the steam. Upon the regulator being opened, steam rushes from the dome or steam pipe down to the valve chest, where in consequence of the "lead" the valve is about one-eighth of an inch open when the crank is upon the dead centre (the two cranks are always made at right angles, so that one is in a position to pull the other past its dead point). The steam having entered past the valve, rushes into the cylinder, and the period of "admission" commences; the steam having forced the piston forward for a distance of let us say eight inches, the valve closes and no more steam is admitted; this is known as "cut off" or point of "suppression"; and for the next part of the stroke the piston is not forced by fresh steam from the boiler, but by the "expansion" of the steam which is imprisoned in the cylinder.

We will now suppose that "expansion" has done its work, and that the piston has been forced, say to 20 inches: the period of "release" then arrives, when the inside of the valve opens the port and permits the steam which has done its work to rush from the cylinder, through the inside of the valve to the exhaust port, and then up the blast-pipe and out of the chimney. The "lead" of the valve causes it to open before the piston arrives quite at the end of its stroke; this

serves two good purposes: first, to form a cushion to reduce the force of the advancing piston, and, secondly, to enable steam to be entering the cylinder early, ready for the next stroke.

An express engine having wheels of 7 feet diameter, or 22 feet in circumference, passes over 88 feet, or four revolutions, per second, when running at sixty miles an hour; thus in one second of time, there must be "admission," "cut off," "expansion," "exhaustion," and "compression," no less than four times from each end of the cylinder, or a total of sixteen "beats" or exhausts of steam up the chimney per second.

It is not necessary to tell engine-drivers that which they know perfectly well—namely, that to save steam, and consequently coal, they, by carefully regulating the valve-gear and "cutting-off" the admission of steam to the cylinder *as early as possible*, can get the greatest amount of work and expansion out of the imprisoned steam in the cylinder.

JOY'S VALVE GEAR.

The fundamental principle of this gear is that eccentrics are entirely dispensed with, valve motion being obtained from a point in the connecting-rod, produced by a combination of two motions at right angles to each other, and by the various proportions in which these are combined, and by the positions in which the moving parts are set with regard to each other, it gives both the reversal of motion and the various degrees of expansion required. By utilising independently the backward and forward action of the rod, due to the reciprocation of the piston, and combining this with

the vibrating action of the rod, a movement results which is suitable to work the valves of engines allowing the use of any proportions of lap and lead desired.

The main valve-lever is pinned to a link, one end of which is fastened to the connecting-rod, and the other end maintained in about the vertical position by a radius rod, which is fixed to the frame near to the leading axle. The centre or fulcrum of the valve-lever partaking of the vibrating movement of the connecting-rod, is carried in a curved slide.

From the upper end of the valve-lever motion is communicated direct to the valve by the valve-rod. It will thus be evident that by one revolution of the crank the lower end of the valve-lever will have imparted to it two different movements, one travelling in length in consequence of the stroke, the other up and down in consequence of the revolution of the crank, these movements differing as to time, and corresponding to the part of the movement of the valve required for lap and lead, and that part constituting the port opening for admission of steam.

The former of these is constant and unalterable, the latter is controllable by the angle at which the curved slide may be set by the driver. Very many forms of valve-gear have been tried, but the "Link" motion is the most satisfactory and gives the best results in practice.

APPENDIX.—RAILWAY SPEED.

RAILWAY SPEED.

At the time of the Northern railway racing, a number of readers expressed a wish that this volume should contain a Table of Speeds ascertained from mile distances, and the table* annexed is accordingly given :—

RAILWAY SPEED, FROM TIME IN SECONDS RUNNING ONE MILE.

Time in seconds.	Speed in miles an hour.	Time in seconds.	Speed in miles an hour.	Time in seconds.	Speed in miles an hour.	Time in seconds.	Speed in miles an hour.
36	= 100	48·64	= 74	75	= 48	156·52	= 23
36·36	= 99	49·31	= 73	76·60	= 47	163·64	= 22
36·73	= 98	50	= 72	78·26	= 46	171·43	= 21
37·11	= 97	50·70	= 71	80	= 45	3min.	} = 20
37·50	= 96	51·42	= 70	81·82	= 44	180	
37·89	= 95	52·17	= 69	83·72	= 43	189·47	= 19
38·30	= 94	52·94	= 68	85·71	= 42	200	= 18
38·71	= 93	53·73	= 67	87·80	= 41	211·77	= 17
39·13	= 92	54·54	= 66	90	= 40	225	= 16
39·56	= 91	55·38	= 65	92·30	= 39	4min.	} = 15
40	= 90	56·25	= 64	94·74	= 38	240	
40·45	= 89	57·14	= 63	97·30	= 37	257·14	= 14
40·90	= 88	58·06	= 62	100	= 36	276·92	= 13
41·38	= 87	59·01	= 61	102·85	= 35	5min.	= 12
41·86	= 86	60	= 60	105·88	= 34	327·27	= 11
42·35	= 85	61·01	= 59	109·09	= 33	6min.	= 10
42·85	= 84	62·07	= 58	112·50	= 32	400	= 9
43·37	= 83	63·15	= 57	116·13	= 31	450	= 8
43·90	= 82	64·28	= 56	2min.	} = 30	514·28	= 7
44·44	= 81	65·44	= 55	120		10min.	= 6
45	= 80	66·66	= 54	124·14	= 29	12	„ = 5
45·57	= 79	67·92	= 53	128·57	= 28	15	„ = 4
46·15	= 78	69·23	= 52	133·33	= 27	20	„ = 3
46·75	= 77	70·59	= 51	138·46	= 26	30	„ = 2
47·36	= 76	72	= 50	144	= 25	60	„ = 1
48	= 75	73·47	= 49	150	= 24		

* The table is, of course, obtained by the usual formula, namely, the seconds in one hour—that is 3,600—divided by the time taken to run one mile; and there can be no doubt that for timing very high speeds more exact results can be obtained from mile distances than from quarter-miles.

INDEX.

- A** BERDEEN, race to, 180, 182
Adams, Mr. W., 149
"Agenoria," 29
Allan, Mr. Alexander, 88, 89
Allen, Mr. Horatio, 27
Altoona, 194
American engines, 81, 188, 195 ;
Trips upon, 193
Arbroath and Forfar Railway,
77
Aston, Mr., engine by, 182
Automobilism in France, 242 ;
on North-Eastern Railway, 245
- B**ALDWIN Works, 193
Barker, Mr., 231
Battle of the gauges, 72
Beyer, Peacock & Co., engines
by, for Midland, 131 ; Metro-
politan, 158 ; Mersey, 160 ;
Wirral, 231
Billinton, Mr. R. J., engines by,
183
Birmingham and Gloucester en-
gines, 47, 81
Blenkinsop, 7
Bloomer type, 105
Bodmer, engines by, 97
Bolton and Leigh Railway, 25
Brighton engines, 124, 130, 183
Bristol and Exeter engines, 107,
217
Broad gauge, introduced, 73 ;
removed, 168, 208
- Brunel, Mr., 72
Buchanan, Mr., design by, 190
Bury, Mr. Edward, 40, 60, 61,
69, 82, 200
- C**ABRY, Mr. Henry, 52
Cabs, 231
Caledonian Railway, 136, 242
Cambrian Railways, 182
Carmichael & Co., 56
Chicago Exhibition, 188, 189
Coal burning, 108
Collision at Thornton, 51
Compound engines, 128, 140 ;
compound (semi), 240
"Cornwall," The, 101
Crampton's patent, 92, 99, 214,
215
Crewe Works opened, 90
- D**EAN, Mr. William, engines
by, 167, 178, 226
Design, main questions of, 247
Dome, an advantage, 168, 180,
231
Drummond, Mr., 182, 236
Dübs & Co., engines by, 116
Dunalastair, 227
Dundee and Newtyle, 55
Duke of Sutherland's engine,
"Dunrobin," 222
- E**IGHT coupled wheels, 242
Eighty miles an hour, 140

- Eighty-one, 194
 Empire State express, 190
 Express engines, "6-coupled,"
 194
- FATHER** of the locomotive, 5
 Four-cylinder engines, 22,
 24, 192, 236
 Four eccentrics, 62
 Forrester & Co., 63
- GIFFARD** injector, 258
 Glasgow and South-Western
 engines, 122, 180
 Gooch, Sir Daniel, 73, 94, 206
 Gooch, Mr. John V., 91
 Gradients, rates as to, 253
 Grand Junction Railway, 74,
 89
 Grasshopper springs, 46
 Gravity, centre of, of locomotive,
 254
 Gray, engines by, 97
 Great Eastern, 141, 174
 Great Southern and Western en-
 gines, 170, 230
 Great Western engines, 72, 76,
 167, 201, 206, 226
- HACKWORTH**, Mr. T., 22
 Haigh Foundry gear, 80
 Harrison, Mr. T. E., 76, 204
 Hawthorn & Co., 47, 64; valve
 gear, 65
 "Hector," 79
 "Hercules," 56
 Hetton Colliery engines, 18
 High boilers, 106
 Highland engines, 183
 Holden, Mr., design, 140; liquid
 fuel, 143
 Holmes, Mr., 225
- Howe's link-motion, 87
 "Hurricane," 76
- I**NJECTOR, 110, 258
 Inside cylinders an advan-
 tage, 140
 "Invicta," preserved at Ashford,
 35
 Ivatt, Mr., 231, 237
- JENNY LIND** type, 212
 Johnson, Mr. S. W., en-
 gines by, 126, 131, 161, 183
 "John Bull," 189
 Jones, Mr. D., 222
 Joy's valve gear, 263
- KILLINGWORTH** engines,
 12, 14
 Kirtley, Mr. M., engines designed
 by, 115, 116, 117, 119
 Kirtley, Mr. W., engines by, 154
 Kitson & Co., engines by, 126
- L**ANCASHIRE and Yorkshire
 Railway, 160
 Lambie, Mr., 182
 Leicester and Swannington Rail-
 way opened, 43; engines, 44,
 46, 50, 56, 59, 79
 Link-motion, 87, 200, 263
 Littlejohn, Mr., 227
 Liquid fuel, 143
 "Liverpool," 1834, 61
 "Liverpool," 1848, 102
 Liverpool and Manchester Rail-
 way, Rainhill trial, 30; opened,
 36; engines, 31, 33, 37, 49,
 57, 200
 Locke, Mr., 74
 "Locomotion," 20
 London, Tilbury, and Southend
 Railway, 156

London and North-Western engines, 90, 98, 100, 165, 181
 London and North-Western Jubilee, 234, 242
 London and Birmingham Railway, 47
 London and South-Western Railway, 91, 150
 Long boilers, 84

MANCHESTER, Sheffield, and Lincolnshire Railway
 145; engines, 183, 223
 Manson, Mr., 234
 Marshall and Wood's report on Crewe and Wolverton engines, 106
 McConnell, Mr., 83, 104, 216, 219
 McIntosh, Mr., 227
 Mersey engines, 160, 253
 Middleton Railway, 7
 Midland engines, 114, 201; goods, 116, 131; mineral, 126; tank, 117; "single," 161, 183; coupled, 134, 169; gradients, 163
 Midland and Great Northern, 181
 Motion, theory of, 249

NEILSON & Co., engines built by, 113, 118, 121
 Newcastle and Carlisle engines, 64
 New York Central, 190
 Nicholson, Mr. John, 45
 "Nine-ninety-nine," 190
 North-Eastern engines, 147, 148, 180, 229
 North British engines, 160, 225
 North London engines, 156, 182
 North Midland engines, 84

PARK, Mr., designs for North London engines, 156
 Pearson, Mr., designs, 107, 217
 Pennsylvania engines, 194
 Philadelphia and Reading engines, 194, 196
 Pollitt, Mr., designs for Manchester, Sheffield, and Lincolnshire engines, 183, 223
 Pryce, Mr., designs for North London Engines, 182

RAILWAY race, 137, 139
 Railway speed, table of, 266
 Ramsbottom, Mr. John, 109
 Reversing by steam, 123; by air, 129

SAND blast, 255
 Sharp, Roberts & Co., 54, 70, 203
 Sharp Brothers, 213
 Sharp, Stewart & Co., 169, 181
 South-Eastern engines, 154
 South Kensington Museum, engines preserved at: "Rocket," 31; "Sanspareil," 34; "Agenoria," 29; "Puffing Billy," 10
 Speed table, 266.
 Speed, high, 99, 101, 193
 Steam springs, 14
 "Stevens," The, 189
 Stephenson, Mr. George, first engine, 13; Hetton engines, 18; engineer, Stockton and Darlington line, 19; drove "Northumbrian," 35; the "Comet," 44; the "Stephenson," 42
 Stephenson & Co., engines by, 19, 23, 27, 30, 38, 59; "Standard," 67

- Stirling, Mr. P., engines for
Great Northern Railway, 138,
182
- Stirling, Mr. James, 122, 154
- Stirling & Co., 78
- Stockton and Darlington Railway
opened, 19; engines, 21
- Sturrock, 107, 216, 221
- Stroudley engines by, 124,
129
- T**ABLE of speeds, 266; of
Great Western Railway
first locomotives, *facing* 73
- Tank engine, 68 tons, 160.
- Tayleur & Co., 65, 202
- Ten-foot wheels, 76, 206
- Ten-wheeled engines, 236
- Tenders. bogie, 241
- Theory of motion, 197
- Three-cylinder engines, 93, 240
- Thunderer, 206
- Trevithick, Mr. R., 5
- Trevithick, Mr. F., 99
- Tulk and Ley, Messrs., 92, 98
- U**NION Foundry, Bolton, 107
- V**ALVE-GEAR, ancient, 45;
Forrester's, 63; Hawthorn's,
65; Roberts's, 54; Haigh
Foundry, 80; Howe's, 87;
Joy's, 263
- Vauclain Compound, 193, 195
- "Velocipede," 100
- Vortex blast pipe, 152
- "Vulcan" (Leicester and Swan-
nington), 66
- "Vulcan" (Great Western), 201
- Vulcan Foundry, 65, 202
- W**EATHERBURN, Mr., 44
- Webb, Mr., designs, 165,
186, 234; an impartial trial
necessary, 128
- Westinghouse brake on Brighton
engines, 129, 138; on Cale-
donian engines, 229
- Westinghouse "quick-acting"
brake, 229
- Whistle, the first steam, 52
- Winby's design, a failure, 181
- Wilson, E. B. & Co., engines by,
98, 212
- Wolverton, engines built at, 105,
111, 219
- Worsdell, Mr. W., designs for
North-Eastern Engines, 148,
180, 229, 238
- Worsdell, Mr. T. W., 147

CROSBY LOCKWOOD & SON'S

Catalogue of

Scientific, Technical and

Industrial Books.

	PAGE		PAGE
MECHANICAL ENGINEERING	1	CARPENTRY & TIMBER	28
CIVIL ENGINEERING	10	DECORATIVE ARTS	80
MARINE ENGINEERING, &c.	17	NATURAL SCIENCE	82
MINING & METALLURGY	19	CHEMICAL MANUFACTURES	84
COLLIERY WORKING, &c.	21	INDUSTRIAL ARTS	86
ELECTRICITY	28	COMMERCE, TABLES, &c.	41
ARCHITECTURE & BUILDING	25	AGRICULTURE & GARDENING	43
SANITATION & WATER SUPPLY	27	AUCTIONEERING, VALUING, &c.	46
		LAW & MISCELLANEOUS.	47

MECHANICAL ENGINEERING, &c.

THE MECHANICAL ENGINEER'S POCKET-BOOK.

Comprising Tables, Formulæ, Rules, and Data: A Handy Book of Reference for Daily Use in Engineering Practice. By D. KINNEAR CLARK, M. Inst. C.E., Fourth Edition. Small 8vo, 700 pp., bound in flexible Leather Cover, rounded corners 6/0

SUMMARY OF CONTENTS:—MATHEMATICAL TABLES.—MEASUREMENT OF SURFACES AND SOLIDS.—ENGLISH AND FOREIGN WEIGHTS AND MEASURES.—MONEYS.—SPECIFIC GRAVITY, WEIGHT, AND VOLUME.—MANUFACTURED METALS.—STEEL PIPES.—BOLTS AND NUTS.—SUNDRY ARTICLES IN WROUGHT AND CAST IRON, COPPER, BRASS, LEAD, TIN, ZINC.—STRENGTH OF TIMBER.—STRENGTH OF CAST IRON.—STRENGTH OF WROUGHT IRON.—STRENGTH OF STEEL.—TENSILE STRENGTH OF COPPER, LEAD, &c.—RESISTANCE OF STONES AND OTHER BUILDING MATERIALS.—RIVETED JOINTS IN BOILER PLATES.—BOILER SHELLS.—WIRE ROPES AND HEMP ROPES.—CHAINS AND CHAIN CABLES.—FRAMING.—HARDNESS OF METALS, ALLOYS, AND STONES.—LABOUR OF ANIMALS.—MECHANICAL PRINCIPLES.—GRAVITY AND FALL OF BODIES.—ACCELERATING AND RETARDING FORCES.—MILL GEARING, SHAFTING, &c.—TRANSMISSION OF MOTIVE POWER.—HEAT.—COMBUSTION: FUELS.—WARMING, VENTILATION, COOKING STOVES.—STEAM.—STEAM ENGINES AND BOILERS.—RAILWAYS.—TEAMWAYS.—TEAM SHIPS.—PUMPING STEAM ENGINES AND PUMPS.—COAL GAS, GAS ENGINES, &c.—AIR IN MOTION.—COMPRESSED AIR.—HOT AIR ENGINES.—WATER POWER.—SPEED OF CUTTING TOOLS.—COLOURS.—ELECTRICAL ENGINEERING.

"Mr. Clark manifests what is an innate perception of what is likely to be useful in a pocket-book, and he is really unrivalled in the art of condensation. It is very difficult to hit upon any mechanical engineering subject concerning which this work supplies too information, and the excellent index at the end adds to its utility. In one word, it is an exceedingly handy and efficient tool, possessed of which the engineer will be saved many a wearisome calculation, or yet more wearisome hunt through various text-books and treatises, and, as such, we can heartily recommend it to our readers."—*The Engineer*.

"It would be found difficult to compress more matter within a similar compass, or produce a book of 650 pages which should be more compact or convenient for pocket reference. . . . Will be appreciated by mechanical engineers of all classes."—*Practical Engineer*.

MR. HUTTON'S PRACTICAL HANDBOOKS.

THE WORKS' MANAGER'S HANDBOOK.

Comprising Modern Rules, Tables, and Data. For Engineers, Millwrights, and Boiler Makers; Tool Makers, Machinists, and Metal Workers; Iron and Brass Founders, &c. By W. S. HUTTON, Civil and Mechanical Engineer, Author of "The Practical Engineer's Handbook." Sixth Edition, carefully Revised, with Additions. In One handsome Volume, medium 8vo, strongly bound. [Just Published. 18/0

The Author having compiled Rules and Data for his own use in a great variety of modern engineering work, and having found his notes extremely useful, decided to publish them—revised to date—believing that a practical work, suited to the DAILY REQUIREMENTS of MODERN ENGINEERS, would be favourably received.

"Of this edition we may repeat the appreciative remarks we made upon the first and third. Since the appearance of the latter very considerable modifications have been made, although the total number of pages remains almost the same. It is a very useful collection of rules, tables, and workshop and drawing office data."—*The Engineer*, May 20, 1895.

"The author treats every subject from the point of view of one who has collected workshop notes for application in workshop practice, rather than from the theoretical or literary aspect. The volume contains a great deal of that kind of information which is gained only by practical experience, and is seldom written in books."—*The Engineer*, June 5, 1885.

"The volume is an exceedingly useful one, bristling with engineer's notes, memoranda, and rules, and well worthy of being on every mechanical engineer's bookshelf."—*Mechanical World*.

"The information is precisely that likely to be required in practice. . . . The work forms a desirable addition to the library not only of the works' manager, but of any one connected with general engineering."—*Mining Journal*.

"Brilliant of useful information, stated in a concise form, Mr. Hutton's books have met a pressing want among engineers. The book must prove extremely useful to every practical man possessing a copy."—*Practical Engineer*.

THE PRACTICAL ENGINEER'S HANDBOOK.

Comprising a Treatise on Modern Engines and Boilers, Marine, Locomotive, and Stationary. And containing a large collection of Rules and Practical Data relating to Recent Practice in Designing and Constructing all kinds of Engines, Boilers, and other Engineering work. The whole constituting a comprehensive Key to the Board of Trade and other Examinations for Certificates of Competency in Modern Mechanical Engineering. By WALTER S. HUTTON, Civil and Mechanical Engineer, Author of "The Works' Manager's Handbook for Engineers," &c. With upwards of 420 Illustrations. Sixth Edition, Revised and Enlarged. Medium 8vo, 560 pp., strongly bound.

[Just Published. 18/0

This Work is designed as a companion to the Author's "WORKS' MANAGER'S HANDBOOK." It possesses many new and original features, and contains, like its predecessor, a quantity of matter not originally intended for publication but collected by the Author for his own use in the construction of a great variety of MODERN ENGINEERING WORK.

The information is given in a condensed and concise form, and is illustrated by upwards of 420 Illustrations; and comprises a quantity of tabulated matter of great value to all engaged in designing, constructing, or estimating for ENGINES, BOILERS, and OTHER ENGINEERING WORK.

"We have kept it at hand for several weeks, referring to it as occasion arose, and we have not on a single occasion consulted its pages without finding the information of which we were in quest."—*Advertiser*.

"A thoroughly good practical handbook, which no engineer can go through without learning something that will be of service to him."—*Marine Engineer*.

"An excellent book of reference for engineers, and a valuable text-book for students of engineering."—*Scotsman*.

"This valuable manual embodies the results and experience of the leading authorities on mechanical engineering."—*Building News*.

"The author has collected together a surprising quantity of rules and practical data, and has shown much judgment in the selections he has made. . . . There is no doubt that this book is one of the most useful of its kind published, and will be a very popular compendium."—*Engineer*.

"A mass of information set down in simple language, and in such a form that it can be easily referred to at any time. The matter is uniformly good and well chosen, and is greatly elucidated by the illustrations. The book will find its way on to most engineers' shelves, where it will rank as one of the most useful books of reference."—*Practical Engineer*.

"Full of useful information, and should be found on the office shelf of all practical engineers."—*English Mechanic*.

MR. HUTTON'S PRACTICAL HANDBOOKS—continued.

STEAM BOILER CONSTRUCTION.

A Practical Handbook for Engineers, Boiler-Makers, and Steam Users. Containing a large Collection of Rules and Data relating to Recent Practice in the Design, Construction, and Working of all Kinds of Stationary, Locomotive, and Marine Steam-Boilers. By WALTER S. HUTTON, Civil and Mechanical Engineer, Author of "The Works' Manager's Handbook," "The Practical Engineer's Handbook," &c. With upwards of 500 Illustrations. Third Edition, Revised and much Enlarged, medium 8vo, cloth . . . 18/0

THIS WORK is issued in continuation of the Series of Handbooks written by the Author, viz. :—"THE WORKS' MANAGER'S HANDBOOK" and "THE PRACTICAL ENGINEER'S HANDBOOK," which are so highly appreciated by engineers for the practical nature of their information; and is consequently written in the same style as those works.

The Author believes that the concentration, in a convenient form for easy reference, of such a large amount of thoroughly practical information on Steam-Boilers, will be of considerable service to those for whom it is intended, and he trusts the book may be deemed worthy of as favourable a reception as has been accorded to its predecessors.

"One of the best, if not the best, books on boilers that has ever been published. The information is of the right kind, in a simple and accessible form. So far as generation is concerned, this is, undoubtedly, the standard book on steam practice."—*Electrical Review*.

"Every detail, both in boiler design and management, is clearly laid before the reader. The volume shows that boiler construction has been reduced to the condition of one of the most exact sciences; and such a book is of the utmost value to the *fin de siècle* Engineer and Works Manager."—*Marine Engineer*.

"There has long been room for a modern handbook on steam boilers; there is not that room now, because Mr. Hutton has filled it. It is a thoroughly practical book for those who are occupied in the construction, design, selection, or use of boilers."—*Engineer*.

"The book is of so important and comprehensive a character that it must find its way into the libraries of every one interested in boiler using or boiler manufacture if they wish to be thoroughly informed. We strongly recommend the book for the intrinsic value of its contents."—*Machinery Market*.

PRACTICAL MECHANICS' WORKSHOP COMPANION.

Comprising a great variety of the most useful Rules and Formulæ in Mechanical Science, with numerous Tables of Practical Data and Calculated Results for Facilitating Mechanical Operations. By WILLIAM TEMPLETON, Author of "The Engineer's Practical Assistant," &c., &c. Eighteenth Edition, Revised, Modernised, and considerably Enlarged by WALTER S. HUTTON, C.E., Author of "The Works' Manager's Handbook," "The Practical Engineer's Handbook," &c. Fcap. 8vo, nearly 500 pp., with 8 Plates and upwards of 250 Illustrative Diagrams, strongly bound for workshop or pocket wear and tear. 6/0

"In its modernised form Hutton's 'Templeton' should have a wide sale, for it contains much valuable information which the mechanic will often find of use, and not a few tables and notes which he might look for in vain in other works. This modernised edition will be appreciated by all who have learned to value the original editions of 'Templeton.'"—*English Mechanic*.

"It has met with great success in the engineering workshop, as we can testify; and there are a great many men who, in a great measure, owe their rise in life to this little book."—*Building News*.

"This familiar text-book—well known to all mechanics and engineers—is of essential service to the every-day requirements of engineers, millwrights, and the various trades connected with engineering and building. The new modernised edition is worth its weight in gold."—*Building News*. (Second Notice.)

"This well-known and largely-used book contains information, brought up to date, of the sort so useful to the foreman and draughtsman. So much fresh information has been introduced as to constitute it practically a new book. It will be largely used in the office and workshop."—*Mechanical World*.

"The publishers wisely entrusted the task of revision of this popular, valuable, and useful book to Mr. Hutton, than whom a more competent man they could not have found."—*Iron*.

ENGINEER'S AND MILLWRIGHT'S ASSISTANT.

A Collection of Useful Tables, Rules, and Data. By WILLIAM TEMPLETON. Eighth Edition, with Additions. 18mo, cloth 2/6

"Occupies a foremost place among books of this kind. A more suitable present to an apprentice to any of the mechanical trades could not possibly be made."—*Building News*.

"A deservedly popular work. It should be in the 'drawer' of every mechanic."—*English Mechanic*.

THE MECHANICAL ENGINEER'S REFERENCE BOOK.

For Machine and Boiler Construction. In Two Parts. Part I. GENERAL ENGINEERING DATA. Part II. BOILER CONSTRUCTION. With 51 Plates and numerous Illustrations. By NELSON FOLEY, M.I.N.A. Second Edition, Revised throughout and much Enlarged. Folio, half-bound, net . £3 3s.

PART I.—MEASURES.—CIRCUMFERENCES AND AREAS, &c., SQUARES, CUBES, FOURTH POWERS.—SQUARE AND CUBE ROOTS.—SURFACE OF TUBES.—RECIPROALS.—LOGARITHMS.—MENSURATION.—SPECIFIC GRAVITIES AND WEIGHTS.—WORK AND POWER.—HEAT.—COMBUSTION.—EXPANSION AND CONTRACTION.—EXPANSION OF GASES.—STEAM.—STATIC FORCES.—GRAVITATION AND ATTRACTION.—MOTION AND COMPUTATION OF RESULTING FORCES.—ACCUMULATED WORK.—CENTRE AND RADIUS OF GYRATION.—MOMENT OF INERTIA.—CENTRE OF OSCILLATION.—ELECTRICITY.—STRENGTH OF MATERIALS.—ELASTICITY.—TEST SHEETS OF METALS.—FRICTION.—TRANSMISSION OF POWER.—FLOW OF LIQUIDS.—FLOW OF GASES.—AIR PUMPS, SURFACE CONDENSERS, &c.—SPREAD OF STEAMSHIPS.—PROPELLERS.—CUTTING TOOLS.—FLANGES.—COPPER SHEETS AND TUBES.—SCREWS, NUTS, BOLT HEADS, &c.—VARIOUS RECIPES AND MISCELLANEOUS MATTER.—WITH DIAGRAMS FOR VALVE-GEAR, BELTING AND ROPES, DISCHARGE AND SUCTION PIPES, SCREW PROPELLERS, AND COPPER PIPES.

PART II.—TREATING OF POWER OF BOILERS.—USEFUL RATIOS.—NOTES ON CONSTRUCTION.—CYLINDRICAL BOILER SHELLS.—CIRCULAR FURNACES.—FLAT PLATES.—STAYS.—GIRDERS.—SCREWS.—HYDRAULIC TESTS.—RIVETING.—BOILER SETTING, CHIMNEYS, AND MOUNTINGS.—FURLS, &c.—EXAMPLES OF BOILERS AND SPREADS OF STEAMSHIPS.—NOMINAL AND NORMAL HORSE POWER.—WITH DIAGRAMS FOR ALL BOILER CALCULATIONS AND DRAWINGS OF MANY VARIETIES OF BOILERS.

"Mr. Foley is well fitted to compile such a work. . . . The diagrams are a great feature of the work. . . . Regarding the whole work, it may be very fairly stated that Mr. Foley has produced a volume which will undoubtedly fulfil the desire of the author and become indispensable to all mechanical engineers."—*Marine Engineer*.

"We have carefully examined this work, and pronounce it a most excellent reference book for the use of marine engineers."—*Journal of American Society of Naval Engineers*.

COAL AND SPEED TABLES.

A Pocket Book for Engineers and Steam Users. By NELSON FOLEY, Author of "The Mechanical Engineer's Reference Book." Pocket-size, cloth . 3/6

TEXT-BOOK ON THE STEAM ENGINE.

With a Supplement on GAS ENGINES, and PART II. ON HEAT ENGINES. By T. M. GOODEVE, M.A., Barrister-at-Law, Professor of Mechanics at the Royal College of Science, London; Author of "The Principles of Mechanics," "The Elements of Mechanism," &c. Fourteenth Edition. Crown 8vo, cloth . 6/0

"Professor Goodeve has given us a treatise on the steam engine which will bear comparison with anything written by Huxley or Maxwell, and we can award it no higher praise."—*Engineer*.

ON GAS ENGINES.

With Appendix describing a Recent Engine with Tube Igniter. By T. M. GOODEVE, M.A. Crown 8vo, cloth . 2/6

"Like all Mr. Goodeve's writings, the present is no exception in point of general excellence. It is a valuable little volume."—*Mechanical World*.

THE GAS-ENGINE HANDBOOK.

A Manual of Useful Information for the Designer and the Engineer. By E. W. ROBERTS, M.E. With Forty Full-page Engravings. Small Fcap. 8vo, leather. [Just Published. Net 8/6

A TREATISE ON STEAM BOILERS.

Their Strength, Construction, and Economical Working. By R. WILSON, C.E. Fifth Edition. 12mo, cloth . 6/0

"The best treatise that has ever been published on steam boilers."—*Engineer*.

"The author shows himself perfect master of his subject, and we heartily recommend all employing steam power to possess themselves of the work."—*Kyland's Iron Trade Circular*.

THE MECHANICAL ENGINEER'S COMPANION

of Areas, Circumferences, Decimal Equivalents, in inches and feet, millimetres, squares, cubes, roots, &c.; Weights, Measures, and other Data. Also Practical Rules for Modern Engine Proportions. By R. EDWARDS, M.Inst.C.E. Fcap. 8vo, cloth. [Just Published. 3/6

"A very useful little volume. It contains many tables, classified data and memoranda generally useful to engineers."—*Engineer*.

"What it professes to be, 'a handy office companion,' giving in a succinct form, a variety of information likely to be required by engineers in their everyday office work."—*Nature*.

A HANDBOOK ON THE STEAM ENGINE.

With especial Reference to Small and Medium-sized Engines. For the Use of Engine Makers, Mechanical Draughtsmen, Engineering Students, and users of Steam Power. By HERMAN HÆDER, C.E. Translated from the German with considerable additions and alterations, by H. H. P. POWLES, A.M.I.C.E., M.I.M.E. Second Edition, Revised. With nearly 1,100 Illustrations. Crown 8vo, cloth 9/0

"A perfect encyclopædia of the steam engine and its details, and one which must take a permanent place in English drawing-offices and workshops."—*A Foreman Pattern-maker.*

"This is an excellent book, and should be in the hands of all who are interested in the construction and design of medium-sized stationary engines. . . . A careful study of its contents and the arrangement of the sections leads to the conclusion that there is probably no other book like it in this country. The volume aims at showing the results of practical experience, and it certainly may claim a complete achievement of this idea."—*Nature.*

BOILER AND FACTORY CHIMNEYS.

Their Draught-Power and Stability. With a chapter on *Lightning Conductors.* By ROBERT WILSON, A.I.C.E., Author of "A Treatise on Steam Boilers," &c. Crown 8vo, cloth 3/6

"A valuable contribution to the literature of scientific building."—*The Builder.*

BOILER MAKER'S READY RECKONER & ASSISTANT.

With Examples of Practical Geometry and Templating, for the Use of Platers, Smiths, and Riveters. By JOHN COURTNEY, Edited by D. K. CLARK, M.I.C.E. Third Edition, 480 pp., with 140 Illustrations. Fcap. 8vo . 7/0

"No workman or apprentice should be without this book."—*Iron Trade Circular.*

REFRIGERATION, COLD STORAGE, & ICE-MAKING:

A Practical Treatise on the Art and Science of Refrigeration. By A. J. WALLIS-TAYLER, A.M.Inst.C.E., Author of "Refrigerating and Ice-Making Machinery." 600 pp., with 360 Illustrations. Medium 8vo, cloth.

[Just Published. Net 15/0

"The author has to be congratulated on the completion and production of such an important work and it cannot fail to have a large body of readers, for it leaves out nothing that would in any way be of value to those interested in the subject."—*Steamship.*

"No one whose duty it is to handle the mammoth preserving installations of these latter days can afford to be without this valuable book."—*Glasgow Herald.*

THE POCKET BOOK OF REFRIGERATION AND ICE-MAKING FOR 1902.

Edited by A. J. WALLIS-TAYLER, A.M.Inst.C.E. Author of "Refrigerating and Ice-making Machinery," &c. With Diary and Almanac. Small Crown 8vo, cloth.

[Just Published. Net 2/6

REFRIGERATING & ICE-MAKING MACHINERY.

A Descriptive Treatise for the Use of Persons Employing Refrigerating and Ice-Making Installations, and others. By A. J. WALLIS-TAYLER, A.M. Inst. C.E. Third Edition, Revised and Enlarged. With Illustrations. Crown 8vo, cloth.

[Just Published. 7/6

"Practical, explicit, and profusely illustrated."—*Glasgow Herald.*

"We recommend the book, which gives the cost of various systems and illustrations showing details of parts of machinery and general arrangements of complete installations."—*Builder.*

"May be recommended as a useful description of the machinery, the processes, and of the facts, figures, and tabulated physics of refrigerating. It is one of the best compilations on the subject."—*Engineer.*

TEA MACHINERY AND TEA FACTORIES.

A Descriptive Treatise on the Mechanical Appliances required in the Cultivation of the Tea Plant and the Preparation of Tea for the Market. By A. J. WALLIS-TAYLER, A.M. Inst. C.E. Medium 8vo, 468 pp. With 218 Illustrations.

[Just Published. Net 25/0

"When tea planting was first introduced into the British possessions little, if any, machinery was employed, but now its use is almost universal. This volume contains a very full account of the machinery necessary for the proper outfit of a factory, and also a description of the processes best carried out by this machinery."—*Journal Society of Arts.*

ENGINEERING ESTIMATES, COSTS, AND ACCOUNTS.

A Guide to Commercial Engineering. With numerous examples of Estimates and Costs of Millwright Work, Miscellaneous Productions, Steam Engines and Steam Boilers; and a Section on the Preparation of Costs Accounts. By A GENERAL MANAGER. Second Edition. 8vo, cloth. [*Just Published.*] 12/0

"This is an excellent and very useful book, covering subject-matter in constant requisition in every factory and workshop. . . . The book is invaluable, not only to the young engineer, but also to the estimate department of every works."—*Builder.*

"We accord the work unqualified praise. The information is given in a plain, straightforward manner, and bears throughout evidence of the intimate practical acquaintance of the author with every phase of commercial engineering."—*Mechanical World.*

AERIAL OR WIRE-ROPE TRAMWAYS.

Their Construction and Management. By A. J. WALLIS-TAYLER, A.M.Inst.C.E. With 81 Illustrations. Crown 8vo, cloth. [*Just Published.*] 7/6

"This is in its way an excellent volume. Without going into the minutiae of the subject, it yet lays before its readers a very good exposition of the various systems of rope transmission in use, and gives as well not a little valuable information about their working, repair, and management. We can safely recommend it as a useful general treatise on the subject."—*The Engineer.*

MOTOR CARS OR POWER-CARRIAGES FOR COMMON ROADS.

By A. J. WALLIS-TAYLER, Assoc. Memb. Inst. C.E., Author of "Modern Cycles," &c. 212 pp., with 76 Illustrations. Crown 8vo, cloth . . . 4/8

"Mr. Wallis-Taylor's book is a welcome addition to the literature of the subject, as it is the production of an Engineer, and has not been written with a view to assist in the promotion of companies. . . . The book is clearly expressed throughout, and is just the sort of work that an engineer, thinking of turning his attention to motor-carriage work, would do well to read as a preliminary to starting operations."—*Engineering.*

PLATING AND BOILER MAKING.

A Practical Handbook for Workshop Operations. By JOSEPH G. HORNER, A.M.I.M.E. 380 pp. with 338 Illustrations. Crown 8vo, cloth . . . 7/6

"The latest production from the pen of this writer is characterised by that evidence of close acquaintance with workshop methods which will render the book exceedingly acceptable to the practical hand. . . . A practical handbook on a subject which has not hitherto received much attention from those qualified to deal with it in a satisfactory manner."—*Mechanical World.*

PATTERN MAKING.

A Practical Treatise, embracing the Main Types of Engineering Construction, and including Gearing, both Hand and Machine-made, Engine Work, Sheaves and Pulleys, Pipes and Columns, Screws, Machine Parts, Pumps and Cocks, and the Moulding of Patterns in Loam and Greensand, &c., together with the methods of estimating the weight of Castings; with an Appendix of Tables for Workshop Reference. By JOSEPH G. HORNER, A.M.I.M.E. Third Edition, Enlarged. With 486 Illustrations. Crown 8vo, cloth . . . Net 7/6

"A well-written technical guide, evidently written by a man who understands and has practised what he has written about. . . . We cordially recommend it to engineering students, young journeymen, and others desirous of being initiated into the mysteries of pattern-making."—*Builder.*

"An excellent *vade mecum* for the apprentice who desires to become master of his trade."—*English Mechanic.*

MECHANICAL ENGINEERING TERMS

(Lockwood's Dictionary of). Embracing those current in the Drawing Office, Pattern Shop, Foundry, Fitting, Turning, Smiths', and Boiler Shops, &c. Comprising upwards of 6,000 Definitions. Edited by J. G. HORNER, A.M.I.M.E. Third Edition, Revised. Crown 8vo, cloth . . . Net 7/6

"Just the sort of handy dictionary required by the various trades engaged in mechanical engineering. The practical engineering pupil will find the book of great value in his studies, and every foreman engineer and mechanic should have a copy."—*Building News.*

TOOTHED GEARING.

A Practical Handbook for Offices and Workshops. By JOSEPH HORNER, A.M.I.M.E. With 184 Illustrations. Crown 8vo, cloth . . . 6/0

"We must give the book our unqualified praise for its thoroughness of treatment, and we can heartily recommend it to all interested as the most practical book on the subject yet written."—*Mechanical World.*

FIRES, FIRE-ENGINES, AND FIRE BRIGADES.

With a History of Fire-Engines, their Construction, Use, and Management; Foreign Fire Systems; Hints on Fire-Brigades, &c By CHARLES F. T. YOUNG, C.E. 8vo, cloth . . . £1 4s.

"To such of our readers as are interested in the subject of fires and fire apparatus we can most heartily commend this book."—*Engineering.*

AËRIAL NAVIGATION.

A Practical Handbook on the Construction of Dirigible Balloons, Aërostats, Aërop'anes, and Aëromotors. By FREDERICK WALKER, C.E., Associate Member of the Aëronautic Institute. With 104 Illustrations. Large Crown 8vo, cloth. [Just Published, Net. 7/6

STONE-WORKING MACHINERY.

A Manual dealing with the Rapid and Economical Conversion of Stone. With Hints on the Arrangement and Management of Stone Works. By M. POWIS BALE, M.I.M.E. Second Edition, enlarged. Crown 8vo, cloth . . . 9/0

"Should be in the hands of every mason or student of stonework."—*Colliery Guardian*.

"A capital handbook for all who manipulate stone for building or ornamental purposes."—*Machinery Market*.

PUMPS AND PUMPING.

A Handbook for Pump Users. Being Notes on Selection, Construction, and Management. By M. POWIS BALE, M.I.M.E. Fourth Edition. Crown 8vo, cloth. [Just Published. 3/6

"The matter is set forth as concisely as possible. In fact, condensation rather than diffuseness has been the author's aim throughout; yet he does not seem to have omitted anything likely to be of use."—*Journal of Gas Lighting*.

MILLING MACHINES AND PROCESSES.

A Practical Treatise on Shaping Metals by Rotary Cutters. Including Information on Making and Grinding the Cutters. By PAUL N. HASLUCK, Author of "Lathe-Work." 352 pp. With upwards of 300 Engravings. Large crown 8vo, cloth . . . 12/6

"A new departure in engineering literature. . . . We can recommend this work to all interested in milling machines; it is what it professes to be—a practical treatise."—*Engineer*.

"A capital and reliable book which will no doubt be of considerable service both to those who are already acquainted with the process as well as to those who contemplate its adoption."—*Industries*.

LATHE-WORK.

A Practical Treatise on the Tools, Appliances, and Processes employed in the Art of Turning. By P. N. HASLUCK. Seventh Edition. Crown 8vo. 5/0

"Written by a man who knows not only how work ought to be done, but who also knows how to do it, and how to convey his knowledge to others. To all turners this book would be valuable."—*Engineering*.

"We can safely recommend the work to young engineers. To the amateur it will simply be invaluable. To the student it will convey a great deal of useful information."—*Engineer*.

SCREW-THREADS,

And Methods of Producing Them. With numerous Tables and complete Directions for using Screw-Cutting Lathes. By PAUL N. HASLUCK, Author of "Lathe-Work," &c. Fifth Edition. Waistcoat-pocket size . . . 1/6

"Full of useful information, hints and practical criticism. Taps, dies, and screwing tools generally are illustrated and their actions described."—*Mechanical World*.

"It is a complete compendium of all the details of the screw-cutting lathe; in fact a *mutuum in parvo* on all the subjects it treats upon."—*Carpenter and Builder*.

TABLES AND MEMORANDA FOR ENGINEERS, MECHANICS, ARCHITECTS, BUILDERS, &c.

Selected and Arranged by FRANCIS SMITH. Sixth Edition, Revised, including ELECTRICAL TABLES, FORMULÆ, and MEMORANDA. Waistcoat-pocket size, limp leather. [Just Published. 1/6

"It would, perhaps, be as difficult to make a small pocket-book selection of notes and formulae to suit ALL engineers as it would be to make a universal medicine; but Mr. Smith's waistcoat-pocket collection may be looked upon as a successful attempt."—*Engineer*.

"The best example we have ever seen of 270 pages of useful matter packed into the dimensions of a card-case."—*Building News*. "A veritable pocket treasury of knowledge."—*Iron*.

POCKET GLOSSARY OF TECHNICAL TERMS.

English-French, French-English; with Tables suitable for the Architectural, Engineering, Manufacturing, and Nautical Professions. By JOHN JAMES FLETCHER. Third Edition, 200 pp. Waistcoat-pocket size, leather . . . 1/6

"It is a very great advantage for readers and correspondents in France and England to have so large a number of the words relating to engineering and manufacturers collected in a slipshod volume. The little book will be useful both to students and travellers."—*Architect*.

"The glossary of terms is very complete, and many of the Tables are new and well arranged. We cordially commend the book."—*Mechanical World*.

THE ENGINEER'S YEAR BOOK FOR 1902.

Comprising Formulae, Rules, Tables, Data and Memoranda in Civil, Mechanical, Electrical, Marine and Mine Engineering. By H. R. KEMPE, A.M. Inst. C.E., M.I.E.E., Principal Technical Officer, Engineer-in-Chief's Office, General Post Office, London, Author of "A Handbook of Electrical Testing," "The Electrical Engineer's Pocket-Book," &c. With 1,000 Illustrations, specially Engraved for the work. Crown 8vo, 900 pp., leather. [Just Published. 8/0

"Kempe's Year Book really requires no commendation. Its sphere of usefulness is widely known, and it is used by engineers the world over."—*The Engineer*.

"The volume is distinctly in advance of most similar publications in this country."—*Engineering*.

"This valuable and well-designed book of reference meets the demands of all descriptions of engineers."—*Saturday Review*.

"Teems with up-to-date information in every branch of engineering and construction."—*Building News*.

"The needs of the engineering profession could hardly be supplied in a more admirable, complete and convenient form. To say that it more than sustains all comparisons is praise of the highest sort, and that may justly be said of it."—*Mining Journal*.

"There is certainly room for the newcomer, which supplies explanations and directions, as well as formulae and tables. It deserves to become one of the most successful of the technical manuals."—*Architect*.

"Brings together with great skill all the technical information which an engineer has to use day by day. It is in every way admirably equipped, and is sure to prove successful."—*Scottsman*.

"The up-to-dateness of Mr. Kempe's compilation is a quality that will not be lost on the busy people for whom the work is intended."—*Glasgow Herald*.

THE PORTABLE ENGINE.

A Practical Manual on its Construction and Management. For the use of Owners and Users of Steam Engines generally. By WILLIAM DYSON WANSBROUGH. Crown 8vo, cloth 3/6

"This is a work of value to those who use steam machinery. . . . Should be read by every one who has a steam engine, on a farm or elsewhere."—*Mark Lane Express*.

"We cordially commend this work to buyers and owners of steam-engines, and to those who have to do with their construction or use."—*Timber Trades Journal*

"Such a general knowledge of the steam-engine as Mr. Wansbrough furnishes to the reader should be acquired by all intelligent owners and others who use the steam-engine."—*Building News*.

"An excellent text-book of this useful form of engine. The 'Hints to Purchasers' contain a good deal of common-sense and practical wisdom."—*English Mechanic*.

STATIONARY STEAM ENGINES.

Their Care and Management. By CHARLES HURST, Author of "Valves and Valve Gearing" Crown 8vo. [In the press.

IRON AND STEEL.

A Work for the Forge, Foundry, Factory, and Office. Containing ready, useful, and trustworthy information for Ironmasters and their Stock-takers; Managers of Bar, Rail, Plate, and Sheet Rolling Mills; Iron and Metal Founders; Iron Ship and Bridge Builders; Mechanical, Mining, and Consulting Engineers; Architects, Contractors, Builders, &c. By CHARLES HOARE, Author of "The Slide Rule," &c. Ninth Edition. 32mo, leather . . . 8/0

"For comprehensiveness the book has not its equal."—*Iron*.

"One of the best of the pocket books."—*English Mechanic*.

CONDENSED MECHANICS.

A Selection of Formulæ, Rules, Tables, and Data for the Use of Engineering Students, &c. By W. G. C. HUGHES, A.M.I.C.E. Crown 8vo, cloth . . . 2/6

"The book is well fitted for those who are either confronted with practical problems in their work, or are preparing for examination and wish to refresh their knowledge by going through their formulæ again."—*Marine Engineer*.

THE SAFE USE OF STEAM.

Containing Rules for Unprofessional Steam Users. By an ENGINEER. Seventh Edition. Sewed 6d.

"If steam-users would but learn this little book by heart, boiler explosions would become sensations by their rarity."—*English Mechanic*.

THE LOCOMOTIVE ENGINE.

The Autobiography of an Old Locomotive Engine. By ROBERT WEATHERBURN, M.I.M.E. With Illustrations and Portraits of GEORGE and ROBERT STEPHENSON. Crown 8vo, cloth. [Just Published. Net 2/6]

SUMMARY OF CONTENTS:—PROLOGUE.—CYLINDERS.—MOTIONS.—CONNECTING RODS.—FRAMES.—WHEELS.—PUMPS, CLACKS, &c.—INJECTORS.—BOILERS.—SMOKE BOX.—CHIMNEY.—WEATHER BOARD AND AWNING.—INTERNAL DISSENSIONS.—ENGINE DRIVERS, &c.

"It would be difficult to imagine anything more ingeniously planned, more cleverly worked out, and more charmingly written. Readers cannot fail to find the volume most enjoyable."—*Glasgow Herald*.

THE LOCOMOTIVE ENGINE AND ITS DEVELOPMENT.

A Popular Treatise on the Gradual Improvements made in Railway Engines between 1803 and 1806. By CLEMENT E. STRETTON, C.E. Fifth Edition, Enlarged. With 120 Illustrations. Crown 8vo, cloth. [Just Published. 3/6]

"Students of railway history and all who are interested in the evolution of the modern locomotive will find much to attract and entertain in this volume."—*The Times*.

LOCOMOTIVE ENGINE DRIVING.

A Practical Manual for Engineers in Charge of Locomotive Engines. By MICHAEL REYNOLDS, Member of the Society of Engineers, formerly Locomotive Inspector, L. B. & S. C. R. Eleventh Edition. Including a KEY TO THE LOCOMOTIVE ENGINE. Crown 8vo, cloth 4/6

"Mr. Reynolds has supplied a want, and has supplied it well. We can confidently recommend the book not only to the practical driver, but to everyone who takes an interest in the performance of locomotive engines."—*The Engineer*.

"Mr. Reynolds has opened a new chapter in the literature of the day. His treatise is admirable."—*Athenaeum*.

THE MODEL LOCOMOTIVE ENGINEER,

Fireman, and Engine-Boy. Comprising a Historical Notice of the Pioneer Locomotive Engines and their Inventors. By MICHAEL REYNOLDS. Second Edition, with Revised Appendix. Crown 8vo, cloth. [Just Published. 4/6]

"From the technical knowledge of the author, it will appeal to the railway man of to-day more forcibly than anything written by Dr. Smiles. . . . The volume contains information of a technical kind, and facts that every driver should be familiar with."—*English Mechanic*.

"We should be glad to see this book in the possession of everyone in the kingdom who has ever laid, or is to lay, hands on a locomotive engine."—*Iron*.

CONTINUOUS RAILWAY BRAKES.

A Practical Treatise on the several Systems in Use in the United Kingdom: their Construction and Performance. With copious Illustrations and numerous Tables. By MICHAEL REYNOLDS. 8vo, cloth 9/0

"A popular explanation of the different brakes. It will be of great assistance in forming public opinion, and will be studied with benefit by those who take an interest in the brake."—*English Mechanic*.

STATIONARY ENGINE DRIVING.

A Practical Manual or Engineers in Charge of Stationary Engines. By MICHAEL REYNOLDS. Sixth Edition. Crown 8vo, cloth 4/6

"The author is thoroughly acquainted with his subjects, and his advice on the various points treated is clear and practical. . . . He has produced a manual which is an exceedingly useful one for the class for whom it is specially intended."—*Engineering*.

"Our author leaves no stone unturned. He is determined that his readers shall not only know something about the stationary engine, but all about it."—*Engineer*.

ENGINE-DRIVING LIFE.

Stirring Adventure and Incidents in the Lives of Locomotive Engine-Drivers. By MICHAEL REYNOLDS. Third Edition. Crown 8vo, cloth . 1/6

"Perfectly fascinating. Wilkie Collins's most thrilling conceptions are thrown into the shade by true incidents, endless in their variety, related in every page."—*North British Mail*.

THE ENGINEMAN'S POCKET COMPANION,

And Practical Educator for Enginemen, Boiler Attendants, and Mechanics. By MICHAEL REYNOLDS. With 45 Illustrations and numerous Diagrams. Fourth Edition, Revised. Royal 16mo, strongly bound for pocket wear. 3/6

"This admirable work is well suited to accomplish its object, being the honest workmanship of a competent engineer."—*Glasgow Herald*.

CIVIL ENGINEERING, SURVEYING, &c.

LIGHT RAILWAYS FOR THE UNITED KINGDOM, INDIA, AND THE COLONIES.

A Practical Handbook setting forth the Principles on which Light Railways should be Constructed, Worked, and Financed; and detailing the Cost of Construction, Equipment, Revenue and Working Expenses of Local Railways already established in the above-mentioned countries, and in Belgium, France, Switzerland, &c. By J. C. MACKAY, F.G.S., A.M. Inst. C.E. Illustrated with Plates and Diagrams. Medium 8vo, cloth. [Just Published. 15/0

"Mr. Mackay's volume is clearly and concisely written, admirably arranged, and freely illustrated. The book is exactly what has been long wanted. We recommend it to all interested in the subject. It is sure to have a wide sale."—*Railway News*.

TUNNELLING.

A Practical Treatise. By CHARLES PRELINI, C.E. With additions by CHARLES S. HILL, C.E. Including 150 Diagrams and Illustrations. Royal 8vo, cloth. [Just Published. Net 16/0

PRACTICAL TUNNELLING.

Explaining in detail Setting-out the Works, Shaft-sinking, and Heading-driving, Ranging the Lines and Levelling underground, Sub-Excavating, Timbering and the Construction of the Brickwork of Tunnels, with the amount of Labour required for, and the Cost of, the various portions of the work. By FREDERICK W. SIMMS, M. Inst. C.E. Fourth Edition, Revised and Further Extended, including the most recent (1895) Examples of Sub-aqueous and other Tunnels, by D. KINNEAR CLARK, M. Inst. C.E. Imperial 8vo, with 34 Folding Plates and other Illustrations. Cloth. [Just Published. 22 2s.

"The present (1896) edition has been brought right up to date, and is thus rendered a work to which civil engineers generally should have ready access, and to which engineers who have construction work can hardly afford to be without, but which to the younger members of the profession is invaluable, as from its pages they can learn the state to which the science of tunnelling has attained."—*Railway News*.

"The estimation in which Mr. Simms's book has been held for many years cannot be more truly expressed than in the words of the late Prof. Rankine: 'The best source of information on the subject of tunnels is Mr. F. W. Simms's work on Practical Tunnelling.'"—*Architect*.

THE WATER SUPPLY OF TOWNS AND THE CONSTRUCTION OF WATER-WORKS.

A Practical Treatise for the Use of Engineers and Students of Engineering. By W. K. BURTON, A.M. Inst. C.E., Professor of Sanitary Engineering in the Imperial University, Tokyo, Japan, and Consulting Engineer to the Tokyo Water-works. Second Edition, Revised and Extended. With numerous Plates and Illustrations. Super-royal 8vo, buckram. [Just Published. 25/0

I. INTRODUCTORY.—II. DIFFERENT QUALITIES OF WATER.—III. QUANTITY OF WATER TO BE PROVIDED.—IV. ON ASCERTAINING WHETHER A PROPOSED SOURCE OF SUPPLY IS SUFFICIENT.—V. ON ESTIMATING THE STORAGE CAPACITY REQUIRED TO BE PROVIDED.—VI. CLASSIFICATION OF WATER-WORKS.—VII. IMPOUNDING RESERVOIRS.—VIII. EARTHWORK DAMS.—IX. MASONRY DAMS.—X. THE PURIFICATION OF WATER.—XI. SETTLING RESERVOIRS.—XII. SAND FILTRATION.—XIII. PURIFICATION OF WATER BY ACTION OF IRON, SOFTENING OF WATER BY ACTION OF LIME, NATURAL FILTRATION.—XIV. SERVICE OR CLEAN WATER RESERVOIRS—WATER TOWERS—STAND PIPES.—XV. THE CONNECTION OF SETTLING RESERVOIRS, FILTER BEDS AND SERVICE RESERVOIRS.—XVI. PUMPING MACHINERY.—XVII. FLOW OF WATER IN CONDUITS—PIPES AND OPEN CHANNELS.—XVIII. DISTRIBUTION SYSTEMS.—XIX. SPECIAL PROVISIONS FOR THE EXTINCTION OF FIRE.—XX. PIPES FOR WATER-WORKS.—XXI. PREVENTION OF WASTE OF WATER.—XXII. VARIOUS APPLICATIONS USED IN CONNECTION WITH WATER-WORKS.

APPENDIX I. By PROF. JOHN MILNE, R.S.—CONSIDERATIONS CONCERNING THE PROBABLE EFFECTS OF EARTHQUAKES ON WATER-WORKS, AND THE SPECIAL PRECAUTIONS TO BE TAKEN IN EARTHQUAKE COUNTRIES.

APPENDIX II. By JOHN DE RIJKE, C.E.—ON SAND DUNES AND DUNE SAND AS A SOURCE OF WATER SUPPLY.

"The chapter upon filtration of water is very complete, and the details of construction well illustrated. . . . The work should be specially valuable to civil engineers engaged in work in Japan, but the interest is by no means confined to that locality."—*Engineer*.

"We congratulate the author upon the practical commonsense shown in the preparation of this work. . . . The plates and diagrams have evidently been prepared with great care, and cannot fail to be of great assistance to the student."—*Builder*.

"The whole art of water-works construction is dealt with in a clear and comprehensive fashion in this handsome volume. . . . Mr. Burton's practical treatise shows in all its sections the fruit of independent study and individual experience. It is largely based upon his own practice in the branch of engineering of which it treats."—*Saturday Review*.

THE WATER SUPPLY OF CITIES AND TOWNS.

By WILLIAM HUMBER, A. M. Inst. C.E., and M. Inst. M.E., Author of "Cast and Wrought Iron Bridge Construction," &c., &c. Illustrated with 50 Double Plates, 1 Single Plate, Coloured Frontispiece, and upwards of 250 Woodcuts, and containing 400 pp. of Text. Imp. 4to, elegantly and substantially half-bound in morocco *Net 26 6s.*

LIST OF CONTENTS.

I. HISTORICAL SKETCH OF SOME OF THE MEANS THAT HAVE BEEN ADOPTED FOR THE SUPPLY OF WATER TO CITIES AND TOWNS.—II. WATER AND THE FOREIGN MATTER USUALLY ASSOCIATED WITH IT.—III. RAINFALL AND EVAPORATION.—IV. SPRINGS AND THE WATER-BEARING FORMATIONS OF VARIOUS DISTRICTS.—V. MEASUREMENT AND ESTIMATION OF THE FLOW OF WATER.—VI. ON THE SELECTION OF THE SOURCE OF SUPPLY.—VII. WELLS.—VIII. RESERVOIRS.—IX. THE PURIFICATION OF WATER.—X. PUMPS.—XI. PUMPING MACHINERY.—XII. CONDUITS.—XIII. DISTRIBUTION OF WATER.—XIV. METERS, SERVICE PIPES, AND HOUSE FITTINGS.—XV. THE LAW OF ECONOMY OF WATER-WORKS.—XVI. CONSTANT AND INTERMITTENT SUPPLY.—XVII. DESCRIPTION OF PLATES.—APPENDICES, GIVING TABLES OF RATES OF SUPPLY, VELOCITIES, &c., &c., TOGETHER WITH SPECIFICATIONS OF SEVERAL WORKS ILLUSTRATED, AMONG WHICH WILL BE FOUND: ABERDEEN, BIDEFORD, CANTERBURY, DUNDEE, HALIFAX, LAMBETH, ROTHERHAM, DUBLIN, AND OTHERS.

"The most systematic and valuable work upon water supply hitherto produced in English, or in any other language. It is characterised almost throughout by an exhaustiveness much more distinctive of French and German than of English technical treatises."—*Engineer.*

RURAL WATER SUPPLY.

A Practical Handbook on the Supply of Water and Construction of Water-works for small Country Districts. By ALLAN GREENWELL, A.M.I.C.E., and W. T. CURRY, A.M.I.C.E., F.G.S. With Illustrations. Second Edition, Revised. Crown 8vo, cloth. *[Just Published. 5/0]*

"We conscientiously recommend it as a very useful book for those concerned in obtaining water for small districts, giving a great deal of practical information in a small compass."—*Builder.*

"The volume contains valuable information upon all matters connected with water supply. . . Full of details on points which are continually before water-works engineers."—*Nature.*

HYDRAULIC POWER ENGINEERING.

A Practical Manual on the Concentration and Transmission of Power by Hydraulic Machinery. By G. CROYDON MARKS, A.M. Inst. C.E. With nearly 200 Illustrations. 8vo, cloth. *[Just Published. Net 9/0]*

SUMMARY OF CONTENTS:—PRINCIPLES OF HYDRAULICS.—THE OBSERVED FLOW OF WATER.—HYDRAULIC PRESSURES, MATERIAL.—TEST LOAD PACKINGS FOR SLIDING SURFACES.—PIPE JOINTS.—CONTROLLING VALVES.—PLATFORM LIFTS.—WORKSHOP, FACTORY, AND DOCK CRANES.—HYDRAULIC ACCUMULATORS.—PRESSES.—SHEET METAL WORKING AND FORGING MACHINERY.—HYDRAULIC RIVETTERS.—HAND, POWER, AND STREAM PUMPS.—TURBINES.—IMPULSE AND RE-ACTION TURBINES.—DESIGN OF TURBINES.—WATER WHEELS.—HYDRAULIC ENGINES.—RECENT ACHIEVEMENTS.—TABLES.

"We have nothing but praise for this thoroughly valuable work. The author has succeeded in rendering his subject interesting as well as instructive."—*Practical Engineer.*

"Can be unhesitatingly recommended as a useful and up-to-date manual on hydraulic transmission and utilisation of power."—*Mechanical World.*

HYDRAULIC TABLES, CO-EFFICIENTS, & FORMULÆ.

For Finding the Discharge of Water from Orifices, Notches, Weirs, Pipes, and Rivers. With New Formulæ, Tables, and General Information on Rain-fall, Catchment-Basins, Drainage, Sewerage, Water Supply for Towns and Mill Power. By JOHN NEVILLE, Civil Engineer, M.R.I.A. Third Edition, revised, with additions. Numerous Illustrations. Crown 8vo, cloth . *14/0*

"It is, of all English books on the subject, the one nearest to completeness."—*Architect.*

HYDRAULIC MANUAL.

Consisting of Working Tables and Explanatory Text. Intended as a Guide in Hydraulic Calculations and Field Operations. By LEWIS D'A. JACKSON, Author of "Aid to Survey Practice," "Modern Metrology," &c. Fourth Edition, Enlarged. Large crown 8vo, cloth *16/0*

"The author has constructed a manual which may be accepted as a trustworthy guide to this branch of the engineer's profession."—*Engineering.*

WATER ENGINEERING.

A Practical Treatise on the Measurement, Storage, Conveyance, and Utilisation of Water for the Supply of Towns, for Mill Power, and for other Purposes. By C. SLAGG, A. M. Inst. C.E. Second Edition. Crown 8vo, cloth . *7/6*

"As a small practical treatise on the water supply of towns, and on some applications of water-power, the work is in many respects excellent."—*Engineering.*

THE RECLAMATION OF LAND FROM TIDAL WATERS.

A Handbook for Engineers, Landed Proprietors, and others interested in Works of Reclamation. By ALEXANDER BRAZELBY, M.Inst. C.E. With Illustrations. 8vo, cloth. *Just Published. Net 10/6*

"The book shows in a concise way what has to be done in reclaiming land from the sea, and the best way of doing it. The work contains a great deal of practical and useful information which cannot fail to be of service to engineers entrusted with the enclosure of salt marshes, and to landowners intending to reclaim land from the sea."—*The Engineer*.

"The author has carried out his task efficiently and well, and his book contains a large amount of information of great service to engineers and others interested in works of reclamation."—*Nature*.

MASONRY DAMS FROM INCEPTION TO COMPLETION.

Including numerous Formulae, Forms of Specification and Tender, Pocket Diagram of Forces, &c. For the use of Civil and Mining Engineers. By C. F. COURTNEY, M. Inst. C.E. 8vo, cloth. *Just Published. 9/0*

"The volume contains a good deal of valuable data, and furnishes the engineer with practical advice. Many useful suggestions will be found in the remarks on site and position, location of dam, foundations and construction."—*Building News*.

RIVER BARS.

The Causes of their Formation, and their Treatment by "Induced Tidal Scour"; with a Description of the Successful Reduction by this Method of the Bar at Dublin. By I. J. MANN, Assist. Eng. to the Dublin Port and Docks Board. Royal 8vo, cloth. *7/6*

"We recommend all interested in harbour works—and, indeed, those concerned in the improvements of rivers generally—to read Mr. Mann's interesting work."—*Engineer*.

TRAMWAYS: THEIR CONSTRUCTION AND WORKING.

Embracing a Comprehensive History of the System; with an exhaustive Analysis of the Various Modes of Traction, including Horse Power, Steam, Cable Traction, Electric Traction, &c.; a Description of the Varieties of Rolling Stock; and ample Details of Cost and Working Expenses. New Edition, Thoroughly Revised, and including the Progress recently made in Tramway Construction, &c., &c. By D. KINNEAR CLARK, M. Inst. C.E. With 400 Illustrations. 8vo, 780 pp., buckram. *Just Published. 28/0*

"The new volume is one which will rank, among tramway engineers and those interested in tramway working, with the Author's world-famed book on railway machinery."—*The Engineer*.

SURVEYING AS PRACTISED BY CIVIL ENGINEERS AND SURVEYORS.

Including the Setting-out of Works for Construction and Surveys Abroad, with many Examples taken from Actual Practice. A Handbook for use in the Field and the Office, intended also as a Text-book for Students. By JOHN WHITE-LAW, Jun., A.M. Inst. C.E., Author of "Points and Crossings." With about 260 Illustrations. Demy 8vo, cloth. *Just Published. Net 10/6*

PRACTICAL SURVEYING.

A Text-Book for Students preparing for Examinations or for Survey-work in the Colonies. By GEORGE W. USILL, A.M.I.C.E. With 4 Plates and upwards of 330 Illustrations. Seventh Edition. Including Tables of Natural Sines, Tangents, Secants, &c. Crown 8vo, cloth *7/6*; or, on THIN PAPER, leather, gilt edges, for pocket use. *12/6*

"The best forms of instruments are described as to their construction, uses and modes of employment, and there are innumerable hints on work and equipment such as the author, in his experience as surveyor, draughtsman and teacher, has found necessary, and which the student in his inexperience will find most serviceable."—*Engineer*.

"The latest treatise in the English language on surveying, and we have no hesitation in saying that the student will find it a better guide than any of its predecessors. Deserves to be recognised as the first book which should be put in the hands of a pupil of Civil Engineering."—*Architect*.

AID TO SURVEY PRACTICE.

For Reference in Surveying, Levelling, and Setting-out; and in Route Surveys of Travellers by Land and Sea. With Tables, Illustrations, and Records. By LEWIS D'A. JACKSON, A.M.I.C.E. 8vo, cloth. *12/6*

"A valuable *vade-mecum* for the surveyor. We recommend this book as containing an admirable supplement to the teaching of the accomplished surveyor."—*Athenæum*.

"The author brings to his work a fortunate union of theory and practical experience which, aided by a clear and lucid style of writing, renders the book a very useful one."—*Builder*.

SURVEYING WITH THE TACHEOMETER.

A practical Manual for the use of Civil and Military Engineers and Surveyors. Including two series of Tables specially computed for the Reduction of Readings in Sexagesimal and in Centesimal Degrees. By NEIL KENNEDY, M. Inst. C.E. With Diagrams and Plates. Demy 8vo, cloth. *Net 10/6*

"The work is very clearly written, and should remove all difficulties in the way of any surveyor desirous of making use of this useful and rapid instrument."—*Nature*.

ENGINEER'S & MINING SURVEYOR'S FIELD BOOK.

Consisting of a Series of Tables, with Rules, Explanations of Systems, and use of Theodolite for Traverse Surveying and plotting the work with minute accuracy by means of Straight Edge and Set Square only; Levelling with the Theodolite, Setting-out Curves with and without the Theodolite, Earthwork Tables, &c. By W. DAVIS HASKOLL, C.E. With numerous Woodcuts. Fourth Edition, Enlarged. Crown 8vo, cloth *12/0*

"The book is very handy; the separate tables of sines and tangents to every minute will make it useful for many other purposes, the genuine traverse tables existing all the same."—*Athenæum*.

LAND AND MARINE SURVEYING.

In Reference to the Preparation of Plans for Roads and Railways; Canals, Rivers, Towns' Water Supplies; Docks and Harbours. With Description and Use of Surveying Instruments. By W. DAVIS HASKOLL, C.E. Second Edition, Revised, with Additions. Large crown 8vo, cloth *9/0*

"This book must prove of great value to the student. We have no hesitation in recommending it, feeling assured that it will more than repay a careful study."—*Mechanical World*.

"A most useful book for the student. We strongly recommend it as a carefully-written and valuable text-book. It enjoys a well-deserved repute among surveyors."—*Builder*.

PRINCIPLES AND PRACTICE OF LEVELLING.

Showing its Application to Purposes of Railway and Civil Engineering in the Construction of Roads; with Mr. TELFORD'S Rules for the same. By FREDERICK W. SIMMS, F.G.S., M. Inst. C.E. Eighth Edition, with the addition of LAW'S Practical Examples for Setting-out Railway Curves, and TRAUTWINE'S Field Practice of Laying-out Circular Curves. With 7 Plates and numerous Woodcuts, 8vo, cloth *8/6*

^{} TRAUTWINE ON CURVES may be had separate *5/0*

"The text-book on levelling in most of our engineering schools and colleges."—*Engineer*.

"The publishers have rendered a substantial service to the profession, especially to the younger members, by bringing out the present edition of Mr. Simms's useful work."—*Engineering*.

AN OUTLINE OF THE METHOD OF CONDUCTING A TRIGONOMETRICAL SURVEY.

For the Formation of Geographical and Topographical Maps and Plans, Military Reconnaissance, LEVELLING, &c., with Useful Problems, Formulae, and Tables. By Lieut.-General FROME, R.E. Fourth Edition, Revised and partly Re-written by Major-General Sir CHARLES WARREN, G.C.M.G., R.E. With 19 Plates and 115 Woodcuts, royal 8vo, cloth *16/0*

"No words of praise from us can strengthen the position so well and so steadily maintained by this work. Sir Charles Warren has revised the entire work, and made such additions as were necessary to bring every portion of the contents up to the present date."—*Broad Arrow*.

TABLES OF TANGENTIAL ANGLES AND MULTIPLES FOR SETTING-OUT CURVES.

From 5 to 200 Radius. By A. BEAZELEY, M. Inst. C.E. 6th Edition, Revised. With an Appendix on the use of the Tables for Measuring up Curves: Printed on 50 Cards, and sold in a cloth box, waistcoat-pocket size. *[Just Published. 3/6]*

"Each table is printed on a card, which, placed on the theodolite, leaves the hands free to manipulate the instrument—no small advantage as regards the rapidity of work."—*Engineer*.

"Very handy: a man may know that all his day's work must fall on two of these cards, which he puts into his own card-case, and leaves the rest behind."—*Athenæum*.

HANDY GENERAL EARTH-WORK TABLES.

Giving the Contents in Cubic Yards of Centre and Slopes of Cuttings and Embankments from 3 inches to 80 feet in Depth or Height, for use with either 66 feet Chain or 100 feet Chain. By J. H. WATSON BUCK, M. Inst. C.E. On a Sheet mounted in cloth case. *[Just Published. 3/6]*

EARTHWORK TABLES.

Showing the Contents in Cubic Yards of Embankments, Cuttings, &c., of Heights or Depths up to an average of 80 feet. By JOSEPH BROADBENT, C.E., and FRANCIS CAMPIN, C.E. Crown 8vo, cloth 5/0

"The way in which accuracy is attained, by a simple division of each cross section into three elements, two in which are constant and one variable, is ingenious."—*Athenæum*.

A MANUAL ON EARTHWORK.

By ALEX. J. S. GRAHAM, C.E. With numerous Diagrams. Second Edition. 18mo, cloth 2/6

THE CONSTRUCTION OF LARGE TUNNEL SHAFTS.

A Practical and Theoretical Essay. By J. H. WATSON BUCK, M. Inst. C.E., Resident Engineer, L. and N. W. R. With Folding Plates, 8vo, cloth 12/0

"Many of the methods given are of extreme practical value to the mason, and the observations on the form of arch, the rules for ordering the stone, and the construction of the templates, will be found of considerable use. We commend the book to the engineering profession."—*Building News*.

"Will be regarded by civil engineers as of the utmost value, and calculated to save much time and obviate many mistakes."—*Colliery Guardian*.

CAST & WROUGHT IRON BRIDGE CONSTRUCTION

(A Complete and Practical Treatise on), including Iron Foundations. In Three Parts.—Theoretical, Practical, and Descriptive. By WILLIAM HUMBER, A. M. Inst. C.E., and M. Inst. M.E. Third Edition, revised and much improved, with 115 Double Plates (so of which now first appear in this edition), and numerous Additions to the Text. In 3 vols., imp. 4to, half-bound in morocco £6 16s. 6d.

"A very valuable contribution to the standard literature of civil engineering. In addition to elevations, plans, and sections, large scale details are given, which very much enhance the instructive worth of those illustrations."—*Civil Engineer and Architect's Journal*.

"Mr. Humber's stately volumes, lately issued—in which the most important bridges erected during the last five years, under the direction of the late Mr. Brunel, Sir W. Cubitt, Mr. Hawkshaw, Mr. Pags, Mr. Fowler, Mr. Hemans, and others among our most eminent engineers, are drawn and specified in great detail."—*Engineer*.

ESSAY ON OBLIQUE BRIDGES

(Practical and Theoretical). With 13 large Plates. By the late GEORGE WATSON BUCK, M.I.C.E. Fourth Edition, revised by his Son, J. H. WATSON BUCK, M.I.C.E.; and with the addition of Description to Diagrams for Facilitating the Construction of Oblique Bridges, by W. H. BARLOW, M.I.C.E. Royal 8vo, cloth 12/0

"The standard text-book for all engineers regarding skew arches is Mr. Buck's treatise, and it would be impossible to consult a better."—*Engineer*.

"Mr. Buck's treatise is recognised as a standard text-book, and his treatment has divested the subject of many of the intricacies supposed to belong to it. As a guide to the engineer and architect, on a confessedly difficult subject, Mr. Buck's work is unsurpassed."—*Building News*.

THE CONSTRUCTION OF OBLIQUE ARCHES

(A Practical Treatise on). By JOHN HART. Third Edition, with Plates. Imperial 8vo, cloth 8/0

GRAPHIC AND ANALYTIC STATICS.

In their Practical Application to the Treatment of Stresses in Roofs, Solid Girders, Lattice, Bowstring, and Suspension Bridges, Braced Iron Arches and Piers, and other Frameworks. By R. HUDSON GRAHAM, C.E. Containing Diagrams and Plates to Scale. With numerous Examples, many taken from existing Structures. Specially arranged for Class-work in Colleges and Universities. Second Edition, Revised and Enlarged. 8vo, cloth . . . 16/0

"Mr. Graham's book will find a place wherever graphic and analytic statics are used or studied."—*Engineer*.

"The work is excellent from a practical point of view, and has evidently been prepared with much care. The directions for working are simple, and are illustrated by an abundance of well-selected examples. It is an excellent text-book for the practical draughtsman."—*Athenæum*.

WEIGHTS OF WROUGHT IRON & STEEL GIRDERS.

A Graphic Table for Facilitating the Computation of the Weights of Wrought Iron and Steel Girders, &c., for Parliamentary and other Estimates. By J. H. WATSON BUCK, M. Inst. C.E. On a Sheet 2/6

PRACTICAL GEOMETRY.

For the Architect, Engineer, and Mechanic. Giving Rules or the Delineation and Application of various Geometrical Lines, Figures, and Curves. By E. W. TARN, M.A., Architect. 8vo, cloth 9/0

"No book with the same objects in view has ever been published in which the clearness of the rules laid down and the illustrative diagrams have been so satisfactory."—*Scotsman*.

THE GEOMETRY OF COMPASSES.

Or, Problems Resolved by the mere Description of Circles and the Use of Coloured Diagrams and Symbols. By OLIVER BYRNE. Coloured Plates. Crown 8vo, cloth 3/6

HANDY BOOK FOR THE CALCULATION OF STRAINS

In Girders and Similar Structures and their Strength. Consisting of Formulæ and Corresponding Diagrams, with numerous details for Practical Application, &c. By WILLIAM HUMBER, A. M. Inst. C.E., &c. Fifth Edition. Crown 8vo, with nearly 200 Woodcuts and 3 Plates, cloth 7/6

"The formulæ are neatly expressed, and the diagrams good."—*Athenæum*.

"We heartily commend this really *handy* book to our engineer and architect readers."—*English Mechanic*.

TRUSSES OF WOOD AND IRON.

Practical Applications of Science in Determining the Stresses, Breaking Weights, Safe Loads, Scantlings, and Details of Construction. With Complete Working Drawings. By WILLIAM GRIFFITHS, Surveyor. 8vo, cloth. 4/6

"This handy little book enters so minutely into every detail connected with the construction of roof trusses that no student need be ignorant of these matters."—*Practical Engineer*.

THE STRAINS ON STRUCTURES OF IRONWORK.

With Practical Remarks on Iron Construction. By F. W. SHEILDS, M.I.C.E. 8vo, cloth 5/0

A TREATISE ON THE STRENGTH OF MATERIALS.

With Rules for Application in Architecture, the Construction of Suspension Bridges, Railways, &c. By PETER BARLOW, F.R.S. A new Edition, revised by his Sons, P. W. BARLOW, F.R.S., and W. H. BARLOW, F.R.S.; to which are added, Experiments by HODGKINSON, FAIRBAIRN, and KIRKALDY; and Formulæ for calculating Girders, &c. Arranged and Edited by WM. HUMBER, A. M. Inst. C.E. 8vo, cloth 18/0

"Valuable alike to the student tyro, and the experienced practitioner, it will always rank in future as it has hitherto done, as the standard treatise on that particular subject."—*Engineer*.

"As a scientific work of the first class, it deserves a foremost place on the bookshelves of every civil engineer and practical mechanic."—*English Mechanic*.

SAFE RAILWAY WORKING.

A Treatise on Railway Accidents, their Cause and Prevention; with a Description of Modern Appliances and Systems. By CLEMENT E. STRETTON, C.E., Vice-President and Consulting Engineer, Amalgamated Society of Railway Servants. With Illustrations and Coloured Plates. Third Edition, Enlarged. Crown 8vo, cloth 3/6

"A book for the engineer, the directors, the managers; and, in short, all who wish for information on railway matters will find a perfect encyclopædia in 'Safe Railway Working.'"—*Railway Review*.

"We commend the remarks on railway signalling to all railway managers, especially where a uniform code and practice is advocated."—*Herepath's Railway Journal*.

EXPANSION OF STRUCTURES BY HEAT.

By JOHN KEILY, C.E., late of the Indian Public Works Department. Crown 8vo, cloth 3/6

"The aim the author has set before him, viz., to show the effects of heat upon metallic and other structures, is a laudable one, for this is a branch of physics upon which the engineer or architect can find but little reliable and comprehensive data in books."—*Builder*.

THE PROGRESS OF MODERN ENGINEERING.

Complete in Four Volumes, imperial 4to, half-morocco, price **£12 12s.**

Each volume sold separately, as follows:—

FIRST SERIES, Comprising Civil, Mechanical, Marine, Hydraulic, Railway, Bridge, and other Engineering Works, &c. By **WILLIAM HUMBER, A. M. Inst. C.E., &c.** Imp. 4to, with 36 Double Plates, drawn to a large scale, Photographic Portrait of John Hawkshaw, C.E., F.R.S., &c., and copious descriptive Letterpress, Specifications, &c. Half-morocco . . . **£3 3s.**

LIST OF THE PLATES AND DIAGRAMS.

VICTORIA STATION AND ROOF, L. B. & S. C. R. (8 PLATES); SOUTHPORT PIER (2 PLATES); VICTORIA STATION AND ROOF, L. C. & D. AND G. W. R. (6 PLATES); ROOF OF CREMORNE MUSIC HALL; BRIDGE OVER G. N. RAILWAY; ROOF OF STATION, DUTCH RHENISH RAIL. (2 PLATES); BRIDGE OVER THE THAMES, WEST LONDON EXTENSION RAILWAY (5 PLATES); ARMOUR PLATES; SUSPENSION BRIDGE, THAMES (4 PLATES); THE ALLEN ENGINE; SUSPENSION BRIDGE, AVON (5 PLATES); UNDERGROUND RAILWAY (5 PLATES).

HUMBER'S MODERN ENGINEERING.

SECOND SERIES. Imp. 4to, with 3 Double Plates, Photographic Portrait of Robert Stephenson, C.E., M.P., F.R.S., &c., and copious descriptive Letterpress, Specifications, &c. Half-morocco . . . **£3 3s.**

LIST OF THE PLATES AND DIAGRAMS.

BIRKENHEAD DOCKS, LOW WATER BASIN (15 PLATES); CHARING CROSS STATION ROOF, C. C. RAILWAY (5 PLATES); DIGSWELL VIADUCT, GREAT NORTHERN RAILWAY; ROBBERY WOOD VIADUCT, GREAT NORTHERN RAILWAY; IRON PERMANENT WAY; CLYDACH VIADUCT, MERTHYR, TREDEGAR, AND ABERGAVENNY RAILWAY; EBBW VIADUCT, MERTHYR, TREDEGAR, AND ABERGAVENNY RAILWAY; COLLEGE WOOD VIADUCT, CORNWALL RAILWAY; DUBLIN WINTER PALACE ROOF (3 PLATES); BRIDGE OVER THE THAMES, L. C. & D. RAILWAY (6 PLATES); ALBERT HARBOUR, GREENOCK (4 PLATES).

HUMBER'S MODERN ENGINEERING.

THIRD SERIES. Imp. 4to, with 40 Double Plates, Photographic Portrait of J. R. M'Clean, late Pres. Inst. C.E., and copious descriptive Letterpress, Specifications, &c. Half-morocco . . . **£3 3s.**

LIST OF THE PLATES AND DIAGRAMS.

MAIN DRAINAGE, METROPOLIS.—North Side.—MAP SHOWING INTERCEPTION OF SEWERS; MIDDLE LEVEL SEWER (2 PLATES); OUTFALL SEWER, BRIDGE OVER RIVER LEA (3 PLATES); OUTFALL SEWER, BRIDGE OVER MARSH LANE, NORTH WOOLWICH RAILWAY, AND BOW AND BARKING RAILWAY JUNCTION; OUTFALL SEWER, BRIDGE OVER BOW AND BARKING RAILWAY (3 PLATES); OUTFALL SEWER, BRIDGE OVER EAST LONDON WATER-WORKS' FEEDER (2 PLATES); OUTFALL SEWER RESERVOIR (2 PLATES); OUTFALL SEWER, TUMBLING BAY AND OUTLET; OUTFALL SEWER, FENSTOCKS. South Side.—OUTFALL SEWER, BERMONDSEY BRANCH (2 PLATES); OUTFALL SEWER, RESERVOIR AND OUTLET (2 PLATES); OUTFALL SEWER, FILTH HOIST; SECTIONS OF SEWERS NORTH AND SOUTH SIDES).

THAMES EMBANKMENT.—SECTION OF RIVER WALL; STEAMBOAT PIER, WESTMINSTER (2 PLATES); LANDING STAIRS BETWEEN CHARING CROSS AND WATERLOO BRIDGES; YORK GATE (2 PLATES); OVERFLOW AND OUTLET AT SAVOY STREET SEWER (3 PLATES); STEAMBOAT PIER, WATERLOO BRIDGE (3 PLATES); JUNCTION OF SEWERS, PLANS AND SECTIONS; GULLIES, PLANS AND SECTIONS; ROLLING STOCK; GRANITE AND IRON FORTS.

HUMBER'S MODERN ENGINEERING.

FOURTH SERIES. Imp. 4to, with 36 Double Plates, Photographic Portrait of John Fowler, late Pres. Inst. C.E., and copious descriptive Letterpress, Specifications, &c. Half-morocco . . . **£3 3s.**

LIST OF THE PLATES AND DIAGRAMS.

ABBEY MILLS PUMPING STATION, MAIN DRAINAGE, METROPOLIS (4 PLATES); BARROW DOCKS (5 PLATES); MARQUIS VIADUCT, SANTIAGO AND VALPARAISO RAILWAY, (2 PLATES); ADAM'S LOCOMOTIVE, ST. HELENS' CANAL RAILWAY (2 PLATES); CANNON STREET STATION ROOF, CHARING CROSS RAILWAY (5 PLATES); ROAD BRIDGE OVER THE RIVER MOKA (2 PLATES); TELEGRAPHIC APPARATUS FOR MESOPOTAMIA; VIADUCT OVER THE RIVER WYE, MIDLAND RAILWAY (3 PLATES); ST. GERMAN'S VIADUCT, CORNWALL RAILWAY (2 PLATES); WROUGHT-IRON CYLINDER FOR DIVING BELL, MILLWALL DOCKS (6 PLATES); MILROY'S PATENT EXCAVATOR; METROPOLITAN DISTRICT RAILWAY (6 PLATES); HARBOURS, PORTS, AND BREAKWATERS (5 PLATES).

MARINE ENGINEERING, SHIPBUILDING, NAVIGATION, &c.

THE NAVAL ARCHITECT'S AND SHIPBUILDER'S POCKET-BOOK of Formulæ, Rules, and Tables, and Marine Engineer's and Surveyor's Handy Book of Reference. By CLEMENT MACKROW, M.I.N.A. Eighth Edition, Carefully Revised and Enlarged. Fcap., leather.

[Just Published. Net 12/6

SUMMARY OF CONTENTS:—SIGNS AND SYMBOLS, DECIMAL FRACTIONS.—TRIGONOMETRY.—PRACTICAL GEOMETRY.—MENSURATION.—CENTRES AND MOMENTS OF FIGURES.—MOMENTS OF INERTIA AND RADII OF GYRATION.—ALGEBRAICAL EXPRESSIONS FOR SIMPSON'S RULES.—MECHANICAL PRINCIPLES.—CENTRE OF GRAVITY.—LAWS OF MOTION.—DISPLACEMENT, CENTRE OF BUOYANCY.—CENTRE OF GRAVITY OF SHIP'S HULL.—STABILITY CURVES AND METACENTRES.—SEA AND SHALLOW-WATER WAVES.—ROLLING OF SHIPS.—PROPULSION AND RESISTANCE OF VESSELS.—SPEED TRIALS.—SAILING CENTRE OF EFFORT.—DISTANCES DOWN RIVERS, COAST LINES.—STEERING AND RUDERS OF VESSELS.—LAUNCHING CALCULATIONS AND VELOCITIES.—WEIGHT OF MATERIAL AND GEAR.—GUN PARTICULARS AND WEIGHT.—STANDARD GAUGES.—RIVETED JOINTS AND RIVETING.—STRENGTH AND TESTS OF MATERIALS.—BINDING AND SHEARING STRESSES, &c.—STRENGTH OF SHAFTING, PILLARS, WHEELS, &c.—HYDRAULIC DATA, &c.—CONIC SECTIONS, CATENARIAN CURVES.—MECHANICAL POWERS, WORK.—BOARD OF TRADE REGULATIONS FOR BOILERS AND ENGINES.—BOARD OF TRADE REGULATIONS FOR SHIPS.—LLOYD'S RULES FOR BOILERS.—LLOYD'S WEIGHT OF CHAINS.—LLOYD'S SCANTLINGS FOR SHIPS.—DATA OF ENGINES AND VESSELS.—SHIPS' FITTINGS AND TESTS.—SEASONING PRESERVING TIMBER.—MEASUREMENT OF TIMBER.—ALLOYS, PAINTS, VARNISHES.—DATA FOR STOWAGE.—ADMIRALTY TRANSPORT REGULATIONS.—RULES FOR HORSE-POWER, SCREW PROPELLERS, &c.—PERCENTAGES FOR BUTT STRAPS, &c.—PARTICULARS OF YACHTS.—MASTING AND RIGGING VESSELS.—DISTANCES OF FOREIGN PORTS.—TONNAGE TABLES.—VOCABULARY OF FRENCH AND ENGLISH TERMS.—ENGLISH WEIGHTS AND MEASURES.—FOREIGN WEIGHTS AND MEASURES.—DECIMAL EQUIVALENTS.—FOREIGN MONEY.—DISCOUNT AND WAGES TABLES.—USEFUL NUMBERS AND READY RECKONERS.—TABLES OF CIRCULAR MEASURES.—TABLES OF AREAS OF AND CIRCUMFERENCES OF CIRCLES.—TABLES OF AREAS OF SEGMENTS OF CIRCLES.—TABLES OF SQUARES AND CUBES AND ROOTS OF NUMBERS.—TABLES OF LOGARITHMS OF NUMBERS.—TABLES OF HYPERBOLIC LOGARITHMS.—TABLES OF NATURAL SINES, TANGENTS, &c.—TABLES OF LOGARITHMIC SINES, TANGENTS, &c.

"In these days of advanced knowledge a work like this is of the greatest value. It contains a vast amount of information. We unhesitatingly say that it is the most valuable compilation for its specific purpose that has ever been printed. No naval architect, engineer, surveyor, or seaman, wood or iron shipbuilder, can afford to be without this work."—*Nautical Magazine*.

"Should be used by all who are engaged in the construction or design of vessels. . . . Will be found to contain the most useful tables and formulæ required by shipbuilders, carefully collected from the best authorities, and put together in a popular and simple form. The book is one of exceptional merit."—*Engineer*.

"The professional shipbuilder has now, in a convenient and accessible form, reliable data for solving many of the numerous problems that present themselves in the course of his work."—*Iron*.

"There is no doubt that a pocket-book of this description must be a necessity in the ship-building trade. . . . The volume contains a mass of useful information clearly expressed and presented in a handy form."—*Marine Engineer*.

WANNAN'S MARINE ENGINEER'S GUIDE

To Board of Trade Examinations for Certificates of Competency. Containing all Latest Questions to Date, with Simple, Clear, and Correct Solutions; 302 Elementary Questions with Illustrated Answers, and Verbal Questions and Answers; complete Set of Drawings with Statements completed. By A. C. WANNAN, C.E., Consulting Engineer, and E. W. I. WANNAN, M.I.M.E., Certificated First Class Marine Engineer. Illustrated with numerous Engravings. Third Edition, Revised and Enlarged. 500 pages. Large crown 8vo, cloth.

[Just Published. Net 10/6

"The book is clearly and plainly written and avoids unnecessary explanations and formulæ, and we consider it a valuable book for students of marine engineering."—*Nautical Magazine*.

WANNAN'S MARINE ENGINEER'S POCKET-BOOK

Containing the Latest Board of Trade Rules and Data for Marine Engineers. By A. C. WANNAN. Third Edition, Revised, Enlarged, and Brought Up to Date. Square 18mo, with thumb Index, leather. [Just Published. 5/0

"There is a great deal of useful information in this little pocket-book. It is of the rule-of-thumb order, and is, on that account, well adapted to the uses of the sea-going engineer."—*Engineer*.

SEA TERMS, PHRASES, AND WORDS

(Technical Dictionary of) used in the English and French Languages (English-French, French-English). For the Use of Seamen, Engineers, Pilots, Shipbuilders, Shipowners, and Ship-brokers. Compiled by W. PIRRIE, late of the African Steamship Company. Fcap. 8vo, cloth limp 5/0

"This volume will be highly appreciated by seamen, engineers, pilots, shipbuilders and ship-owners. It will be found wonderfully accurate and complete."—*Seafarer*.
 "A very useful dictionary, which has long been wanted by French and English engineers, masters, officers and others."—*Shipping World*.

ELECTRIC SHIP-LIGHTING.

A Handbook on the Practical Fitting and Running of Ships' Electrical Plant, for the Use of Shipowners and Builders, Marine Electricians and Sea-going Engineers in Charge. By J. W. URQUHART, Author of "Electric Light," "Dynamo Construction," &c. Second Edition, Revised and Extended. 326 pp., with 88 Illustrations. Crown 8vo, cloth. [Just Published. 7/6

MARINE ENGINEER'S POCKET-BOOK.

Consisting of useful Tables and Formulæ. By FRANK PROCTOR, A.I.N.A. Third Edition. Royal 32mo, leather, gilt edges, with strap 4/0

"We recommend it to our readers as going far to supply a long-felt want."—*Naval Science*.
 "A most useful companion to all marine engineers."—*United Service Gazette*.

ELEMENTARY ENGINEERING.

A Manual for Young Marine Engineers and Apprentices. In the Form of Questions and Answers on Metals, Alloys, Strength of Materials, Construction and Management of Marine Engines and Boilers, Geometry, &c., &c. With an Appendix of Useful Tables. By J. S. BREWER. Crown 8vo, cloth . . . 1/6

"Contains much valuable information for the class for whom it is intended, especially in the chapters on the management of boilers and engines."—*Nautical Magazine*.

MARINE ENGINES AND STEAM VESSELS.

A Treatise on. By ROBERT MURRAY, C.E. Eighth Edition, thoroughly Revised, with considerable Additions by the Author and by GEORGE CARLISLE, C.E., Senior Surveyor to the Board of Trade. 12mo, cloth . . . 4/6

PRACTICAL NAVIGATION.

Consisting of THE SAILOR'S SEA-BOOK, by JAMES GREENWOOD and W. H. ROSSER; together with the exquisite Mathematical and Nautical Tables for the Working of the Problems, by HENRY LAW, C.E., and Professor J. R. YOUNG. Illustrated. 12mo, strongly half-bound 7/0

THE ART AND SCIENCE OF SAILMAKING.

By SAMUEL B. SADLER, Practical Sailmaker, late in the employment of Messrs. Ratsey and Laphorne, of Cowes and Gosport. With Plates and other Illustrations. Small 4to, cloth 12/6

"This extremely practical work gives a complete education in all the branches of the manufacture, cutting out, roping, seaming, and goring. It is copiously illustrated, and will form a first-rate text-book and guide."—*Portsmouth Times*.

CHAIN CABLES AND CHAINS.

Comprising Sizes and Curves of Links, Studs, &c., Iron for Cables and Chains, Chain Cable and Chain Making, Forming and Welding Links, Strength of Cables and Chains, Certificates for Cables, Marking Cables, Prices of Chain Cables and Chains, Historical Notes, Acts of Parliament, Statutory Tests, Charges for Testing, List of Manufacturers of Cables, &c., &c. By THOMAS W. TRAILL, F.E.R.N., M.Inst.C.E., Engineer-Surveyor-in-Chief, Board of Trade, Inspector of Chain Cable and Anchor Proving Establishments, and General Superintendent Lloyd's Committee on Proving Establishments. With numerous Tables, Illustrations, and Lithographic Drawings. Folio, cloth, bevelled boards. £2 2s.

"It contains a vast amount of valuable information. Nothing seems to be wanting to make it a complete and standard work of reference on the subject."—*Nautical Magazine*.

MINING, METALLURGY, AND COLLIERY WORKING.

THE DEEP LEVEL MINES OF THE RAND,

And their Future Development, considered from the Commercial Point of View. By G. A. DENNY, M.N.E. Inst. M.E., Consulting Engineer to the General Mining and Finance Corporation, Ltd., of London, Berlin, Paris, and Johannesburg. Fully Illustrated with Diagrams and Folding Plates. Royal 8vo, buckram. [Just Published. Net 25/0

"Mr. Denny by confining himself to the consideration of the future of the deep-level mines of the Rand breaks new ground, and by dealing with the subject rather from a commercial standpoint than from a scientific one, appeals to a wide circle of readers. The book cannot fail to prove of very great value to investors in South African mines."—*Mining Journal*.

"The volume will interest all who are concerned in any way with the Witwatersrand Goldfields."—*The Times*.

PROSPECTING FOR GOLD.

A Handbook of Information and Hints for Prospectors based on Personal Experience. By DANIEL J. RANKIN, F.R.S.G.S., M.R.A.S. Author of "The Zambesi Basin," &c.; formerly Manager of the Central African Company, and Leader of African Gold Prospecting Expeditions. With Illustrations specially Drawn and Engraved for the Work. Fcap. 8vo, leather. Net 7/6

"This well-compiled book contains a collection of the richest gems of useful knowledge for the prospector's benefit. A special table is given to accelerate the spotting at a glance of minerals associated with gold."—*Mining Journal*.

THE METALLURGY OF GOLD.

A Practical Treatise on the Metallurgical Treatment of Gold-bearing Ores. Including the Assaying, Melting, and Refining of Gold. By M. EISSLER, A.I.M.E., M. Inst. M.M. Fifth Edition, Enlarged. With 300 Illustrations and Folding Plates. Medium 8vo, cloth. [Just Published. Net 21/0

"This book thoroughly deserves its title of a 'Practical Treatise.' The whole process of gold milling, from the breaking of the quartz to the assay of the bullion, is described in clear and orderly narrative and with much, but not too much, fullness of detail."—*Saturday Review*.

"The work is a storehouse of information and valuable data, and we strongly recommend it to all professional men engaged in the gold-mining industry."—*Mining Journal*.

THE CYANIDE PROCESS OF GOLD EXTRACTION.

Including its Practical Application on the Witwatersrand Gold Fields and elsewhere. By M. EISSLER, M.E. With Diagrams and Working Drawings. Third Edition, Revised and Enlarged. 8vo, cloth. Net 7/6

"This book is just what was needed to acquaint mining men with the actual working of a process which is not only the most popular, but is, as a general rule, the most successful for the extraction of gold from tailings."—*Mining Journal*.

DIAMOND DRILLING FOR GOLD & OTHER MINERALS.

A Practical Handbook on the Use of Modern Diamond Core Drills in Prospecting and Exploiting Mineral-Bearing Properties, including Particulars of the Costs of Apparatus and Working. By G. A. DENNY, M.N.E. Inst. M.E., M.I.M. and M. Medium 8vo, 168 pp., with Illustrative Diagrams. 12/6

"Mr. Denny deserves grateful recognition for supplying a decided want. We strongly recommend every board of directors to carefully peruse the pages of this valuable volume of eminently practical data, which should be in the possession of those interested in mining."—*Mining Journal*.

FIELD TESTING FOR GOLD AND SILVER.

A Practical Manual for Prospectors and Miners. By W. H. MERRITT, M.N.E. Inst. M.E., A.R.S.M., &c. Fcap. 8vo, leather. Net 5/0

"As an instructor of prospectors' classes Mr. Merritt has the advantage of knowing exactly the information likely to be most valuable to the miner in the field. The work will be a useful addition to a prospector's kit."—*Mining Journal*.

"It gives the gist of the author's experience as a teacher of prospectors, and is a book which no prospector could use habitually without finding it pan out well."—*Scotsman*.

THE PROSPECTOR'S HANDBOOK.

A Guide for the Prospector and Traveller in search of Metal-Bearing or other Valuable Minerals. By J. W. ANDERSON, M.A. (Camb.), F.R.G.S. Ninth Edition. Crown 8vo, cloth, 3/6; or, leather, pocket-book form. 4/6

"Will supply a much-felt want, especially among Colonists, in whose way are so often thrown many mineralogical specimens the value of which it is difficult to determine."—*Engineer*.

"How to find commercial minerals, and how to identify them when they are found, are the leading points to which attention is directed. The author has managed to pack as much practical detail into his pages as would supply material for a book three times its size."—*Mining Journal*.

THE METALLURGY OF SILVER.

A Practical Treatise on the Amalgamation, Roasting, and Lixiviation of Silver Ores. Including the Assaying, Melting, and Refining of Silver Bullion. By M. EISSLER, Author of "The Metallurgy of Gold," &c. Third Edition. Crown 8vo, cloth 10/6

"A practical treatise, and a technical work which we are convinced will supply a long-felt want amongst practical men, and at the same time be of value to students and others indirectly connected with the industries."—*Mining Journal*.

"From first to last the book is thoroughly sound and reliable."—*Colliery Guardian*.

"For chemists, practical miners, assayers, and investors alike we do not know of any work on the subject so handy and yet so comprehensive."—*Glasgow Herald*.

THE HYDRO-METALLURGY OF COPPER.

Being an Account of Processes Adopted in the Hydro-Metallurgical Treatment of Cupriferous Ores, Including the Manufacture of Copper Vitriol, with Chapters on the Sources of Supply of Copper and the Roasting of Copper Ores. By M. EISSLER, M.I.M.M. Medium 8vo, cloth. [Just Published. Net 12/6

THE METALLURGY OF ARGENTIFEROUS LEAD.

A Practical Treatise on the Smelting of Silver-Lead Ores and the Refining of Lead Bullion. Including Reports on various Smelting Establishments and Descriptions of Modern Smelting Furnaces and Plants in Europe and America. By M. EISSLER, M.E., Author of "The Metallurgy of Gold," &c. Crown 8vo, 400 pp., with 183 Illustrations, cloth 12/6

"The numerous metallurgical processes, which are fully and extensively treated of, embrace all the stages experienced in the passage of the lead from the various natural states to its issue from the refinery as an article of commerce."—*Practical Engineer*.

"The present volume fully maintains the reputation of the author. Those who wish to obtain a thorough insight into the present state of this industry cannot do better than read this volume, and all mining engineers cannot fail to find many useful hints and suggestions in it."—*Industries*.

METALLIFEROUS MINERALS AND MINING.

By D. C. DAVIES, F.G.S. Sixth Edition, thoroughly Revised and much Enlarged by his Son, E. HENRY DAVIES, M.E., F.G.S. 600 pp., with 273 Illustrations. Large crown 8vo, cloth [Just Published. Net 12/6

"Neither the practical miner nor the general reader, interested in mines, can have a better book for his companion and his guide."—*Mining Journal*.

"As a history of the present state of mining throughout the world this book has a real value, and it supplies an actual want."—*Athenæum*.

MACHINERY FOR METALLIFEROUS MINES.

A Practical Treatise for Mining Engineers, Metallurgists, and Managers of Mines. By E. HENRY DAVIES, M.E., F.G.S. Medium 8vo, cloth, 600 pp. With Folding Plates and other Illustrations. [Just Published. Net 25/0

"Mr. Davies, in this handsome volume, has done the advanced student and the manager of mines good service. Almost every kind of machinery in actual use is carefully described, and the woodcuts and plates are good."—*Athenæum*.

"From cover to cover the work exhibits all the same characteristics which excite the confidence and attract the attention of the student as he peruses the first page. The work may safely be recommended. By its publication the literature connected with the industry will be enriched and the reputation of its author enhanced."—*Mining Journal*.

EARTHY AND OTHER MINERALS AND MINING.

By D. C. DAVIES, F.G.S., Author of "Metalliferous Minerals," &c. Third Edition, Revised and Enlarged by his Son, E. HENRY DAVIES, M.E., F.G.S. With about 100 Illustrations. Crown 8vo, cloth 12/6

"We do not remember to have met with any English work on mining matters that contains the same amount of information packed in equally convenient form."—*Academy*.

"We should be inclined to rank it as among the very best of the handy technical and trades manuals which have recently appeared."—*British Quarterly Review*.

BRITISH MINING.

A Treatise on the History, Discovery, Practical Development, and Future Prospects of Metalliferous Mines in the United Kingdom. By ROBERT HUNT, F.R.S., late Keeper of Mining Records. Upwards of 950 pp., with 230 Illustrations. Second Edition, Revised. Super-royal 8vo, cloth 22 2s.

"The book is a treasure-house of statistical information on mining subjects, and we know of no other work embodying so great a mass of matter of this kind. Were this the only merit of Mr. Hunt's volume it would be sufficient to render it indispensable in the library of every one interested in the development of the mining and metallurgical industries of this country."—*Athenæum*.

POCKET-BOOK FOR MINERS AND METALLURGISTS.

Comprising Rules, Formulae, Tables, and Notes for Use in Field and Office Work. By F. DANVERS POWER, F.G.S., M.E. Second Edition, Corrected. Fcap. 8vo, leather. [Just Published. 9/0

"This excellent book is an admirable example of its kind, and ought to find a large sale amongst English-speaking prospectors and mining engineers."—*Engineering*.

THE MINER'S HANDBOOK.

A Handy Book of Reference on the subjects of Mineral Deposits, Mining Operations, Ore Dressing, &c. For the Use of Students and others interested in Mining Matters. By JOHN MILNE, F.R.S., Professor of Mining in the Imperial University of Japan. Third Edition. Fcap. 8vo, leather . 7/6

"Professor Milne's handbook is sure to be received with favour by all connected with mining, and will be extremely popular among students."—*Athenaeum*.

THE IRON ORES OF GREAT BRITAIN and IRELAND.

Their Mode of Occurrence, Age and Origin, and the Methods of Searching for and Working Them. With a Notice of some of the Iron Ores of Spain. By J. D. KENDALL, F.G.S., Mining Engineer. Crown 8vo, cloth . . 16/0

MINE DRAINAGE.

A Complete Practical Treatise on Direct-Acting Underground Steam Pumping Machinery. By STEPHEN MICHELL. Second Edition, Re-written and Enlarged, 390 pp. With 250 Illustrations. Royal 8vo, cloth. Net 25/0

SUMMARY OF CONTENTS:—HORIZONTAL PUMPING ENGINES.—ROTARY AND NON ROTARY HORIZONTAL ENGINES.—SIMPLE AND COMPOUND STEAM PUMPS.—VERTICAL PUMPING ENGINES.—ROTARY AND NON-ROTARY VERTICAL ENGINES.—SIMPLE AND COMPOUND STEAM PUMPS.—TRIPLE-EXPANSION STEAM PUMPS.—PULSATING STEAM PUMPS.—PUMP VALVES.—SINKING PUMPS, &c., &c.

"This volume contains an immense amount of important and interesting new matter. The book should undoubtedly prove of great use to all who wish for information on the subject, inasmuch as the different patterns of steam pumps are not alone lucidly described and clearly illustrated, but in addition numerous tables are supplied, in which their sizes, capacity, price, &c., are set forth, hence facilitating immensely the rational selection of a pump to suit any purpose that the reader may desire, or, on the other hand, supplying him with useful information about any of the pumps that come within the scope of the volume."—*The Engineer*.

ELECTRICITY AS APPLIED TO MINING.

A Practical Treatise for Mining Engineers. By ARNOLD LUPTON, M.Inst.C.E., M.I.E.E., G. D. ASPINALL PARR, M.I.E.E., and HERBERT PERKIN, M.I.M.E. With a large number of Illustrations. Medium 8vo, cloth.

[Just Published. Net 7/6

THE COLLIERY MANAGER'S HANDBOOK.

A Comprehensive Treatise on the Laying-out and Working of Collieries, Designed as a Book of Reference for Colliery Managers, and for the Use of Coal Mining Students preparing for First-class Certificates. By CALEB PAMELY, Mining Engineer and Surveyor; Member of the North of England Institute of Mining and Mechanical Engineers; and Member of the South Wales Institute of Mining Engineers. With 700 Plans, Diagrams, and other Illustrations. Fourth Edition, Revised and Enlarged, medium 8vo, over 900 pp. Strongly bound £1 5s.

SUMMARY OF CONTENTS:—GEOLOGY.—SEARCH FOR COAL.—MINERAL LEASES AND OTHER HOLDINGS.—SHAFT SINKING.—FITTING UP THE SHAFT AND SURFACE ARRANGEMENTS.—STEAM BOILERS AND THEIR FITTINGS.—TIMBERING AND WALLING.—NARROW WORK AND METHODS OF WORKING.—UNDERGROUND CONVEYANCE.—DRAINAGE.—THE GASES MET WITH IN MINES; VENTILATION.—ON THE FRICTION OF AIR IN MINES.—THE PRIESTMAN OIL ENGINE; PETROLEUM AND NATURAL GAS.—SURVEYING AND PLANNING.—SAFETY LAMPS AND FIRE-DAMP DETECTORS.—SUNDRY AND INCIDENTAL OPERATIONS AND APPLIANCES.—COLLIERY EXPLOSIONS.—MISCELLANEOUS QUESTIONS AND ANSWERS.—Appendix: SUMMARY OF REPORT OF H.M. COMMISSIONERS ON ACCIDENTS IN MINES.

"Mr. Pameley has not only given us a comprehensive reference book of a very high order, suitable to the requirements of mining engineers and colliery managers, but has also provided mining students with a class-book that is as interesting as it is instructive."—*Colliery Manager*.

"Mr. Pameley's work is eminently suited to the purpose for which it is intended, being clear, interesting, exhaustive, rich in detail, and up to date, giving descriptions of the latest machines in every department. A mining engineer could scarcely go wrong who followed this work."—*Colliery Guardian*.

"This is the most complete 'all-round work on coal-mining published in the English language. . . . No library of coal-mining books is complete without it."—*Colliery Engineer* Scranton, Pa., U.S.A.).

COLLIERY WORKING AND MANAGEMENT.

Comprising the Duties of a Colliery Manager, the Oversight and Arrangement of Labour and Wages, and the different Systems of Working Coal Seams. By H. F. BULMAN and R. A. S. REDMAYNE. 350 pp., with 88 Plates and other Illustrations, including Underground Photographs. Medium 8vo, cloth. [Just Published. 15/0

"This is, indeed, an admirable Handbook for Colliery Managers, in fact it is an indispensable adjunct to a Colliery Manager's education, as well as being a most useful and interesting work on the subject for all who in any way have to do with coal mining. The underground photographs are an attractive feature of the work, being very lifelike and necessarily true representations of the scenes they depict."—*Colliery Guardian*.

"Mr. Bulman and Mr. Redmayne, who are both experienced Colliery Managers of great literary ability, are to be congratulated on having supplied an authoritative work dealing with a side of the subject of coal mining which has hitherto received but scant treatment. The authors elucidate their text by 119 woodcuts and 88 plates, most of the latter being admirable reproductions of photographs taken underground with the aid of the magnesium flash-light. These illustrations are excellent."—*Nature*.

COAL AND COAL MINING.

By the late Sir WARINGTON W. SMYTH, F.R.S., Chief Inspector of the Mines of the Crown. Eighth Edition, Revised and Extended by T. FORSTER BROWN, Mining Engineer, Chief Inspector of the Mines of the Crown and of the Duchy of Cornwall. Crown 8vo, cloth. [Just Published. 3/6

"As an outline is given of every known coal-field in this and other countries, as well as of the principal methods of working, the book will doubtless interest a very large number of readers."—*Mining Journal*.

NOTES AND FORMULÆ FOR MINING STUDENTS.

By JOHN HERMAN MERIVALE, M.A., Late Professor of Mining in the Durham College of Science, Newcastle-upon-Tyne. Fourth Edition, Revised and Enlarged. By H. F. BULMAN, A.M.Inst.C.E. Small crown 8vo, cloth. 2/6

"The author has done his work in a creditable manner, and has produced a book that will be of service to students and those who are practically engaged in mining operations."—*Engineer*.

INFLAMMABLE GAS AND VAPOUR IN THE AIR

(The Detection and Measurement of). By FRANK CLOWES, D.Sc., Lond., F.I.C., Prof. of Chemistry in the University College, Nottingham. With a Chapter on THE DETECTION AND MEASUREMENT OF PETROLEUM VAPOUR by BOVERTON REDWOOD, F.R.S.E., Consulting Adviser to the Corporation of London under the Petroleum Acts. Crown 8vo, cloth. Net 5/0

"Professor Clowes has given us a volume on a subject of such industrial importance . . . Those interested in these matters may be recommended to study this book, which is easy of comprehension and contains many good things."—*The Engineer*.

"A book that no mining engineer—certainly no coal miner—can afford to ignore or to leave unread."—*Mining Journal*.

COAL & IRON INDUSTRIES of the UNITED KINGDOM.

Comprising a Description of the Coal Fields, and of the Principal Seams of Coal, with Returns of their Produce and its Distribution, and Analyses of Special Varieties. Also, an Account of the Occurrence of Iron Ores in Veins or Seams; Analyses of each Variety; and a History of the Rise and Progress of Pig Iron Manufacture. By RICHARD MEADE. 8vo, cloth. . . . 61 8s.

"Of this book we may unreservedly say that it is the best of its class which we have ever met. . . . A book of reference which no one engaged in the iron or coal trades should omit from his library."—*Iron and Coal Trades Review*.

ASBESTOS AND ASBESTIC.

Their Properties, Occurrence, and Use. By ROBERT H. JONES, F.S.A., Mineralogist, Hon. Mem. Asbestos Club, Black Lake, Canada. With Ten Collotype Plates and other Illustrations. Demy 8vo, cloth. [Just Published. 16/0

"An interesting and invaluable work."—*Colliery Guardian*.

GRANITES AND OUR GRANITE INDUSTRIES.

By GEORGE F. HARRIS, F.G.S., Membre de la Société Belge de Géologie, Lecturer on Economic Geology at the Birkbeck Institution, &c. With Illustrations. Crown 8vo, cloth. 2/6

"A clearly and well-written manual for persons engaged or interested in the granite industry."—*Scotsman*.

TRAVERSE TABLES.

For use in Mine Surveying. By W. LINTERN, Mining Engineer. Crown 8vo, cloth. [Just Published. Net 3/0

ELECTRICITY, ELECTRICAL ENGINEERING, &c.

SUBMARINE TELEGRAPHS.

Their History, Construction, and Working. Founded in part on WÜNSCHEN-DORFF'S "Traité de Télégraphie Sous-Marine," and Compiled from Authoritative and Exclusive Sources. By CHARLES BRIGHT, F.R.S.E. Royal 8vo, 780 pp., fully Illustrated, including Maps and Folding Plates. *Net £3 3s.*

"There are few, if any, persons more fitted to write a treatise on submarine telegraphy than Mr. Charles Bright. The author has done his work admirably, and has written in a way which will appeal as much to the layman as to the engineer. This admirable volume must, for many years to come, hold the position of the English classic on submarine telegraphy."—*Engineer.*

"Mr. Bright's interestingly written and admirably illustrated book will meet with a welcome reception from cable men."—*Electrician.*

"The author deals with his subject from all points of view—political and strategical as well as scientific. The work will be of interest, not only to men of science, but to the general public. We can strongly recommend it."—*Athenæum.*

DYNAMO ELECTRIC MACHINERY: its CONSTRUCTION, DESIGN, and OPERATION.

By SAMUEL SHELDON, A.M., Ph.D., Professor of Physics and Electrical Engineering at the Polytechnic Institute of Brooklyn, assisted by HOBART MASON, B.S.

In two volumes, sold separately, as follows:—

Vol. I.—DIRECT CURRENT MACHINES. Third Edition, Revised. Large crown 8vo. 280 pages, with 200 Illustrations.

[Just Published. Net 12/0

Vol. II.—ALTERNATING CURRENT MACHINES. Large crown 8vo. 260 pages, with 184 Illustrations.

[Just Published. Net 12/0

Designed as Text-books for use in Technical Educational Institutions, and by Engineers whose work includes the handling of Direct and Alternating Current Machines respectively, and for Students proficient in mathematics.

THE ELECTRICAL ENGINEER'S POCKET-BOOK.

Consisting of Modern Rules, Formulæ, Tables, and Data. By H. R. KEMPE, M.Inst.E.E., A.M.Inst.C.E., Technical Officer Postal Telegraphs, Author of "A Handbook of Electrical Testing," &c. Second Edition, Revised, with Additions. With numerous Illustrations. Royal 32mo, oblong, leather 5/0

"It is the best book of its kind."—*Electrical Engineer.*
 "The Electrical Engineer's Pocket-Book is a good one."—*Electrician.*
 "Strongly recommended to those engaged in the electrical industries."—*Electrical Review.*

ELECTRIC LIGHT FITTING.

A Handbook for Working Electrical Engineers, embodying Practical Notes on Installation Management. By J. W. URQUHART. With numerous Illustrations. Third Edition, Revised. Crown 8vo, cloth 5/0

"This volume deals with what may be termed the mechanics of electric lighting, and is addressed to men who are already engaged in the work, or are training for it. The work traverses a great deal of ground, and may be read as a sequel to the same author's useful work on 'Electric Light.'"—*Electrician.*

ELECTRIC LIGHT.

Its Production and Use, Embodying Plain Directions for the Treatment of Dynamo-Electric Machines, Batteries, Accumulators, and Electric Lamps. By J. W. URQUHART, C.E. Sixth Edition, Revised, with Additions and 145 Illustrations. Crown 8vo, cloth. *[Just Published. 7/6*

"The whole ground of electric lighting is more or less covered and explained in a very clear and concise manner."—*Electrical Review.*

"A *vide-mecum* of the salient facts connected with the science of electric lighting."—*Electrician.*

DYNAMO CONSTRUCTION.

A Practical Handbook for the Use of Engineer-Constructors and Electricians-in-Charge. Embracing Framework Building, Field Magnet and Armature Winding and Grouping, Compounding, &c. By J. W. URQUHART. Second Edition, Enlarged. Crown 8vo, cloth 7/6

"Mr. Urquhart's book is the first one which deals with these matters in such a way that the engineering student can understand them. The book is very readable, and the author leads his readers up to difficult subjects by reasonably simple tests."—*Engineering Review.*

ELECTRICAL AND MAGNETIC CALCULATIONS.

For the Use of Electrical Engineers and Artisans, Teachers, Students, and all others interested in the Theory and Application of Electricity and Magnetism. By A. A. ATKINSON, Professor of Electricity in Ohio University. Crown 8vo, cloth. *[Just Published. Net 9/0]*

THE ELEMENTS OF ELECTRICAL ENGINEERING.

A First Year's Course for Students and Workmen By TYSON SEWELL, A I.E.E., Assistant Lecturer and Demonstrator in Electrical Engineering at the Polytechnic Regent Street, London. With upwards of 200 Illustrations. Demy 8vo, cloth. *[Just Published. Net 7/6]*

THE MANAGEMENT OF DYNAMOS.

A Handy Book of Theory and Practice for the Use of Mechanics, Engineers, Students, and others in Charge of Dynamos. By G. W. LUMMIS-PATERSON. Second Edition, thoroughly Revised and Enlarged. Crown 8vo, cloth. **4/6**
 "An example which deserves to be taken as a model by other authors. The subject is treated in a manner which any intelligent man who is fit to be entrusted with charge of an engine should be able to understand. It is a useful book to all who make, tend, or employ electric machinery."
—Architect.

THE STANDARD ELECTRICAL DICTIONARY.

A Popular Encyclopædia of Words and Terms Used in the Practice of Electrical Engineering. By T. O'CONNOR SLOANE, A.M., Ph.D. Third Edition, with Appendix. Crown 8vo, 680 pp., 390 Illustrations, cloth. *Net 7/6*
 "The work has many attractive features in it, and is, beyond doubt, a well put together and useful publication. The amount of ground covered may be gathered from the fact that in the index about 5,600 references will be found."
—Electrical Review.

ELECTRIC SHIP-LIGHTING.

A Handbook on the Practical Fitting and Running of Ships' Electrical Plant. For the Use of Shipowners and Builders, Marine Electricians, and Seagoing Engineers-in-Charge. By J. W. URQUHART, C.E. Second Edition, Revised and Extended. 326 pp., with 88 Illustrations, Crown 8vo, cloth. **7/6**
 "The subject of ship electric lighting is one of vast importance, and Mr. Urquhart is to be highly complimented for placing such a valuable work at the service of marine electricians."
—The Steamship.

ELECTRIC LIGHT FOR COUNTRY HOUSES.

A Practical Handbook on the Erection and Running of Small Installations, with Particulars of the Cost of Plant and Working. By J. H. KNIGHT. Third Edition, Revised. Crown 8vo, wrapper. *[Just Published. 1/0]*

ELECTRIC LIGHTING (ELEMENTARY PRINCIPLES OF).

By ALAN A. CAMPBELL SWINTON, M.Inst.C.E., M.Inst.E.E. Fourth Edition, Revised. With 16 Illustrations. Crown 8vo, cloth. *[Just Published. 1/6]*

DYNAMIC ELECTRICITY AND MAGNETISM.

By PHILIP ATKINSON, A.M., Ph.D., Author of "Elements of Static Electricity," &c. Crown 8vo, 417 pp., with 120 Illustrations, cloth. **10/6**

POWER TRANSMITTED BY ELECTRICITY

And applied by the Electric Motor, including Electric Railway Construction. By P. ATKINSON, A.M., Ph.D. Third Edition, Fully Revised, and New Matter added. With 94 Illustrations. Crown 8vo, cloth. *Net 9/0*

HOW TO MAKE A DYNAMO.

A Practical Treatise for Amateurs. Containing numerous Illustrations and Detailed Instructions for Constructing a Small Dynamo to Produce the Electric Light. By ALFRED CROFTS. Sixth Edition, Revised and Enlarged. Crown 8vo, cloth. *[Just Published. 2/0]*

THE STUDENT'S TEXT-BOOK OF ELECTRICITY.

By H. M. NOAD, F.R.S. Cheaper Edition. 650 pp., with 470 Illustrations. Crown 8vo, cloth. **9/0**

ARCHITECTURE, BUILDING, &c.

PRACTICAL BUILDING CONSTRUCTION.

A Handbook for Students Preparing for Examinations, and a Book of Reference for Persons Engaged in Building. By JOHN PARNELL ALLEN, Surveyor, Lecturer on Building Construction at the Durham College of Science, Newcastle-on-Tyne. Third Edition, Revised and Enlarged. Medium 8vo, 450 pp., with 1,000 Illustrations, cloth. [Just Published. 7/6

"The most complete exposition of building construction we have seen. It contains all that is necessary to prepare students for the various examinations in building construction."—*Building News*.

"The author depends nearly as much on his diagrams as on his type. The pages suggest the hand of a man of experience in building operations—and the volume must be a blessing to many teachers as well as to students."—*The Architect*.

"The work is sure to prove a formidable rival to great and small competitors alike, and bids fair to take a permanent place as a favourite student's text-book. The large number of illustrations deserve particular mention for the great merit they possess for purposes of reference in exactly corresponding to convenient scales."—*Journal of the Royal Institute of British Architects*.

PRACTICAL MASONRY.

A Guide to the Art of Stone Cutting. Comprising the Construction, Setting Out, and Working of Stairs, Circular Work, Arches, Niches, Domes, Pendentives, Vaults, Tracery Windows, &c., &c. For the Use of Students, Masons, and other Workmen. By WILLIAM R. PURCHASE, Building Inspector to the Borough of Hove. Third Edition, with Glossary of Terms. Royal 8vo, 142 pp., with 52 Lithographic Plates, comprising nearly 400 separate Diagrams, cloth. [Just Published. 7/6

"Mr. Purchase's 'Practical Masonry' will undoubtedly be found useful to all interested in this important subject, whether theoretically or practically. Most of the examples given are from actual work carried out, the diagrams being carefully drawn. The book is a practical treatise on the subject, the author himself having commenced as an operative mason, and afterwards acted as foreman mason on many large and important buildings prior to the attainment of his present position. It should be found of general utility to architectural students and others, as well as to those to whom it is specially addressed."—*Journal of the Royal Institute of British Architects*.

MODERN PLUMBING, STEAM AND HOT WATER HEATING.

A New Practical Work for the Plumber, the Heating Engineer, the Architect, and the Builder. By J. J. LAWLER, Author of "American Sanitary Plumbing," &c. With 284 Illustrations and Folding Plates. 4to, cloth.

[Just Published. Net 21/-

HEATING BY HOT WATER.

With Information and Suggestions on the best Methods of Heating Public, Private and Horticultural Buildings. By WALTER JONES. Second Edition. With 96 Illustrations, crown 8vo, cloth Net 2/6

"We confidently recommend all interested in heating by hot water to secure a copy of this valuable little treatise."—*The Plumber and Decorator*.

CONCRETE: ITS NATURE AND USES.

A Book for Architects, Builders, Contractors, and Clerks of Works. By GEORGE L. SUTCLIFFE, A.R.I.B.A. 350 pp., with numerous Illustrations. Crown 8vo, cloth 7/6

"The author treats a difficult subject in a lucid manner. The manual fills a long-felt gap. It is careful and exhaustive; equally useful as a student's guide and an architect's book of reference."—*Journal of the Royal Institute of British Architects*.

"There is room for this new book, which will probably be for some time the standard work on the subject for a builder's purpose."—*Glasgow Herald*.

LOCKWOOD'S BUILDER'S PRICE BOOK for 1902.

A Comprehensive Handbook of the Latest Prices and Data for Builders, Architects, Engineers, and Contractors. Re-constructed, Re-written, and Greatly Enlarged. By FRANCIS T. W. MILLER. 800 closely-printed pages, crown 8vo, cloth 4/0

"This book is a very useful one, and should find a place in every English office connected with the building and engineering professions."—*Industries*.

"An excellent book of reference."—*Architect*.

"In its new and revised form this Price Book is what a work of this kind should be—comprehensive, reliable, well arranged, legible, and well bound."—*British Architect*.

THE DECORATIVE PART OF CIVIL ARCHITECTURE.

By Sir WILLIAM CHAMBERS, F.R.S. With Portrait, Illustrations, Notes, and an EXAMINATION OF GREEK ARCHITECTURE, by JOSEPH GWILT, F.S.A. Revised and Edited by W. H. LEEDE. 66 Plates, 4to, cloth . . . 21/0

THE MECHANICS OF ARCHITECTURE.

A Treatise on Applied Mechanics, especially Adapted to the Use of Architects. By E. W. TARN, M.A., Author of "The Science of Building," &c. Second Edition, Enlarged. Illustrated with 125 Diagrams. Crown 8vo, cloth 7/6

"The book is a very useful and helpful manual of architectural mechanics."—*Builder*.

A HANDY BOOK OF VILLA ARCHITECTURE.

Being a Series of Designs for Villa Residences in various Styles. With Outline Specifications and Estimates. By C. WICKES, Architect. 6r Plates, 4to, half-morocco, gilt edges . . . £1 11s. 6s.

"The whole of the designs bear evidence of their being the work of an artistic architect, and they will prove very valuable and suggestive."—*Building News*.

THE ARCHITECT'S GUIDE.

Being a Text-book of Useful Information for Architects, Engineers, Surveyors, Contractors, Clerks of Works, &c., &c. By FREDERICK ROGERS, Architect. Third Edition. Crown 8vo, cloth . . . 3/6

ARCHITECTURAL PERSPECTIVE.

The whole Course and Operations of the Draughtsman in Drawing a Large House in Linear Perspective. Illustrated by 43 Folding Plates. By F. O. FERGUSON. Second Edition, Enlarged. 8vo, boards . . . 3/6

"It is the most intelligible of the treatises on this ill-treated subject that I have met with."—E. INGRESS BELL, ESQ., in the *R.I.B.A. Journal*

PRACTICAL RULES ON DRAWING.

For the Operative Builder and Young Student in Architecture. By GEORGE PYNE. 14 Plates, 4to, boards . . . 7/6

MEASURING AND VALUING ARTIFICER'S WORK

(The Student's Guide to the Practice of). Containing Directions for taking Dimensions, Abstracting the same, and bringing the Quantities into Bill, with Tables of Constants for Valuation of Labour, and for the Calculation of Areas and Solidities. Originally edited by E. DOBSON, Architect. With Additions by E. W. TARN, M.A. Seventh Edition, Revised. With 8 Plates and 63 Woodcuts. Crown 8vo, cloth. [Just Published. 7/6

"This edition will be found the most complete treatise on the principles of measuring and valuing artificer's work that has yet been published."—*Building News*.

TECHNICAL GUIDE, MEASURER, AND ESTIMATOR.

For Builders and Surveyors. Containing Technical Directions for Measuring Work in all the Building Trades, Complete Specifications for Houses, Roads, and Drains, and an Easy Method of Estimating the parts of a Building collectively. By A. C. BEATON. Ninth Edition. Waistcoat-pocket size, gilt edges . . . 1/6

"No builder, architect, surveyor, or valuer should be without his 'Beaton.'"—*Building News*.

SPECIFICATIONS FOR PRACTICAL ARCHITECTURE.

A Guide to the Architect, Engineer, Surveyor, and Builder. With an Essay on the Structure and Science of Modern Buildings. Upon the Basis of the Work by ALFRED BARTHOLOMEW, thoroughly Revised, Corrected, and greatly added to by FREDERICK ROGERS, Architect. Third Edition, Revised. 8vo, cloth . . . 15/0

"The work is too well known to need any recommendation from us. It is one of the books with which every young architect must be equipped."—*Architect*.

THE HOUSE-OWNER'S ESTIMATOR.

Or, What will it Cost to Build, Alter, or Repair? A Price Book for Un-professional People as well as the Architectural Surveyor and Builder. By J. D. SIMON. Edited by F. T. W. MILLER, A.R.I.B.A. Fifth Edition. Carefully Revised. Crown 8vo, cloth. [Just Published. Net 3/6

"In two years it will repay its cost a hundred times over."—*Field*.

SANITATION AND WATER SUPPLY.

THE BACTERIAL PURIFICATION OF SEWAGE:

Being a Practical Account of the Various Modern Biological Methods of Purifying Sewage. By SIDNEY BARWISE, M.D. (Lond.), D.P.H. (Camb.), etc. With 10 Page Plates and 2 Folding Diagrams. Royal 8vo, cloth.

[Just Published. Net 6/0

THE PURIFICATION OF SEWAGE.

Being a Brief Account of the Scientific Principles of Sewage Purification, and their Practical Application. By SIDNEY BARWISE, M.D. (Lond.), M.R.C.S., D.P.H. (Camb.), Fellow of the Sanitary Institute, Medical Officer of Health to the Derbyshire County Council. Crown 8vo, cloth. [Just Published. 5/0

WATER AND ITS PURIFICATION.

A Handbook for the Use of Local Authorities, Sanitary Officers, and others interested in Water Supply. By S. RIDEAL, D.Sc. Lond., F.I.C. Second Edition, Revised, with Additions, including numerous Illustrations and Tables. Large Crown 8vo, cloth. [Just Published. Net 9/0

RURAL WATER SUPPLY.

A Practical Handbook on the Supply of Water and Construction of Water-works for Small Country Districts. By ALLAN GREENWELL, A.M.I.C.E., and W. T. CURRY, A.M.I.C.E. Revised Edition. Crown 8vo, cloth 5/0

THE WATER SUPPLY OF CITIES AND TOWNS.

By WILLIAM HUMBER, A.M. Inst. C.E., and M.Inst. M.E. Imp. 4to, half-bound morocco. (See page 11.) Net 28 6s.

THE WATER SUPPLY OF TOWNS AND THE CONSTRUCTION OF WATER-WORKS.

By PROFESSOR W. K. BURTON, A.M. Inst. C.E. Second Edition, Revised and Extended. Royal 8vo, cloth. (See page 10.) 25/0

WATER ENGINEERING.

A Practical Treatise on the Measurement, Storage, Conveyance, and Utilisation of Water for the Supply of Towns. By C. SLAGG, A.M. Inst. C.E. 7/6

SANITARY WORK IN SMALL TOWNS AND VILLAGES.

By CHARLES SLAGG, A. M. Inst. C.E. Crown 8vo, cloth 3/0

SANITARY ARRANGEMENT OF DWELLING-HOUSES.

By A. J. WALLIS-TAYLER, A.M.Inst.C.E. Crown 8vo, cloth 2/6

MODERN PLUMBING, HOT WATER HEATING, &c.

A New Practical Work for the Plumber, the Heating Engineer, the Architect, and the Builder. By J. J. LAWLER, Author of "American Sanitary Plumbing," &c. With 284 Illustrations and Folding Plates. 4to, cloth.

[Just Published (see page 25). Net 21/-

PLUMBING.

A Text-book to the Practice of the Art or Craft of the Plumber. By W. P. BUCHAN, R.P. Ninth Edition, Enlarged. Crown 8vo, cloth 3/6

VENTILATION.

A Text-book to the Practice of the Art of Ventilating Buildings. By W. P. BUCHAN, R.P. Crown 8vo, cloth 3/6

THE HEALTH OFFICER'S POCKET-BOOK.

A Guide to Sanitary Practice and Law. For Medical Officers of Health, Sanitary Inspectors, Members of Sanitary Authorities, &c. By EDWARD F. WILLOUGHBY, M.D. (Lond.), &c. Second Edition, Revised and Enlarged. Fcap. 8vo, leather. [Just Published. Net 10/6

CARPENTRY, TIMBER, &c.

THE ELEMENTARY PRINCIPLES OF CARPENTRY.

A Treatise on the Pressure and Equilibrium of Timber Framing, the Resistance of Timber, and the Construction of Floors, Arches, Bridges, Roofs, Uniting Iron and Stone with Timber, &c. To which is added an Essay on the Nature and Properties of Timber, &c., with Descriptions of the kinds of Wood used in Building; also numerous Tables of the Scantlings of Timber for different purposes, the Specific Gravities of Materials, &c. By THOMAS TREGOLD, C.E. With an Appendix of Specimens of Various Roofs of Iron and Stone, Illustrated. Seventh Edition, thoroughly Revised and considerably Enlarged by E. WYNDHAM TARN, M.A., Author of "The Science of Building," &c. With 61 Plates, Portrait of the Author, and several Woodcuts. In One large Vol., 4to, cloth 25/0

"Ought to be in every architect's and every builder's library."—*Builder*.

"A work whose monumental excellence must commend it wherever skilful carpentry is concerned. The author's principles are rather confirmed than impaired by time. The additional plates are of great intrinsic value."—*Building News*.

WOODWORKING MACHINERY.

Its Rise, Progress, and Construction. With Hints on the Management of Saw Mills and the Economical Conversion of Timber. Illustrated with Examples of Recent Designs by leading English, French, and American Engineers. By M. POWIS BALE, A.M.Inst.C.E., M.I.M.E. Second Edition, Revised, with large Additions, large crown 8vo, 440 pp., cloth 9/0

"Mr. Bale is evidently an expert on the subject, and he has collected so much information that his book is all-sufficient for builders and others engaged in the conversion of timber."—*Architect*.

"The most comprehensive compendium of wood-working machinery we have seen. The author is a thorough master of his subject."—*Building News*.

SAW MILLS.

Their Arrangement and Management, and the Economical Conversion of Timber. By M. POWIS BALE, A.M.Inst.C.E. Second Edition, Revised. Crown 8vo, cloth. [Just Published. 10/6

"The administration of a large sawing establishment is discussed, and the subject examined from a financial standpoint. Hence the size, shape, order, and disposition of saw mills and the like are gone into in detail, and the course of the timber is traced from its reception to its delivery in its converted state. We could not desire a more complete or practical treatise."—*Builder*.

THE CARPENTER'S GUIDE.

Or, Book of Lines for Carpenters; comprising all the Elementary Principles essential for acquiring a knowledge of Carpentry. Founded on the late PETER NICHOLSON'S standard work. A New Edition, Revised by ARTHUR ASHPITEL, F.S.A. Together with Practical Rules on Drawing, by GEORGE PYNE. With 74 Plates, 4to, cloth 21 1s.

A PRACTICAL TREATISE ON HANDRAILING.

Showing New and Simple Methods for Finding the Pitch of the Plank, Drawing the Moulds, Beveling, Jointing-up, and Squaring the Wreath. By GEORGE COLLINGS. Second Edition, Revised and Enlarged, to which is added A TREATISE ON STAIR-BUILDING. With Plates and Diagrams 2/6

"Will be found of practical utility in the execution of this difficult branch of joinery."—*Builder*.

"Almost every difficult phase of this somewhat intricate branch of joinery is elucidated by the aid of plates and explanatory letterpress."—*Furniture Gazette*.

CIRCULAR WORK IN CARPENTRY AND JOINERY.

A Practical Treatise on Circular Work of Single and Double Curvature. By GEORGE COLLINGS. With Diagrams. Third Edition, 12mo, cloth 2/6

"An excellent example of what a book of this kind should be. Cheap in price, clear in definition, and practical in the examples selected."—*Builder*.

THE CABINET-MAKER'S GUIDE TO THE ENTIRE CONSTRUCTION OF CABINET WORK.

By RICHARD BITMEAD. Illustrated with Plans, Sections and Working Drawings. Crown 8vo, cloth. [Just Published. 2/6

HANDRAILING COMPLETE IN EIGHT LESSONS.

On the Square-Cut System. By J. S. GOLDTHORP, Head of Building Department, Halifax Technical School. With Eight Plates and over 150 Practical Exercises. 4to, cloth 3/6

"Likely to be of considerable value to joiners and others who take a pride in good work. The arrangement of the book is excellent. We heartily commend it to teachers and students."—*Timber Trades Journal*.

TIMBER MERCHANT'S and BUILDER'S COMPANION.

Containing New and Copious Tables of the Reduced Weight and Measurement of Deals and Battens, of all sizes, from One to a Thousand Pieces, and the relative Price that each size bears per Lineal Foot to any given Price per Petersburg Standard Hundred; the Price per Cube Foot of Square Timber to any given Price per Load of 50 Feet, &c., &c. By WILLIAM DOWSING. Fourth Edition, Revised and Corrected. Crown 8vo, cloth 3/0

"We are glad to see a fourth edition of these admirable tables, which for correctness and simplicity of arrangement leave nothing to be desired."—*Timber Trades Journal*.

THE PRACTICAL TIMBER MERCHANT.

A Guide for the Use of Building Contractors, Surveyors, Builders, &c., comprising useful Tables for all purposes connected with the Timber Trade, Marks of Wood, Essay on the Strength of Timber, Remarks on the Growth of Timber, &c. By W. RICHARDSON. Second Edition. Fcap. 8vo, cloth . . . 3/6

"Contains much valuable information for timber merchants, builders, foresters, and all others connected with the growth, sale, and manufacture of timber."—*Journal of Forestry*.

PACKING-CASE TABLES.

Showing the number of Superficial Feet in Boxes or Packing-Cases, from six inches square and upwards. By W. RICHARDSON, Timber Broker. Third Edition. Oblong 4to, cloth 3/6

"Invaluable labour-saving tables."—*Ironmonger*.

GUIDE TO SUPERFICIAL MEASUREMENT.

Tables calculated from 1 to 200 inches in length by 1 to 108 inches in breadth. For the use of Architects, Surveyors, Engineers, Timber Merchants, Builders, &c. By JAMES HAWKINGS. Fifth Edition. Fcap., cloth. 3/6

"A useful collection of tables to facilitate rapid calculation of surfaces. The exact area of any surface of which the limits have been ascertained can be instantly determined. The book will be found of the greatest utility to all engaged in building operations."—*Scotsman*.

PRACTICAL FORESTRY.

And its Bearing on the Improvement of Estates. By CHARLES E. CURTIS, F.S.I., Professor of Forestry, Field Engineering, and General Estate Management, at the College of Agriculture, Downton. Second Edition, Revised. Crown 8vo, cloth. [Just Published. 3/6

SUMMARY OF CONTENTS:—PREFATORY REMARKS.—OBJECTS OF PLANTING.—CHOICE OF A FORESTER.—CHOICE OF SOIL AND SITE.—LAYING OUT OF LAND FOR PLANTATIONS.—PREPARATION OF THE GROUND FOR PLANTING.—DRAINAGE.—PLANTING.—DISTANCES AND DISTRIBUTION OF TREES IN PLANTATIONS.—TREES AND GROUND GAME.—ATTENTION AFTER PLANTING.—THINNING OF PLANTATIONS.—PRUNING OF FOREST TREES.—REALIZATION.—METHODS OF SALE.—MEASUREMENT OF TIMBER.—MEASUREMENT AND VALUATION OF LARCH PLANTATION.—FIRE LINES.—COST OF PLANTING.

"Mr. Curtis has in the course of a series of short pithy chapters afforded much information of a useful and practical character on the planting and subsequent treatment of trees."—*Illustrated Carpenter and Builder*.

THE ELEMENTS OF FORESTRY.

Designed to afford Information concerning the Planting and Care of Forest Trees for Ornament or Profit, with suggestions upon the Creation and Care of Woodlands. By F. B. HOUGH. Large crown 8vo, cloth 10/0

THE TIMBER IMPORTER'S, TIMBER MERCHANT'S, AND BUILDER'S STANDARD GUIDE.

By RICHARD E. GRANDY. Comprising:—An Analysis of Deal Standards, Home and Foreign, with Comparative Values and Tabular Arrangements for fixing Net Landed Cost on Baltic and North American Deals, including all intermediate Expenses, Freight, Insurance, &c.; together with copious Information for the Retailer and Builder. Third Edition. 12mo, cloth 2/0

DECORATIVE ARTS, &c.

SCHOOL OF PAINTING FOR THE IMITATION OF WOODS AND MARBLES.

As Taught and Practised by A. R. VAN DER BURG and P. VAN DER BURG, Directors of the Rotterdam Painting Institution. Royal folio, 18 $\frac{1}{2}$ by 12 $\frac{1}{2}$ in., Illustrated with 24 full-size Coloured Plates; also 12 plain Plates, comprising 154 Figures. Third Edition, cloth. [Just Published. £1 11s. 6s.]

LIST OF PLATES:—1. VARIOUS TOOLS REQUIRED FOR WOOD PAINTING.—2, 3. WALNUT; PRELIMINARY STAGES OF GRAINING AND FINISHED SPECIMEN.—4. TOOLS USED FOR MARBLE PAINTING AND METHOD OF MANIPULATION.—5. ST. REMI MARBLE; EARLIER OPERATIONS AND FINISHED SPECIMEN.—7. METHODS OF SKETCHING DIFFERENT GRAINS, KNOTS, &c.—8, 9. ASH; PRELIMINARY STAGES AND FINISHED SPECIMEN.—10. METHODS OF SKETCHING MARBLE GRAINS.—11, 12. BRECHE MARBLE; PRELIMINARY STAGES OF WORKING AND FINISHED SPECIMEN.—13. MAPLE; METHODS OF PRODUCING THE DIFFERENT GRAINS.—14, 15. BIRD'S-EYE MAPLE; PRELIMINARY STAGES AND FINISHED SPECIMEN.—16. METHODS OF SKETCHING THE DIFFERENT SPECIES OF WHITE MARBLE.—17, 18. WHITE MARBLE; PRELIMINARY STAGES OF PROCESS AND FINISHED SPECIMEN.—19. MAHOGANY; SPECIMENS OF VARIOUS GRAINS AND METHODS OF MANIPULATION.—20, 21. MAHOGANY; EARLIER STAGES AND FINISHED SPECIMEN.—22, 23, 24. SIENNA MARBLE; VARIETIES OF GRAIN, PRELIMINARY STAGES AND FINISHED SPECIMEN.—25, 26, 27. JUNIPER WOOD; METHODS OF PRODUCING GRAIN, &c.; PRELIMINARY STAGES AND FINISHED SPECIMEN.—28, 29, 30. VERT DE MER MARBLE; VARIETIES OF GRAIN AND METHODS OF WORKING, UNFINISHED AND FINISHED SPECIMENS.—31, 32, 33. OAK; VARIETIES OF GRAIN, TOOLS EMPLOYED AND METHODS OF MANIPULATION, PRELIMINARY STAGES AND FINISHED SPECIMEN.—34, 35, 36. WAULSORT MARBLE; VARIETIES OF GRAIN, UNFINISHED AND FINISHED SPECIMENS.

"Those who desire to attain skill in the art of painting woods and marbles will find advantage in consulting this book. . . . Some of the Working Men's Clubs should give their young men the opportunity to study it."—*Builder*.

"A comprehensive guide to the art. The explanations of the processes, the manipulation and management of the colours, and the beautifully executed plates will not be the least valuable to the student who aims at making his work a faithful transcript of nature."—*Building News*.

"Students and novices are fortunate who are able to become the possessors of so noble a work."—*The Architect*.

ELEMENTARY DECORATION.

A Guide to the Simpler Forms of Everyday Art. Together with PRACTICAL HOUSE DECORATION. By JAMES W. FACEY. With numerous Illustrations. In One Vol., strongly half-bound 5/0

HOUSE PAINTING, GRAINING, MARBLING, AND SIGN WRITING.

A Practical Manual of. By ELLIS A. DAVIDSON. Eighth Edition. With Coloured Plates and Wood Engravings. 12mo, cloth boards 6/0

"A mass of information of use to the amateur and of value to the practical man."—*English Mechanic*.

THE DECORATOR'S ASSISTANT.

A Modern Guide for Decorative Artists and Amateurs, Painters, Writers, Gilders, &c. Containing upwards of 600 Receipts, Rules, and Instructions; with a variety of Information for General Work connected with every Class of Interior and Exterior Decorations, &c. Seventh Edition. 152 pp., cr. 8vo. 1/0

"Full of receipts of value to decorators, painters, gilders, &c. The book contains the gist of larger treatises on colour and technical processes. It would be difficult to meet with a work so full of varied information on the painter's art."—*Building News*.

MARBLE DECORATION

And the Terminology of British and Foreign Marbles. A Handbook for Students. By GEORGE H. BLAGROVE, Author of "Shoring and its Application," &c. With 28 Illustrations. Crown 8vo, cloth 3/6

"This most useful and much wanted handbook should be in the hands of every architect and builder."—*Building World*.

"A carefully and usefully written treatise; the work is essentially practical."—*Sootsman*.

DELAMOTTE'S WORKS ON ALPHABETS AND ILLUMINATION.

ORNAMENTAL ALPHABETS, ANCIENT & MÆDIÆVAL.

From the Eighth Century, with Numerals; including Gothic, Church-Text, large and small, German, Italian, Arabesque, Initials for Illumination, Monograms, Crosses, &c., &c., for the use of Architectural and Engineering Draughtsmen, Missal Painters, Masons, Decorative Painters, Lithographers, Engravers, Carvers, &c., &c. Collected and Engraved by F. DELAMOTTE, and printed in Colours. New and Cheaper Edition. Royal 8vo, oblong, ornamental boards 2/6

"For those who insert enamelled sentences round gilded chalices, who blazon shop legends over shop-doors, who letter church walls with pithy sentences from the Decalogue, this book will be useful."—*Athenæum*.

MODERN ALPHABETS, PLAIN AND ORNAMENTAL.

Including German, Old English, Saxon, Italic, Perspective, Greek, Hebrew, Court Hand, Engrossing, Tuscan, Riband, Gothic, Rustic, and Arabesque; with several Original Designs, and an Analysis of the Roman and Old English Alphabets, large and small, and Numerals, for the use of Draughtsmen, Surveyors, Masons, Decorative Painters, Lithographers, Engravers, Carvers, &c. Collected and Engraved by F. DELAMOTTE, and printed in Colours. New and Cheaper Edition. Royal 8vo, oblong, ornamental boards 2/6

"There is comprised in it every possible shape into which the letters of the alphabet and numerals can be formed, and the talent which has been expended in the conception of the various plain and ornamental letters is wonderful."—*Standard*.

MÆDIÆVAL ALPHABETS AND INITIALS FOR ILLUMINATORS.

By F. G. DELAMOTTE. Containing 21 Plates and Illuminated Title, printed in Gold and Colours. With an Introduction by J. WILLIS BROOKS. Fourth and Cheaper Edition. Small 4to, ornamental boards 4/0

"A volume in which the letters of the alphabet come forth glorified in gilding and all the colours of the prism interwoven and intertwined and intermingled."—*Sun*.

A PRIMER OF THE ART OF ILLUMINATION.

For the Use of Beginners; with a Rudimentary Treatise on the Art, Practical Directions for its Exercise, and Examples taken from Illuminated MSS., printed in Gold and Colours. By F. DELAMOTTE. New and Cheaper Edition. Small 4to, ornamental boards 6/0

"The examples of ancient MSS. recommended to the student, which, with much good sense, the author chooses from collections accessible to all, are selected with judgment and knowledge as well as taste."—*Athenæum*.

THE EMBROIDERER'S BOOK OF DESIGN.

Containing Initials, Emblems, Cyphers, Monograms, Ornamental Borders, Ecclesiastical Devices, Mædiæval and Modern Alphabets, and National Emblems. Collected by F. DELAMOTTE, and printed in Colours. Oblong royal 8vo, ornamental wrapper 1/6

"The book will be of great assistance to ladies and young children who are endowed with the art of plying the needle in this most ornamental and useful pretty work."—*East Anglian Times*.

INSTRUCTIONS IN WOOD-CARVING FOR AMATEURS.

With Hints on Design. By A LADY. With 10 Plates. New and Cheaper Edition. Crown 8vo, in emblematic wrapper 2/0

"The handicraft of the wood-carver, so well as a book can impart it, may be learnt from 'A Lady's' publication."—*Athenæum*.

PAINTING POPULARLY EXPLAINED.

By THOMAS JOHN GULLICK, Painter, and JOHN TIMBS, F.S.A. Including Fresco, Oil, Mosaic, Water-Colour, Water-Glass, Tempera, Encaustic, Miniature, Painting on Ivory, Vellum, Pottery, Enamel, Glass, &c. Fifth Edition. Crown 8vo, cloth 5/0

, Adopted as a Prize Book at South Kensington.

"Much may be learned, even by those who fancy they do not require to be taught, from the careful perusal of this unpretending but comprehensive treatise."—*Art Journal*.

NATURAL SCIENCE, &c.

THE VISIBLE UNIVERSE.

Chapters on the Origin and Construction of the Heavens. By J. E. GORE, F.R.A.S., Author of "Star Groups," &c. Illustrated by 6 Stellar Photographs and 12 Plates. Demy 8vo, cloth 16/0

"A valuable and lucid summary of recent astronomical theory, rendered more valuable and attractive by a series of stellar photographs and other illustrations."—*The Times*.

"In presenting a clear and concise account of the present state of our knowledge Mr. Gore has made a valuable addition to the literature of the subject."—*Nature*.

"Mr. Gore's 'Visible Universe' is one of the finest works on astronomical science that have recently appeared in our language. In spirit and in method it is scientific from cover to cover, but the style is so clear and attractive that it will be as acceptable and as readable to those who make no scientific pretensions as to those who devote themselves specially to matters astronomical."—*Leeds Mercury*.

STAR GROUPS.

A Student's Guide to the Constellations. By J. ELLARD GORE, F.R.A.S., M.R.I.A., &c., Author of "The Visible Universe," "The Scenery of the Heavens," &c. With 30 Maps. Small 4to, cloth 5/0

"The volume contains thirty maps showing stars of the sixth magnitude—the usual naked-eye limit—and each is accompanied by a brief commentary adapted to facilitate recognition and bring to notice objects of special interest. For the purpose of a preliminary survey of the 'midnight pomp' of the heavens nothing could be better than a set of delineations averaging scarcely twenty square inches in area and including nothing that cannot at once be identified."—*Saturday Review*.

AN ASTRONOMICAL GLOSSARY.

Or, Dictionary of Terms used in Astronomy. With Tables of Data and Lists of Remarkable and Interesting Celestial Objects. By J. ELLARD GORE, F.R.A.S., Author of "The Visible Universe," &c. Small crown 8vo, cloth. 2/6

"A very useful little work for beginners in astronomy, and not to be despised by more advanced students."—*The Times*.

"A very handy book . . . the utility of which is much increased by its valuable tables of astronomical data."—*Athenæum*.

THE MICROSCOPE.

Its Construction and Management. Including Technique, Photo-micrography, and the Past and Future of the Microscope. By Dr. HENRI VAN HEURCK. Re-Edited and Augmented from the Fourth French Edition, and Translated by WYNNE E. BAXTER, F.G.S. 400 pp., with upwards of 250 Woodcuts, imp. 8vo, cloth 18/0

"A translation of a well-known work, at once popular and comprehensive."—*Times*.

"The translation is as felicitous as it is accurate."—*Nature*.

ASTRONOMY.

By the late Rev. ROBERT MAIN, M.A., F.R.S. Third Edition, Revised by WILLIAM THYNNE LYNN, B.A., F.R.A.S., formerly of the Royal Observatory, Greenwich. 12mo, cloth 2/0

"A sound and simple treatise, very carefully edited, and a capital book for beginners."—*Knowledge*.

"Accurately brought down to the requirements of the present time by Mr. Lynn."—*Educational Times*.

A MANUAL OF THE MOLLUSCA.

A Treatise on Recent and Fossil Shells. By S. P. WOODWARD, A.L.S., F.G.S. With an Appendix on RECENT AND FOSSIL CONCHOLOGICAL DISCOVERIES, by RALPH TATE, A.L.S., F.G.S. With 23 Plates and upwards of 300 Woodcuts. Reprint of Fourth Edition (1880). Crown 8vo, cloth 7/6

"A most valuable storehouse of conchological and geological information."—*Science Gossip*.

THE TWIN RECORDS OF CREATION.

Or, Geology and Genesis, their Perfect Harmony and Wonderful Concord. By G. W. V. LE VAUX. 8vo, cloth 5/0

"A valuable contribution to the evidences of Revelation, and disposes very conclusively of the arguments of those who would set God's Works against God's Word. No real difficulty is shirked, and no sophistry is left unexposed."—*The Rock*.

HANDBOOK OF MECHANICS.

By Dr. LARDNER. Enlarged and re-written by BENJAMIN LOEWY, F.R.A.S. 378 Illustrations. Post 8vo, cloth 6/0
 "The perspicuity of the original has been retained, and chapters which had become obsolete have been replaced by others of more modern character. The explanations throughout are studiously popular, and care has been taken to show the application of the various branches of physics to the industrial arts, and to the practical business of life."—*Mining Journal*.

HANDBOOK OF HYDROSTATICS AND PNEUMATICS.

By Dr. LARDNER. New Edition, Revised and Enlarged by BENJAMIN LOEWY, F.R.A.S. With 236 Illustrations. Post 8vo, cloth 5/0
 "For those 'who desire to attain an accurate knowledge of physical science without the profound methods of mathematical investigation,' this work is well adapted."—*Chemical News*.

HANDBOOK OF HEAT.

By Dr. LARDNER. Edited and re-written by BENJAMIN LOEWY, F.R.A.S., &c. 117 Illustrations. Post 8vo, cloth 6/0
 "The style is always clear and precise, and conveys instruction without leaving any cloudiness or lurking doubts behind."—*Engineering*.

HANDBOOK OF OPTICS.

By Dr. LARDNER. New Edition. Edited by T. OLVER HARDING, B.A. Lond. With 298 Illustrations. Small 8vo, 448 pp., cloth 5/0
 "Written by one of the ablest English scientific writers, beautifully and elaborately illustrated."—*Mechanics' Magazine*.

ELECTRICITY, MAGNETISM, AND ACOUSTICS.

By Dr. LARDNER. Edited by GEO. CAREY FOSTER, B.A., F.C.S. With 400 Illustrations. Small 8vo, cloth 5/0
 "The book could not have been entrusted to any one better calculated to preserve the terse and lucid style of Lardner, while correcting his errors and bringing up his work to the present state of scientific knowledge."—*Popular Science Review*.

HANDBOOK OF ASTRONOMY.

By Dr. LARDNER. Fourth Edition. Revised and Edited by EDWIN DUNKIN, F.R.A.S., Royal Observatory, Greenwich. With 38 Plates and upwards of 100 Woodcuts. 8vo, cloth 9/6
 "Probably no other book contains the same amount of information in so compendious and well arranged a form—certainly none at the price at which this is offered to the public."—*Athenaeum*.
 "We can do no other than pronounce this work a most valuable manual of astronomy, and we strongly recommend it to all who wish to acquire a general—but at the same time correct—acquaintance with this sublime science."—*Quarterly Journal of Science*.

MUSEUM OF SCIENCE AND ART.

Edited by Dr. LARDNER. With upwards of 1,200 Engravings on Wood. In Six Double Volumes, £1 1s. in a new and elegant cloth binding; or handsomely bound in half-morocco £1 11s. 6d.
 "A cheap and interesting publication, alike informing and attractive. The papers combine subjects of importance and great scientific knowledge, considerable inductive powers, and a popular style of treatment."—*Spectator*.

Separate books formed from the above.

- | | |
|---------------------------------|------------------------------------|
| Common Things Explained. 5s. | Steam and its Uses. 2s. cloth. |
| The Microscope. 2s. cloth. | Popular Astronomy. 4s. 6d. cloth. |
| Popular Geology. 2s. 6d. cloth. | The Bee and White Ants. 2s. cloth. |
| Popular Physics. 2s. 6d. cloth. | The Electric Telegraph. 1s. 6d. |

NATURAL PHILOSOPHY FOR SCHOOLS.

By Dr. LARDNER. Fcap. 8vo 3/6
 "A very convenient class book for junior students in private schools."—*British Quarterly Review*.

ANIMAL PHYSIOLOGY FOR SCHOOLS.

By Dr. LARDNER. Fcap. 8vo 3/6
 "Clearly written, well arranged, and excellently illustrated."—*Gardener's Chronicle*.

THE ELECTRIC TELEGRAPH.

By Dr. LARDNER. Revised by E. B. BRIGHT, F.R.A.S. Fcap. 8vo. 2/6
 "One of the most readable books extant on the Electric Telegraph."—*English Mechanic*.

CHEMICAL MANUFACTURES, CHEMISTRY, &c.

THE GAS ENGINEER'S POCKET-BOOK.

Comprising Tables, Notes and Memoranda relating to the Manufacture, Distribution and Use of Coal Gas and the Construction of Gas Works. By H. G. COXSON, A.M.Inst.C.E. Second Edition, Revised. 470 pp., crown 8vo, fully illustrated, leather. [Just Published. 10/6

"The book contains a vast amount of information. The author goes consecutively through the engineering details and technical methods involved in each of the different processes or parts of a gas works. He has certainly succeeded in making a compilation of hard matters of fact *strikingly interesting to read*."—*Gas Works*.

A volume of reference for the gas engineer and all interested in lighting or heating by gas, while the analysis of the various descriptions of gas will be of value to the technical chemist. All workers in any way connected with the manufacture and use of gas is dealt with. The book has evidently been carefully compiled, and certainly constitutes a useful addition to gas literature."—*Builder*.

"The volume contains a great quantity of specialised information, compiled, we believe, from trustworthy sources, which should make it of considerable value to those for whom it is specially *published*."—*Engineer*.

LIGHTING BY ACETYLENE

Generators, Burners, and Electric Furnaces. By WILLIAM E. GIBBS, M.E. With 66 Illustrations. Crown 8vo, cloth. [Just Published. 7/6

ENGINEERING CHEMISTRY.

A Practical Treatise for the Use of Analytical Chemists, Engineers, Iron Masters, Iron Founders, Students and others. Comprising Methods of Analysis and Valuation of the Principal Materials used in Engineering Work, with Analyses, Examples and Suggestions. By H. J. PHILLIPS, F.I.C., F.C.S. Third Edition, Revised and Enlarged. Crown 8vo, 420 pp., with Plates and other Illustrations, cloth. [Just Published. Net 10/6

"In this work the author has rendered no small service to a numerous body of practical men. . . . The analytical methods may be pronounced most satisfactory, being as accurate as the despatch required of engineering chemists permits."—*Chemical News*.

"Full of good things. As a handbook of technical analysis, it is very welcome."—*Builder*.

"The analytical methods given are, as a whole, such as are likely to give rapid and trustworthy results in experienced hands. . . . There is much excellent descriptive matter in the work, the chapter on 'Oils and Lubrication' being specially noticeable in this respect."—*Engineer*.

NITRO-EXPLOSIVES.

A Practical Treatise concerning the Properties, Manufacture, and Analysis of Nitrated Substances, including the Fulminates, Smokeless Powders, and Celluloid. By P. G. SANFORD, F.I.C., Consulting Chemist to the Cotton Powder Company, &c. With Illustrations. Crown 8vo, cloth. [Just Published. 9/0

"Any one having the requisite apparatus and materials could make nitro-glycerine or gun-cotton, to say nothing of other explosives, by the aid of the instructions in this volume. This is one of the very few text-books in which can be found just what is wanted. Mr. Sanford goes through the whole list of explosives commonly used, names any given explosive, and tells us of what it is composed and how it is manufactured. The book is excellent throughout."—*Engineer*.

A HANDBOOK ON MODERN EXPLOSIVES.

A Practical Treatise on the Manufacture and Use of Dynamite, Gun-Cotton, Nitro-Glycerine and other Explosive Compounds, including Collodion-Cotton. With Chapters on Explosives in Practical Application. By M. EISSLER, Mining Engineer and Metallurgical Chemist. Second Edition, Enlarged. With 150 Illustrations. Crown 8vo, cloth. [Just Published. 12/6

"Useful not only to the miner, but also to officers of both services to whom blasting and the use of explosives generally may at any time become a necessary auxiliary."—*Nature*.

DANGEROUS GOODS.

Their Sources and Properties, Modes of Storage and Transport. With Notes and Comments on Accidents arising therefrom, together with the Government and Railway Classifications, Acts of Parliament, &c. A Guide for the Use of Government and Railway Officials, Steamship Owners, Insurance Companies and Manufacturers, and Users of Explosives and Dangerous Goods. By H. JOSHUA PHILLIPS, F.I.C., F.C.S. Crown 8vo, 374 pp., cloth. 9/0
Merits a wide circulation, and an intelligent, appreciative study."—*Chemical News*

A MANUAL OF THE ALKALI TRADE.

Including the Manufacture of Sulphuric Acid, Sulphate of Soda, and Bleaching Powder. By JOHN LOMAS, Alkali Manufacturer, Newcastle-upon-Tyne and London. 390 pp. of Text. With 232 Illustrations and Working Drawings, Second Edition, with Additions. Super-royal 8vo, cloth . . . £1 10s.

"This book is written by a manufacturer for manufacturers. The working details of the most approved forms of apparatus are given, and these are accompanied by no less than 232 wood engravings, all of which may be used for the purposes of construction. Every step in the manufacture is very fully described in this manual, and each improvement explained."—*Athenæum*.

"We find not merely a sound and luminous explanation of the chemical principles of the trade, but a notice of numerous matters which have a most important bearing on the successful conduct of alkali works, but which are generally overlooked by even experienced technological authors."—*Chemical Review*.

THE BLOWPIPE IN CHEMISTRY, MINERALOGY, AND GEOLOGY.

Containing all known Methods of Anhydrous Analysis, many Working Examples, and Instructions for Making Apparatus. By Lieut.-Colonel W. A. ROSS, R.A., F.G.S. With 120 Illustrations. Second Edition, Enlarged. Crown 8vo, cloth 8/0

"The student who goes conscientiously through the course of experimentation here laid down will gain a better insight into inorganic chemistry and mineralogy than if he had 'got up' any of the best text-books of the day, and passed any number of examinations in their contents"—*Chemical News*.

THE MANUAL OF COLOURS AND DYE-WARES.

Their Properties, Applications, Valuations, Impurities and Sophistications For the Use of Dyers, Printers, Drysalters, Brokers, &c. By J. W. SLATER. Second Edition, Revised and greatly Enlarged. Crown 8vo, cloth . . . 7/6

"A complete encyclopædia of the *materia tinctoria*. The information given respecting each article is full and concise, and the methods of determining the value of articles such as these, so liable to sophistication, are given with clearness, and are practical as well as valuable."—*Chemist and Druggist*.

"There is no other work which covers precisely the same ground. To students preparing for examinations in dyeing and printing it will prove exceedingly useful."—*Chemical News*.

A HANDY BOOK FOR BREWERS.

Being a Practical Guide to the Art of Brewing and Malting. Embracing the Conclusions of Modern Research which bear upon the Practice of Brewing. By HERBERT EDWARDS WRIGHT, M.A. Second Edition, Enlarged. Crown 8vo, 530 pp., cloth. [Just Published. 12/6

"May be consulted with advantage by the student who is preparing himself for examination tests, while the scientific brewer will find in it a *résumé* of all the most important discoveries of modern times. The work is written throughout in a clear and concise manner, and the author takes great care to discriminate between vague theories and well-established facts."—*Brewers' Journal*.

"We have great pleasure in recommending this handy book, and have no hesitation in saying that it is one of the best—if not the best—which has yet been written on the subject of beer-brewing in this country; it should have a place on the shelves of every brewer's library."—*Brewers' Guardian*.

"Although the requirements of the student are primarily considered, an acquaintance of half-an-hour's duration cannot fail to impress the practical brewer with the sense of having found a trustworthy guide and practical counsellor in brewery matters."—*Chemical Trade Journal*.

FUELS: SOLID, LIQUID, AND GASEOUS.

Their Analysis and Valuation. For the Use of Chemists and Engineers. By H. J. PHILLIPS, F.C.S., formerly Analytical and Consulting Chemist to the G.E. Rlwy. Third Edition, Revised and Enlarged. Crown 8vo, cloth 2/0

"Ought to have its place in the laboratory of every metallurgical establishment and wherever fuel is used on a large scale."—*Chemical News*.

THE ARTISTS' MANUAL OF PIGMENTS.

Showing their Composition, Conditions of Permanency, Non-Permanency, and Adulterations; Effects in Combination with Each Other and with Vehicles; and the most Reliable Tests of Purity. By H. C. STANDAGE. Crown 8vo. 2/6

"This work is indeed *multum-in-parvo*, and we can, with good conscience, recommend it to all who come in contact with pigments, whether as makers, dealers, or users."—*Chemical Review*.

A POCKET-BOOK OF MENSURATION AND GAUGING.

Containing Tables, Rules, and Memoranda for Revenue Officers, Brewers, Spirit Merchants, &c. By J. B. MANT, Inland Revenue. Second Edition, Revised. 18mo, leather 4/0

"This handy and useful book is adapted to the requirements of the Inland Revenue Department, and will be a favourite book of reference."—*Civilian*.
 "Should be in the hands of every practical brewer."—*Brewers' Journal*.

INDUSTRIAL ARTS, TRADES, AND MANUFACTURES.**TEA MACHINERY AND TEA FACTORIES.**

A Descriptive Treatise on the Mechanical Appliances required in the Cultivation of the Tea Plant and the Preparation of Tea for the Market. By A. J. WALLIS-TAYLER, A. M. Inst. C.E. Medium 8vo, 468 pp. With 218 Illustrations. [Just Published. Net 25/0

SUMMARY OF CONTENTS:—MECHANICAL CULTIVATION OR TILLAGE OF THE SOIL.—PLUCKING OR GATHERING THE LEAF.—TEA FACTORIES.—THE DRESSING, MANUFACTURE, OR PREPARATION OF TEA BY MECHANICAL MEANS.—ARTIFICIAL WITHERING OF THE LEAF.—MACHINES FOR ROLLING OR CURLING THE LEAF.—FERMENTING PROCESS.—MACHINES FOR THE AUTOMATIC DRYING OR FIRING OF THE LEAF.—MACHINES FOR NON-AUTOMATIC DRYING OR FIRING OF THE LEAF.—DRYING OR FIRING MACHINES.—BREAKING OR CUTTING, AND SORTING MACHINES.—PACKING THE TEA.—MEANS OF TRANSPORT ON TEA PLANTATIONS.—MISCELLANEOUS MACHINERY AND APPARATUS.—FINAL TREATMENT OF THE TEA.—TABLES AND MEMORANDA.

"The subject of tea machinery is now one of the first interest to a large class of people, to whom we strongly commend the volume."—*Chamber of Commerce Journal*.

"When tea planting was first introduced into the British possessions little, if any, machinery was employed, but now its use is almost universal. This volume contains a very full account of the machinery necessary for the proper outfit of a factory, and also a description of the processes best carried out by this machinery."—*Journal Society of Arts*.

FLOUR MANUFACTURE.

A Treatise on Milling Science and Practice. By FRIEDRICH KICK, Imperial Regierungsrath, Professor of Mechanical Technology in the Imperial German Polytechnic Institute, Prague. Translated from the Second Enlarged and Revised Edition with Supplement. By H. H. P. POWLES, Assoc. Memb. Institution of Civil Engineers. Nearly 400 pp. Illustrated with 28 Folding Plates, and 167 Woodcuts. Royal 8vo, cloth £1 5s.

"This valuable work is, and will remain, the standard authority on the science of milling. . . . The miller who has read and digested this work will have laid the foundation, so to speak, of a successful career; he will have acquired a number of general principles which he can proceed to apply. In this handsome volume we at last have the accepted text-book of modern milling in good, sound English, which has little, if any, trace of the German idiom."—*The Miller*.

COTTON MANUFACTURE.

A Manual of Practical Instruction of the Processes of Opening, Carding, Combing, Drawing, Doubling and Spinning of Cotton, the Methods of Dyeing, &c. For the Use of Operatives Overlookers, and Manufacturers. By JOHN LISTER, Technical Instructor, Pendleton. 8vo, cloth 7/6

"A distinct advance in the literature of cotton manufacture."—*Machinery*.

"It is thoroughly reliable, fulfilling nearly all the requirements desired."—*Glasgow Herald*.

MODERN CYCLES.

A Practical Handbook on their Construction and Repair. By A. J. WALLIS-TAYLER, A. M. Inst. C.E., Author of "Refrigerating Machinery," &c. With upwards of 300 Illustrations. Crown 8vo, cloth. [Just Published. 10/6

"The large trade that is done in the component parts of bicycles has placed in the way of men mechanically inclined extraordinary facilities for building bicycles for their own use. . . . The book will prove a valuable guide for all those who aspire to the manufacture or repair of their own machines."—*The Field*.

"A most comprehensive and up-to-date treatise."—*The Cycle*.

"A very useful book, which is quite entitled to rank as a standard work for students of cycle construction."—*Wheeling*.

CEMENTS, PASTES, GLUES, AND GUMS.

A Practical Guide to the Manufacture and Application of the various Agglutinants required in the Building, Metal-Working, Wood-Working, and Leather-Working Trades, and for Workshop, Laboratory or Office Use. With upwards of 900 Recipes and Formulæ. By H. C. STANDAGE, Chemist. Third Edition. Crown 8vo, cloth. [Just Published. 2/6

"We have pleasure in speaking favourably of this volume. So far as we have had experience, which is not inconsiderable, this manual is trustworthy."—*Athenæum*.

"As a revelation of what are considered trade secrets, this book will arouse an amount of curiosity among the large number of industries it touches."—*Daily Chronicle*.

THE ART OF SOAP-MAKING.

A Practical Handbook of the Manufacture of Hard and Soft Soaps, Toilet Soaps, &c. Including many New Processes, and a Chapter on the Recovery of Glycerine from Waste Leys. By ALX. WATT. Sixth Edition, including an Appendix on Modern Candlemaking. Crown 8vo, cloth. [Just Published. 7/6

"The work will prove very useful, not merely to the technological student, but to the practical soap boiler who wishes to understand the theory of his art."—*Chemical News*.

"A thoroughly practical treatise on an art which has almost no literature in our language. We congratulate the author on the success of his endeavour to fill a void in English technical literature."—*Nature*.

PRACTICAL PAPER-MAKING.

A Manual for Paper-Makers and Owners and Managers of Paper-Mills. With Tables, Calculations, &c. By G. CLAPPERTON, Paper-Maker. With Illustrations of Fibres from Micro-Photographs. Crown 8vo, cloth . . . 5/0

"The author caters for the requirements of responsible mill hands, apprentices, &c., whilst his manual will be found of great service to students of technology, as well as to veteran paper-makers and mill owners. The illustrations form an excellent feature."—*The World's Paper Trade Review*.

"We recommend everybody interested in the trade to get a copy of this thoroughly practical book."—*Paper Making*.

THE ART OF PAPER-MAKING.

A Practical Handbook of the Manufacture of Paper from Rags, Esparto, Straw, and other Fibrous Materials. Including the Manufacture of Pulp from Wood Fibre, with a Description of the Machinery and Appliances used. To which are added Details of Processes for Recovering Soda from Waste Liquors. By ALEXANDER WATT, Author of "The Art of Soap-Making." With Illustrations. Crown 8vo, cloth . . . 7/6

It may be regarded as the standard work on the subject. The book is full of valuable information. The "Art of Paper-Making" is in every respect a model of a text-book, either for a technical class, or for the private student. —*Paper and Printing Trades Journal*.

A TREATISE ON PAPER.

For Printers and Stationers. With an Outline of Paper Manufacture; Complete Tables of Sizes, and Specimens of Different Kinds of Paper. By RICHARD PARKINSON, late of the Manchester Technical School. Demy 8vo, cloth. [Just Published. 3/6

THE ART OF LEATHER MANUFACTURE.

Being a Practical Handbook, in which the Operations of Tanning, Currying, and Leather Dressing are fully Described, and the Principles of Tanning Explained, and many Recent Processes Introduced; as also Methods for the Estimation of Tannin, and a Description of the Arts of Glue Boiling, Gut Dressing, &c. By ALEXANDER WATT, Author of "Soap-Making," &c. Fourth Edition. Crown 8vo, cloth . . . 9/0

"A sound, comprehensive treatise on tanning and its accessories. The book is an eminently valuable production, which redounds to the credit of both author and publishers."—*Chemical Review*.

THE ART OF BOOT AND SHOE MAKING.

A Practical Handbook, including Measurement, Last-Fitting, Cutting-Out, Closing and Making, with a Description of the most approved Machinery Employed. By JOHN B. LENO, late Editor of *St. Crispin*, and *The Boot and Shoe-Maker*. 12mo, cloth . . . 2/0

WOOD ENGRAVING.

A Practical and Easy Introduction to the Study of the Art. By W. N. BROWN. 12mo, cloth 1/6

"The book is clear and complete, and will be useful to any one wanting to understand the first elements of the beautiful art of wood engraving."—*Graphic*.

MODERN HOROLOGY, IN THEORY AND PRACTICE.

Translated from the French of CLAUDIUS SAUNIER, ex-Director of the School of Horology at Macon, by JULIEN TRIPPLIN, F.R.A.S., Besancon Watch Manufacturer, and EDWARD RIGG, M.A., Assayer in the Royal Mint. With Seventy-eight Woodcuts and Twenty-two Coloured Copper Plates. Second Edition. Super-royal 8vo, cloth, £2 2s.; half-calf £2 10s.

"There is no horological work in the English language at all to be compared to this production of M. Saunier's for clearness and completeness. It is alike good as a guide for the student and as a reference for the experienced horologist and skilled workman."—*Horological Journal*.

"The latest, the most complete, and the most reliable of those literary productions to which continental watchmakers are indebted for the mechanical superiority over their English brethren—in fact, the Book of Books, is M. Saunier's 'Treatise.'"—*Watchmaker, Jeweller, and Silversmith*.

THE WATCH ADJUSTER'S MANUAL.

A Practical Guide for the Watch and Chronometer Adjuster in Making, Springing, Timing and Adjusting for Isochronism, Positions and Temperatures. By C. E. FRITTS. 370 pp., with Illustrations, 8vo, cloth 16/0

THE WATCHMAKER'S HANDBOOK.

Intended as a Workshop Companion for those engaged in Watchmaking and the Allied Mechanical Arts. Translated from the French of CLAUDIUS SAUNIER, and enlarged by JULIEN TRIPPLIN, F.R.A.S., and EDWARD RIGG, M.A., Assayer in the Royal Mint. Third Edition. 8vo, cloth. 9/0

"Each part is truly a treatise in itself. The arrangement is good and the language is clear and concise. It is an admirable guide for the young watchmaker."—*Engineering*.

"It is impossible to speak too highly of its excellence. It fulfils every requirement in a handbook intended for the use of a workman. Should be found in every workshop."—*Watch and Clockmaker*.

A HISTORY OF WATCHES & OTHER TIMEKEEPERS.

By JAMES F. KENDAL, M.B.H. Inst. Boards, 1/6; or cloth, gilt 2/6

"The best which has yet appeared on this subject in the English language."—*Industries*.

"Open the book where you may, there is interesting matter in it concerning the ingenious devices of the ancient or modern horologist."—*Saturday Review*.

ELECTRO-PLATING & ELECTRO-REFINING OF METALS.

Being a new edition of ALEXANDER WATT'S "ELECTRO-DEPOSITION." Revised and Largely Rewritten by ARNOLD PHILIP, B.Sc., A.I.E.E., Principal Assistant to the Admiralty Chemist. Large Crown 8vo, cloth.

[Just Published. Net. 12/6

"Eminently a book for the practical worker in electro-deposition. It contains practical descriptions of methods, processes and materials, as actually pursued and used in the workshop."—*Engineer*.

ELECTRO-METALLURGY.

Practically Treated. By ALEXANDER WATT. Tenth Edition, including the most recent Processes. 12mo, cloth 3/6

"From this book both amateur and artisan may learn everything necessary for the successful prosecution of electroplating."—*Iron*.

JEWELLER'S ASSISTANT IN WORKING IN GOLD.

A Practical Treatise for Masters and Workmen, Compiled from the Experience of Thirty Years' Workshop Practice. By GEORGE E. GEE, Author of "The Goldsmith's Handbook," &c. Crown 8vo, cloth 7/6

"This manual of technical education is apparently destined to be a valuable auxiliary to a handicraft which is certainly capable of great improvement."—*The Times*.

ELECTROPLATING.

A Practical Handbook on the Deposition of Copper, Silver, Nickel, Gold, Aluminium, Brass, Platinum, &c., &c. By J. W. URQUHART, C.E. Fourth Edition, Revised. Crown 8vo, cloth. *[Just Published.]* 5/0

"An excellent practical manual."—*Engineering.*

"An excellent work, giving the newest information."—*Horological Journal.*

ELECTROTYPING.

The Reproduction and Multiplication of Printing Surfaces and Works of Art by the Electro-Deposition of Metals. By J. W. URQUHART, C.E. Crown 8vo, cloth. 5/0

"The book is thoroughly practical; the reader is, therefore, conducted through the leading laws of electricity, then through the metals used by electrotypers, the apparatus, and the depositing processes, up to the final preparation of the work."—*Art Journal.*

GOLDSMITH'S HANDBOOK.

By GEORGE E. GEE, Jeweller, &c. Fifth Edition. 12mo, cloth. 3/0

"A good, sound educator, and will be generally accepted as an authority."—*Horological Journal.*

SILVERSMITH'S HANDBOOK.

By GEORGE E. GEE, Jeweller, &c. Third Edition, with numerous Illustrations. 12mo, cloth. 3/0

"The chief merit of the work is its practical character. . . . The workers in the trade will speedily discover its merits when they sit down to study it."—*English Mechanic.*

* * * *The above two works together, strongly half-bound, price 7s.*

SHEET METAL WORKER'S INSTRUCTOR.

Comprising a Selection of Geometrical Problems and Practical Rules for Describing the Various Patterns Required by Zinc, Sheet-Iron, Copper, and Tin-Plate Workers. By REUBEN HENRY WARN. New Edition, Revised and greatly Enlarged by JOSEPH G. HORNER, A.M.I.M.E. Crown 8vo, 254 pp., with 430 Illustrations, cloth. *[Just Published.]* 7/6

BREAD & BISCUIT BAKER'S & SUGAR-BOILER'S ASSISTANT.

Including a large variety of Modern Recipes. With Remarks on the Art of Bread-making. By ROBERT WELLS. Third Edition. Crown 8vo, cloth. 2/0

"A large number of wrinkles for the ordinary cook, as well as the baker."—*Saturday Review.*

PASTRYCOOK & CONFECTIONER'S GUIDE.

For Hotels, Restaurants, and the Trade in general, adapted also for Family Use. By R. WELLS, Author of "The Bread and Biscuit Baker." Crown 8vo, cloth. 2/0

"We cannot speak too highly of this really excellent work. In these days of keen competition our readers cannot do better than purchase this book."—*Bakers' Times.*

ORNAMENTAL CONFECTIONERY.

A Guide for Bakers, Confectioners and Pastrycooks; including a variety of Modern Recipes, and Remarks on Decorative and Coloured Work. With 120 Original Designs. By ROBERT WELLS. Second Edition. Crown 8vo. 5/0

"A valuable work, practical, and should be in the hands of every baker and confectioner. The illustrative designs are alone worth treble the amount charged for the whole work."—*Bakers' Times.*

THE MODERN FLOUR CONFECTIONER, WHOLESALE AND RETAIL.

Containing a large Collection of Recipes for Cheap Cakes, Biscuits, &c. With remarks on the Ingredients Used in their Manufacture. By ROBERT WELLS, Author of "The Bread and Biscuit Baker," &c. Crown 8vo, cloth. 2/0

"The work is of a decidedly practical character, and in every recipe regard is had to economical working."—*North British Daily Mail.*

RUBBER HAND STAMPS

And the Manipulation of Rubber. A Practical Treatise on the Manufacture of Indiarubber Hand Stamps, Small Articles of Indiarubber, The Hektograph, Special Inks, Cements, and Allied Subjects. By T. O'CONNOR SLOANE, A.M., Ph.D. With numerous Illustrations. Square 8vo, cloth. 5/0

HANDYBOOKS FOR HANDICRAFTS.

BY PAUL N. HASLACK.

Editor of "Work" (New Series), Author of "Lathe Work," "Milling Machines," &c. Crown 8vo, 144 pp., price 1s. each.

These HANDYBOOKS have been written to supply information for WORKMEN, STUDENTS, and AMATEURS in the several Handicrafts, on the actual PRACTICE of the WORKSHOP, and are intended to convey in plain language TECHNICAL KNOWLEDGE of the several CRAFTS. In describing the processes employed, and the manipulation of material, workshop terms are used; workshop practice is fully explained; and the text is freely illustrated with drawings of modern tools, appliances, and processes.

THE METAL TURNER'S HANDYBOOK.

A Practical Manual for Workers at the Foot-Lathe. With over 100 Illustrations. 1/0

"The book will be of service alike to the amateur and the artisan turner. It displays thorough knowledge of the subject."—*Scottsman*.

THE WOOD TURNER'S HANDYBOOK.

A Practical Manual for Workers at the Lathe. With over 100 Illustrations. 1/0

"We recommend the book to young turners and amateurs. A multitude of workmen have hitherto sought in vain for a manual of this special industry."—*Mechanical World*.

THE WATCH JOBBER'S HANDYBOOK.

A Practical Manual on Cleaning, Repairing, and Adjusting. With upwards of 100 Illustrations. 1/0

"We strongly advise all young persons connected with the watch trade to acquire and study this inexpensive work."—*Clerkenwell Chronicle*.

THE PATTERN MAKER'S HANDYBOOK.

A Practical Manual on the Construction of Patterns for Founders. With upwards of 100 Illustrations. 1/0

"A most valuable, if not indispensable manual for the pattern maker."—*Knowledge*.

THE MECHANIC'S WORKSHOP HANDYBOOK.

A Practical Manual on Mechanical Manipulation, embracing Information on various Handicraft Processes. With Useful Notes and Miscellaneous Memoranda. Comprising about 200 Subjects. 1/0

"A very clever and useful book, which should be found in every workshop; and it should certainly find a place in all technical schools."—*Saturday Review*.

THE MODEL ENGINEER'S HANDYBOOK.

A Practical Manual on the Construction of Model Steam Engines. With upwards of 100 Illustrations. 1/0

"Mr. Hasluck has produced a very good little book."—*Builder*.

THE CLOCK JOBBER'S HANDYBOOK.

A Practical Manual on Cleaning, Repairing, and Adjusting. With upwards of 100 Illustrations. 1/0

"It is of inestimable service to those commencing the trade."—*Coventry Standard*.

THE CABINET MAKER'S HANDYBOOK.

A Practical Manual on the Tools, Materials, Appliances, and Processes employed in Cabinet Work. With upwards of 100 Illustrations. 1/0

"Mr. Hasluck's thorough-going little Handybook is amongst the most practical guides we have seen for beginners in cabinet-work."—*Saturday Review*.

THE WOODWORKER'S HANDYBOOK OF MANUAL INSTRUCTION.

Embracing Information on the Tools, Materials, Appliances and Processes Employed in Woodworking. With 104 Illustrations. 1/0

OPINIONS OF THE PRESS.

"Written by a man who knows, not only how work ought to be done, but how to do it, and how to convey his knowledge to others."—*Engineering*.

"Mr. Hasluck writes admirably, and gives complete instructions."—*Engineer*.

"Mr. Hasluck combines the experience of a practical teacher with the manipulative skill and scientific knowledge of processes of the trained mechanic, and the manuals are marvels of what can be produced at a popular price."—*Schoolmaster*.

"Helpful to workmen of all ages and degrees of experience."—*Daily Chronicle*.

"Practical, sensible, and remarkably cheap."—*Journal of Education*.

"Concise, clear, and practical."—*Saturday Review*.

COMMERCE, COUNTING-HOUSE WORK, TABLES, &c.

LESSONS IN COMMERCE.

By Professor R. GAMBARO, of the Royal High Commercial School at Genoa. Edited and Revised by JAMES GAULT, Professor of Commerce and Commercial Law in King's College, London. Fourth Edition. Crown 8vo, cloth . 3/6

"The publishers of this work have rendered considerable service to the cause of commercial education by the opportune production of this volume. . . . The work is peculiarly acceptable to English readers and an admirable addition to existing class books. In a phrase, we think the work attains its object in furnishing a brief account of those laws and customs of British trade with which the commercial man interested therein should be familiar."—*Chamber of Commerce Journal*.

"An invaluable guide in the hands of those who are preparing for a commercial career, and, in fact, the information it contains on matters of business should be impressed on every one."—*Counting House*.

THE FOREIGN COMMERCIAL CORRESPONDENT.

Being Aids to Commercial Correspondence in Five Languages—English, French, German, Italian, and Spanish. By CONRAD E. BAKER. Third Edition, Carefully Revised Throughout. Crown 8vo, cloth.

[Just Published. 4/6

"Whoever wishes to correspond in all the languages mentioned by Mr. Baker cannot do better than study this work, the materials of which are excellent and conveniently arranged. They consist not of entire specimen letters, but—what are far more useful—short passages, sentences, or phrases expressing the same general idea in various forms."—*Athenaeum*.

"A careful examination has convinced us that it is unusually complete, well arranged and reliable. The book is a thoroughly good one."—*Schoolmaster*.

FACTORY ACCOUNTS: their PRINCIPLES & PRACTICE.

A Handbook for Accountants and Manufacturers, with Appendices on the Nomenclature of Machine Details; the Income Tax Acts; the Rating of Factories; Fire and Boiler Insurance; the Factory and Workshop Acts, &c., including also a Glossary of Terms and a large number of Specimen Rulings. By EMILE GARCKE and J. M. FÉLLS. Fifth Edition, Revised and Enlarged. Demy 8vo, cloth. [Just Published. 7/6

"A very interesting description of the requirements of Factory Accounts. . . . The principle of assimilating the Factory Accounts to the general commercial books is one which we thoroughly agree with."—*Accountants' Journal*.

"Characterised by extreme thoroughness. There are few owners of factories who would not derive great benefit from the perusal of this most admirable work."—*Local Government Chronicle*.

MODERN METROLOGY.

A Manual of the Metrical Units and Systems of the present Century. With an Appendix containing a proposed English System. By LOWIS D. A. JACKSON, A. M. Inst. C. E., Author of "Aid to Survey Practice," &c. Large crown 8vo, cloth 12/6

"We recommend the work to all interested in the practical reform of our weights and measures."—*Nature*.

A SERIES OF METRIC TABLES.

In which the British Standard Measures and Weights are compared with those of the Metric System at present in Use on the Continent. By C. H. DOWLING, C.E. 8vo, strongly bound 10/6

"Mr. Dowling's Tables are well put together as a ready reckoner for the conversion of one system into the other."—*Athenaeum*.

THE IRON AND METAL TRADES' COMPANION.

For Expeditioniously Ascertaining the Value of any Goods bought or sold by Weight, from 1s. per cwt. to 112s. per cwt., and from one farthing per pound to one shilling per pound. By THOMAS DOWNIE. 396 pp., leather . . 9/0

"A most useful set of tables, nothing like them before existed."—*Building News*.

"Although specially adapted to the iron and metal trades, the tables will be found useful in every other business in which merchandise is bought and sold by weight."—*Railway News*.

NUMBER, WEIGHT, AND FRACTIONAL CALCULATOR.

Containing upwards of 250,000 Separate Calculations, showing at a Glance the Value at 422 Different Rates, ranging from $\frac{1}{16}$ th of a Penny to 20s. each, or per cwt., and £20 per ton, of any number of articles consecutively, from 1 to 470. Any number of cwts., qrs., and lbs., from 1 cwt. to 470 cwts. Any number of tons, cwts., qrs., and lbs., from 1 to 1,000 tons. By WILLIAM CHADWICK, Public Accountant. Third Edition, Revised. 8vo, strongly bound . . . **18/0**

"It is as easy of reference for any answer or any number of answers as a dictionary. For making up accounts or estimates the book must prove invaluable to all who have any considerable quantity of calculations involving price and measure in any combination to do."—*Engineer*.

"The most perfect work of the kind yet prepared."—*Glasgow Herald*.

THE WEIGHT CALCULATOR.

Being a Series of Tables upon a New and Comprehensive Plan, exhibiting at one Reference the exact Value of any Weight from 1 lb. to 15 tons, at 300 Progressive Rates, from 1d. to 168s. per cwt., and containing 186,000 Direct Answers, which, with their Combinations, consisting of a single addition (mostly to be performed at sight), will afford an aggregate of 10,266,000 Answers; the whole being calculated and designed to ensure correctness and promote despatch. By HENRY HARBEN, Accountant. Fifth Edition, carefully Corrected. Royal 8vo, strongly half-bound . . . **£1 5s.**

"A practical and useful work of reference for men of business generally."—*Ironmonger*.

"Of priceless value to business men. It is a necessary book in all mercantile offices."—*Sheffield Independent*.

THE DISCOUNT GUIDE.

Comprising several Series of Tables for the Use of Merchants, Manufacturers, Ironmongers, and Others, by which may be ascertained the Exact Profit arising from any mode of using Discounts, either in the Purchase or Sale of Goods, and the method of either Altering a Rate of Discount, or Advancing a Price, so as to produce, by one operation, a sum that will realise any required Profit after allowing one or more Discounts: to which are added Tables of Profit or Advance from $\frac{1}{2}$ to 90 per cent., Tables of Discount from $\frac{1}{2}$ to 98 $\frac{1}{2}$ per cent., and Tables of Commission, &c., from $\frac{1}{2}$ to 10 per cent. By HENRY HARBEN, Accountant. New Edition, Corrected. Demy 8vo, half-bound . . . **£1 5s.**

"A book such as this can only be appreciated by business men, to whom the saving of time means saving of money. The work must prove of great value to merchants, manufacturers, and general traders."—*British Trade Journal*.

TABLES OF WAGES.

At 54, 52, 50 and 48 Hours per Week. Showing the Amounts of Wages from One quarter of an hour to Sixty-four hours, in each case at Rates of Wages advancing by One Shilling from 4s. to 55s. per week. By THOS. GARBUTT, Accountant. Square crown 8vo, half-bound . . . **6/0**

IRON-PLATE WEIGHT TABLES.

For Iron Shipbuilders, Engineers, and Iron Merchants. Containing the Calculated Weights of upwards of 150,000 different sizes of Iron Plates from 1 foot by 6 in. by $\frac{1}{2}$ in. to 10 feet by 5 feet by 1 in. Worked out on the Basis of 40 lbs. to the square foot of Iron of 1 inch in thickness. By H. BURLINSON and W. H. SIMPSON. 4to, half-bound . . . **£1 5s.**

MATHEMATICAL TABLES (ACTUARIAL).

Comprising Commutation and Conversion Tables, Logarithms, Cologarithms, Antilogarithms and Reciprocals. By J. W. GORDON. Royal 8vo, mounted [Just Published] **5/0**

AGRICULTURE, FARMING, GARDENING, &c.

THE COMPLETE GRAZIER AND FARMER'S AND CATTLE BREEDER'S ASSISTANT.

A Compendium of Husbandry. Originally Written by WILLIAM YOUATT. Fourteenth Edition, entirely Re-written, considerably Enlarged, and brought up to Present Requirements, by WILLIAM FREAM, LL.D., Assistant Commissioner, Royal Commission on Agriculture, 1893, Author of "The Elements of Agriculture," &c. Royal 8vo, 1,100 pp., with over 450 Illustrations, handsomely bound. [Just Published. £1 11s. 6d.]

SUMMARY OF CONTENTS.

BOOK I. ON THE VARIETIES, BREEDING, REARING, FATTENING AND MANAGEMENT OF CATTLE.

BOOK II. ON THE ECONOMY AND MANAGEMENT OF THE DAIRY.

BOOK III. ON THE BREEDING, REARING, AND MANAGEMENT OF HORSES.

BOOK IV. ON THE BREEDING, REARING, AND FATTENING OF SHEEP.

BOOK V. ON THE BREEDING, REARING, AND FATTENING OF SWINE.

BOOK VI. ON THE DISEASES OF LIVE STOCK.

BOOK VII. ON THE BREEDING, REARING, AND MANAGEMENT OF POULTRY.

BOOK VIII. ON FARM OFFICES AND IMPLEMENTS OF HUSBANDRY.

BOOK IX. ON THE CULTURE AND MANAGEMENT OF GRASS LANDS.

BOOK X. ON THE CULTIVATION AND APPLICATION OF GRASSES, PULSE AND ROOTS.

BOOK XI. ON MANURES AND THEIR APPLICATION TO GRASS LAND AND CROPS.

BOOK XII. MONTHLY CALENDARS OF FARMWORK.

** OPINIONS OF THE PRESS ON THE NEW EDITION.

"Dr. Fream is to be congratulated on the successful attempt he has made to give us a work which will at once become the standard classic of the farm practice of the country. We believe that it will be found that it has no compeer among the many works at present in existence. The illustrations are admirable, while the frontispiece, which represents the well-known bull, New Year's Gift, owned by the Queen, is a work of art."—*The Times*.

"The book must be recognised as occupying the proud position of the most exhaustive work of reference in the English language on the subject with which it deals."—*Athenaeum*.

"The most comprehensive guide to modern farm practice that exists in the English language to-day. . . . The book is one that ought to be on every farm and in the library of every land owner."—*Mark Lane Express*.

"In point of exhaustiveness and accuracy the work will certainly hold a pre-eminent and unique position among books dealing with scientific agricultural practice. It is, in fact, an agricultural library of itself."—*North British Agriculturist*.

FARM LIVE STOCK OF GREAT BRITAIN.

By ROBERT WALLACE, F.L.S., F.R.S.E., &c., Professor of Agriculture and Rural Economy in the University of Edinburgh. Third Edition, thoroughly Revised and considerably Enlarged. With over 120 Phototypes of Prize Stock. Demy 8vo, 384 pp., with 79 Plates and Maps, cloth. 12/6

"A really complete work on the history, breeds, and management of the farm stock of Great Britain, and one which is likely to find its way to the shelves of every country gentleman's library."—*The Times*.

"The latest edition of 'Farm Live Stock of Great Britain' is a production to be proud of, and its issue not the least of the services which its author has rendered to agricultural science."—*Scottish Farmer*.

NOTE-BOOK OF AGRICULTURAL FACTS & FIGURES FOR FARMERS AND FARM STUDENTS.

By PRIMROSE MCCONNELL, B.Sc., Fellow of the Highland and Agricultural Society, Author of "Elements of Farming." Sixth Edition, Re-written, Revised, and greatly Enlarged. Fcap. 8vo, 480 pp., leather. [Just Published. 6/0]

SUMMARY OF CONTENTS: SURVEYING AND LEVELLING.—WEIGHTS AND MEASURES.—MACHINERY AND BUILDINGS.—LABOUR.—OPERATIONS.—DRAINING.—EMBANKING.—GEOLOGICAL MEMORANDA.—SOILS.—MANURES.—CROPPING.—CROPS.—ROTATIONS.—WEEDS.—FEEDING.—DAIRYING.—LIVE STOCK.—HORSES.—CATTLE.—SHEEP.—PIGS.—POULTRY.—FORESTRY.—HORTICULTURE.—MISCELLANEOUS.

"No farmer, and certainly no agricultural student, ought to be without this *multum-in-parvo* manual of all subjects connected with the farm."—*North British Agriculturist*.

"The amount of information it contains is most surprising; the arrangement of the matter is so methodical—although so compressed—as to be intelligible to everyone who takes a glance through its pages. They teem with information."—*Farm and Home*.

THE ELEMENTS OF AGRICULTURAL GEOLOGY.

A Scientific Aid to Practical Farming. By PRIMROSE MCCONNELL, Author of "Note-Book of Agricultural Facts and Figures." Royal 8vo, cloth. [Just Published. Net 21/0]

"On every page the work bears the impress of a masterly knowledge of the subject dealt with, and we have nothing but unreserved praise to offer."—*The Field*.

BRITISH DAIRYING.

A Handy Volume on the Work of the Dairy-Farm. For the Use of Technical Instruction Classes, Students in Agricultural Colleges and the Working Dairy-Farmer. By Prof. J. P. SHELTON. With Illustrations. Second Edition, Revised. Crown 8vo, cloth. [Just Published. 2/6

"Confidently recommended as a useful text-book on dairy farming."—*Agricultural Gazette*.
 "Probably the best half-crown manual on dairy work that has yet been produced."—*North British Agriculturist*.

"It is the soundest little work we have yet seen on the subject."—*The Times*.

MILK, CHEESE, AND BUTTER.

A Practical Handbook on their Properties and the Processes of their Production. Including a Chapter on Cream and the Methods of its Separation from Milk. By JOHN OLIVER, late Principal of the Western Dairy Institute, Berkeley. With Coloured Plates and 200 Illustrations. Crown 8vo, cloth. 7/6

"An exhaustive and masterly production. It may be cordially recommended to all students and practitioners of dairy science."—*North British Agriculturist*.

"We recommend this very comprehensive and carefully-written book to dairy-farmers and students of dairying. It is a distinct acquisition to the library of the agriculturist."—*Agricultural Gazette*.

SYSTEMATIC SMALL FARMING.

Or, The Lessons of My Farm. Being an Introduction to Modern Farm Practice for Small Farmers. By R. SCOTT BURN, Author of "Outlines of Modern Farming," &c. Crown 8vo, cloth. 6/0

"This is the completest book of its class we have seen, and one which every amateur farmer will read with pleasure, and accept as a guide."—*Field*.

OUTLINES OF MODERN FARMING.

By R. SCOTT BURN. Soils, Manures, and Crops—Farming and Farming Economy—Cattle, Sheep, and Horses—Management of Dairy, Pigs, and Poultry—Utilisation of Town-Sewage, Irrigation, &c. Sixth Edition. In One Vol., 1,250 pp., half-bound, profusely illustrated. 12/0

FARM ENGINEERING, The COMPLETE TEXT-BOOK of.

Comprising Draining and Embanking; Irrigation and Water Supply; Farm Roads, Fences and Gates; Farm Buildings; Barn Implements and Machines; Field Implements and Machines; Agricultural Surveying, &c. By Professor JOHN SCOTT. In One Vol., 1,250 pp., half-bound, with over 600 Illustrations. 12/0

"Written with great care, as well as with knowledge and ability. The author has done his work well; we have found him a very trustworthy guide wherever we have tested his statements. The volume will be of great value to agricultural students."—*Mark Lane Express*.

THE FIELDS OF GREAT BRITAIN.

A Text-Book of Agriculture. Adapted to the Syllabus of the Science and Art Department. For Elementary and Advanced Students. By HUGH CLEMENTS (Board of Trade). Second Edition, Revised, with Additions. 18mo, cloth. 2/6

"It is a long time since we have seen a book which has pleased us more, or which contains such a vast and useful fund of knowledge."—*Educational Times*.

TABLES and MEMORANDA for FARMERS, GRAZIERS, AGRICULTURAL STUDENTS, SURVEYORS, LAND AGENTS, AUCTIONEERS, &c.

With a New System of Farm Book-keeping. By SIDNEY FRANCIS. Fifth Edition. 272 pp., waistcoat-pocket size, limp leather. 1/6

"Weighing less than 1 oz., and occupying no more space than a match-box, it contains a mass of facts and calculations which has never before, in such handy form, been obtainable. Every operation on the farm is dealt with. The work may be taken as thoroughly accurate, the whole of the tables having been revised by Dr. Freame. We cordially recommend it."—*Bell's Weekly Messenger*.

THE ROTHAMSTED EXPERIMENTS AND THEIR PRACTICAL LESSONS FOR FARMERS.

Part I. STOCK. Part II. CROPS. By C. J. R. TIPPER. Crown 8vo, cloth. [Just Published. 3/6

"We have no doubt that the book will be welcomed by a large class of farmers and others interested in agriculture."—*Standard*.

FERTILISERS AND FEEDING STUFFS.

A Handbook for the Practical Farmer. By BERNARD DYER, D.Sc. (Lond.). With the Text of the Fertilisers and Feeding Stuffs Act of 1893, &c. Third Edition, Revised. Crown 8vo, cloth. *[Just Published.]* 1/0
 "This little book is precisely what it professes to be—'A Handbook for the Practical Farmer.' Dr. Dyer has done farmers good service in placing at their disposal so much useful information in so intelligible a form."—*The Times*.

BEEES FOR PLEASURE AND PROFIT.

A Guide to the Manipulation of Bees, the Production of Honey, and the General Management of the Apiary. By G. GORDON SAMSON. With numerous Illustrations. Crown 8vo, wrapper 1/0

BOOK-KEEPING for FARMERS and ESTATE OWNERS.

A Practical Treatise, presenting, in Three Plans, a System adapted for all Classes of Farms. By JOHNSON M. WOODMAN, Chartered Accountant. Fourth Edition. Crown 8vo, cloth 2/6
 "The volume is a capital study of a most important subject."—*Agricultural Gazette*.

WOODMAN'S YEARLY FARM ACCOUNT BOOK.

Giving Weekly Labour Account and Diary, and showing the Income and Expenditure under each Department of Crops, Live Stock, Dairy, &c., &c. With Valuation, Profit and Loss Account, and Balance Sheet at the End of the Year. By JOHNSON M. WOODMAN, Chartered Accountant. Second Edition. Folio, half-bound *Net* 7/6
 "Contains every requisite form for keeping farm accounts readily and accurately."—*Agriculture*.

THE FORCING GARDEN.

Or, How to Grow Early Fruits, Flowers and Vegetables. With Plans and Estimates for Building Glasshouses, Pits and Frames. With Illustrations. By SAMUEL WOOD. Crown 8vo, cloth 3/6
 "A good book, containing a great deal of valuable teaching."—*Gardeners' Magazine*.

A PLAIN GUIDE TO GOOD GARDENING.

Or, How to Grow Vegetables, Fruits, and Flowers. By S. WOOD. Fourth Edition, with considerable Additions, and numerous Illustrations. Crown 8vo, cloth 3/6
 "A very good book, and one to be highly recommended as a practical guide. The practical directions are excellent."—*Athenæum*.

MULTUM-IN-PARVO GARDENING.

Or, How to Make One Acre of Land produce £620 a year, by the Cultivation of Fruits and Vegetables; also, How to Grow Flowers in Three Glass Houses, so as to realise £176 per annum clear Profit. By SAMUEL WOOD, Author of "Good Gardening," &c. Sixth Edition, Crown 8vo, sewed 1/0
 "We are bound to recommend it as not only suited to the case of the amateur and gentleman's gardener, but to the market grower."—*Gardeners' Magazine*.

THE LADIES' MULTUM-IN-PARVO FLOWER GARDEN.

And Amateur's Complete Guide. By S. WOOD. Crown 8vo, cloth 3/6
 "Full of shrewd hints and useful instructions, based on a lifetime of experience."—*Scotsman*.

POTATOES: HOW TO GROW AND SHOW THEM.

A Practical Guide to the Cultivation and General Treatment of the Potato. By J. PINK. Crown 8vo 2/0

MARKET AND KITCHEN GARDENING.

By C. W. SHAW, late Editor of *Gardening Illustrated*. Cloth 3/6
 "The most valuable compendium of kitchen and market-garden work published."—*Farmer*

AUCTIONEERING, VALUING, LAND SURVEYING, ESTATE AGENCY, &c.

INWOOD'S TABLES FOR PURCHASING ESTATES AND FOR THE VALUATION OF PROPERTIES,

Including Advowsons, Assurance Policies, Copyholds, Deferred Annuities, Freeholds, Ground Rents, Immediate Annuities, Leaseholds, Life Interests, Mortgages, Perpetuities, Renewals of Leases, Reversions, Sinking Funds, &c., &c. 26th Edition, Revised and Extended by WILLIAM SCHOOLING, F.R.A.S., with Logarithms of Natural Numbers and THOMAS' Logarithmic Interest and Annuity Tables. 360 pp., Demy 8vo, cloth.

[Just Published. Net 8/0

"Those interested in the purchase and sale of estates, and in the adjustment of compensation cases, as well as in transactions in annuities, life insurances, &c., will find the present edition of eminent service."—*Engineering*.

"This valuable book has been considerably enlarged and improved by the labours of Mr. Schooling, and is now very complete indeed."—*Economist*.

"Altogether this edition will prove of extreme value to many classes of professional men in saving them many long and tedious calculations."—*Investors' Review*.

THE APPRAISER, AUCTIONEER, BROKER, HOUSE AND ESTATE AGENT AND VALUER'S POCKET ASSISTANT.

For the Valuation for Purchase, Sale, or Renewal of Leases, Annuities, and Reversions, and of Property generally; with Prices for Inventories, &c. By JOHN WHEELER, Valuer, &c. Sixth Edition, Re-written and greatly Extended by C. NORRIS, Surveyor, Valuer, &c. Royal 32mo, cloth 5/0

"A neat and concise book of reference, containing an admirable and clearly arranged list of prices for inventories, and a very practical guide to determine the value of furniture, &c."—*Standard*.

"Contains a large quantity of varied and useful information as to the valuation for purchase, sale, or renewal of leases, annuities and reversions, and of property generally, with prices for inventories, and a guide to determine the value of interior fittings and other effects."—*Builder*.

AUCTIONEERS: THEIR DUTIES AND LIABILITIES.

A Manual of Instruction and Counsel for the Young Auctioneer. By ROBERT SQUIBBS, Auctioneer. Second Edition, Revised and partly Re-written. Demy 8vo, cloth 12/6

"The standard text-book on the topics of which it treats."—*Athenaeum*.

"The work is one of general excellent character, and gives much information in a compendious and satisfactory form."—*Builder*.

"May be recommended as giving a great deal of information on the law relating to auctioneers, in a very readable form."—*Law Journal*.

"Auctioneers may be congratulated on having so pleasing a writer to minister to their special needs."—*Solicitors' Journal*.

THE AGRICULTURAL VALUER'S ASSISTANT.

A Practical Handbook on the Valuation of Landed Estates; including Example of a Detailed Report on Management and Realisation; Forms of Valuations of Tenant Right; Lists of Local Agricultural Customs; Scales of Compensation under the Agricultural Holdings Act, and a Brief Treatise on Compensation under the Lands Clauses Acts, &c. By TOM BRIGHT, Agricultural Valuer. Author of "The Agricultural Surveyor and Estate Agent's Handbook." Fourth Edition, with Appendix containing a Digest of the Agricultural Holdings Acts, 1883 and 1900. Crown 8vo, cloth.

[Just Published. Net 6/0

"Full of tables and examples in connection with the valuation of tenant-right, estates, labour, contents and weights of timber, and farm produce of all kinds."—*Agricultural Gazette*.

"An eminently practical handbook, full of practical tables and data of undoubted interest and value to surveyors and auctioneers in preparing valuations of all kinds."—*Farmer*.

POLE PLANTATIONS AND UNDERWOODS.

A Practical Handbook on Estimating the Cost of Forming, Renovating, Improving, and Grubbing Plantations and Underwoods, their Valuation for Purposes of Transfer, Rental, Sale or Assessment. By TOM BRIGHT. Crown 8vo, cloth 3/6

"To valuers, foresters and agents it will be a welcome aid."—*North British Agriculturist*.

"Well calculated to assist the valuer in the discharge of his duties, and of undoubted interest and use both to surveyors and auctioneers in preparing valuations of all kinds."—*Kent Herald*.

AGRICULTURAL SURVEYOR AND ESTATE AGENT'S HANDBOOK.

Of Practical Rules, Formulæ, Tables, and Data. A Comprehensive Manual for the Use of Surveyors, Agents, Landowners, and others interested in the Equipment, the Management, or the Valuation of Landed Estates. By TOM BRIGHT, Agricultural Surveyor and Valuer, Author of "The Agricultural Valuer's Assistant," &c. With Illustrations. Fcap. 8vo, Leather.

Just Published. Net 7/6

"An exceedingly useful book, the contents of which are admirably chosen. The classes for whom the work is intended will find it convenient to have this comprehensive handbook accessible for reference."—*Live Stock Journal*.

"It is a singularly compact and well informed compendium of the facts and figures likely to be required in estate work, and is certain to prove of much service to those to whom it is addressed."—*Scotsman*.

THE LAND VALUER'S BEST ASSISTANT.

Being Tables on a very much Improved Plan, for Calculating the Value of Estates. With Tables for reducing Scotch, Irish, and Provincial Customary Acres to Statute Measure, &c. By R. HUDSON, C.E. New Edition. Royal 32mo, leather, elastic band 4/0

"Of incalculable value to the country gentleman and professional man."—*Farmers Journal*.

THE LAND IMPROVER'S POCKET-BOOK.

Comprising Formulæ, Tables, and Memoranda required in any Computation relating to the Permanent Improvement of Landed Property. By JOHN EWART, Surveyor. Second Edition, Revised. Royal 32mo, oblong, leather . . . 4/0

"A compendious and handy little volume."—*Spectator*.

THE LAND VALUER'S COMPLETE POCKET-BOOK.

Being the above Two Works bound together. Leather 7/6

HANDBOOK OF HOUSE PROPERTY.

A Popular and Practical Guide to the Purchase, Mortgage, Tenancy, and Compulsory Sale of Houses and Land, including Dilapidations and Fixtures: with Examples of all kinds of Valuations, Information on Building and on the right use of Decorative Art. By E. L. TARBUCK, Architect and Surveyor. Sixth Edition. 12mo, cloth 5/0

"The advice is thoroughly practical."—*Law Journal*.

"For all who have dealings with house property, this is an indispensable guide."—*Decoration*.

"Carefully brought up to date, and much improved by the addition of a division on Fine Art.

A well-written and thoughtful work."—*Land Agent's Record*.

LAW AND MISCELLANEOUS.

MODERN JOURNALISM.

A Handbook of Instruction and Counsel for the Young Journalist. By JOHN B. MACKIE, Fellow of the Institute of Journalists. Crown 8vo, cloth . . . 2/0

"This invaluable guide to journalism is a work which all aspirants to a journalistic career will read with advantage."—*Journalist*.

HANDBOOK FOR SOLICITORS AND ENGINEERS

Engaged in Promoting Private Acts of Parliament and Provisional Orders for the Authorisation of Railways, Tramways, Gas and Water Works, &c. By L. LIVINGSTONE MACASSEY, of the Middle Temple, Barrister-at-Law, M. Inst. C.E. 8vo, cloth £1 5s.

PATENTS for INVENTIONS, HOW to PROCURE THEM.

Compiled for the Use of Inventors, Patentees and others. By G. G. M. HARDINGHAM, Assoc. Mem. Inst. C.E., &c. Demy 8vo, cloth 1/6

CONCILIATION & ARBITRATION in LABOUR DISPUTES.

A Historical Sketch and Brief Statement of the Present Position of the Question at Home and Abroad. By J. S. JEANS, Author of "England's Supremacy &c." Crown 8vo, 200 pp., cloth 2/6

EVERY MAN'S OWN LAWYER.

A Handy-Book of the Principles of Law and Equity. With a Concise Dictionary of Legal Terms. By A BARRISTER. Thirty-ninth Edition, carefully Revised, and including New Acts of Parliament of 1901. Comprising the *Youthful Offenders Act, 1901*; the *Larceny Act, 1901*; the *Intoxicating Liquors Act, 1901*; the *Factory and Workshop Act, 1901*, and other enactments of the year. *Judicial Decisions during the year have also been duly noted.* Crown 8vo, 800 pp., strongly bound in cloth.

Just Published. 6/8

. *This Standard Work of Reference forms a COMPLETE EPITOME OF THE LAWS OF ENGLAND, comprising (amongst other matter):*

THE RIGHTS AND WRONGS OF INDIVIDUALS—LANDLORD AND TENANT—VENDORS AND PURCHASERS—LEASES AND MORTGAGES—PRINCIPAL AND AGENT—PARTNERSHIP AND COMPANIES—MASTERS, SERVANTS AND WORKMEN—CONTRACTS AND AGREEMENTS—BORROWERS, LENDERS AND SURETIES—SALE AND PURCHASE OF GOODS—CHEQUES, BILLS AND NOTES—BILLS OF SALE—BANKRUPTCY—RAILWAY AND SHIPPING LAW—LIFE, FIRE, AND MARINE INSURANCE—ACCIDENT AND FIDELITY INSURANCE—CRIMINAL LAW—PARLIAMENTARY ELECTIONS—COUNTY COUNCILS—DISTRICT COUNCILS—PARISH COUNCILS—MUNICIPAL CORPORATIONS—LIBEL AND SLANDER—PUBLIC HEALTH AND NUISANCES—COPYRIGHT, PATENTS, TRADE MARKS—HUSBAND AND WIFE—DIVORCE—INFANCY—CUSTODY OF CHILDREN—TRUSTEES AND EXECUTORS—CLERGY, CHURCH-WARDENS, &c.—GAME LAWS AND SPORTING—INNKEEPERS—HORSES AND DOGS—TAXES AND DEATH DUTIES—FORMS OF AGREEMENTS, WILLS, CODICILS, NOTICES, &c.

The object of this work is to enable those who consult it to help themselves to the law; and thereby to dispense, as far as possible, with professional assistance and advice. There are many wrongs and grievances which persons submit to from time to time through not knowing how or where to apply for redress; and many persons have as great a dread of a lawyer's office as of a Non's den. With this book at hand it is believed that many a SIX-AND-EIGHTPENCE may be saved; many a wrong redressed; many a right reclaimed; many a law suit avoided; and many an evil abated. The work has established itself as the standard legal adviser of all classes, and has also made a reputation for itself as a useful book of reference for lawyers residing at a distance from law libraries, who are glad to have at hand a work embodying recent decisions and enactments.

OPINIONS OF THE PRESS.

"It is a complete code of English Law written in plain language, which all can understand.

... Should be in the hands of every business man, and all who wish to abolish lawyers bills."—*Weekly Times.*

"A useful and concise epitome of the law, compiled with considerable care."—*Law Magazine.*

"A complete digest of the most useful facts which constitute English law."—*Globe.*

"This excellent handbook. . . . Admirably done, admirably arranged, and admirably cheap."—*Leeds Mercury.*

"A concise, cheap, and complete epitome of the English law. So plainly written that he who runs may read, and he who reads may understand."—*Figure.*

"A dictionary of legal facts well put together. The book is a very useful one."—*Spectator.*

THE PAWNBROKER'S, FACTOR'S, AND MERCHANT'S GUIDE TO THE LAW OF LOANS AND PLEDGES.

With the Statutes and a Digest of Cases. By H. C. FOLKARD, Barrister-at-Law. Cloth 3/6

LABOUR CONTRACTS.

A Popular Handbook on the Law of Contracts for Works and Services. By DAVID GIBBONS. Fourth Edition, with Appendix of Statutes by T. F. UTTLEY, Solicitor. Fcap. 8vo, cloth 3/6

SUMMARY OF THE FACTORY AND WORKSHOP ACTS

(1878-1891). For the Use of Manufacturers and Managers. By EMILE GARCKE and J. M. FELS. (Reprinted from "FACTORY ACCOUNTS.") Crown 8vo, sewed 6s.

WEALE'S SERIES

OF

SCIENTIFIC AND TECHNICAL WORKS.

"It is not too much to say that no books have ever proved more popular with or more useful to young engineers and others than the excellent treatises comprised in WEALE'S SERIES."—**Engineer.**

A New Classified List.

PAGE	PAGE
CIVIL ENGINEERING AND SURVEYING 2	ARCHITECTURE AND BUILDING 6
MINING AND METALLURGY 3	INDUSTRIAL AND USEFUL ARTS. 9
MECHANICAL ENGINEERING. 4	AGRICULTURE, GARDENING, ETC. 10
NAVIGATION, SHIPBUILDING, ETC. 5	MATHEMATICS, ARITHMETIC, ETC. 12
BOOKS OF REFERENCE AND MISCELLANEOUS VOLUMES 14	



CROSBY LOCKWOOD AND SON,
7, STATIONERS' HALL COURT, LONDON, E.C.

1902.

CIVIL ENGINEERING & SURVEYING.

Civil Engineering.

By HENRY LAW, M.Inst.C.E. Including a Treatise on HYDRAULIC ENGINEERING by G. R. BURNELL, M.I.C.E. Seventh Edition, revised, with LARGE ADDITIONS by D. K. CLARK, M.I.C.E. . . . 6/6

Pioneer Engineering:

A Treatise on the Engineering Operations connected with the Settlement of Waste Lands in New Countries. By EDWARD DOBSON, M.Inst.C.E. With numerous Plates. Second Edition 4/6

Iron Bridges of Moderate Span:

Their Construction and Erection. By HAMILTON W. PENDRED. With 40 Illustrations 2/0

Iron and Steel Bridges and Viaducts.

A Practical Treatise upon their Construction for the use of Engineers, Draught-men, and Students. By FRANCIS CAMPIN, C.E. With numerous Illustrations 3/6

Constructional Iron and Steel Work,

As applied to Public, Private, and Domestic Buildings. By FRANCIS CAMPIN, C.E. 3/6

Tubular and other Iron Girder Bridges.

Describing the Britannia and Conway Tubular Bridges. By G. DRYSDALE DEMPSEY, C.E. Fourth Edition 2/0

Materials and Construction:

A Theoretical and Practical Treatise on the Strains, Designing, and Erection of Works of Construction. By FRANCIS CAMPIN, C.E. . . . 3/0

Sanitary Work in the Smaller Towns and in Villages.

By CHARLES SLAGG, Assoc. M.Inst.C.E. Third Edition . . . 3/0

Roads and Streets (The Construction of).

In Two Parts: I. THE ART OF CONSTRUCTING COMMON ROADS, by H. LAW, C.E., Revised by D. K. CLARK, C.E.; II. RECENT PRACTICE: Including Pavements of Wood, Asphalte, &c. By D. K. CLARK, C.E. 4/6

Gas Works (The Construction of),

And the Manufacture and Distribution of Coal Gas. By S. HUGHES, C.E. Re-written by WILLIAM RICHARDS, C.E. Eighth Edition . . . 5/6

Water Works

For the Supply of Cities and Towns. With a Description of the Principal Geological Formations of England as influencing Supplies of Water. By SAMUEL HUGHES, F.G.S., C.E. Enlarged Edition 4/0

The Power of Water,

As applied to drive Flour Mills, and to give motion to Turbines and other Hydrostatic Engines. By JOSEPH GLYNN, F.R.S. New Edition . 2/0

Wells and Well-Sinking.

By JOHN GEO. SWINDELL, A.R.I.B.A., and G. R. BURNELL, C.E. Revised Edition. With a New Appendix on the Qualities of Water. Illustrated 2/0

The Drainage of Lands, Towns, and Buildings.

By G. D. DEMPSEY, C.E. Revised, with large Additions on Recent Practice, by D. K. CLARK, M.I.C.E. Third Edition 4/6

The Blasting and Quarrying of Stone,

For Building and other Purposes. With Remarks on the Blowing up of Bridges. By Gen. Sir J. BURGUYNE, K.C.B. 1/6

Foundations and Concrete Works.

With Practical Remarks on Footings, Planking, Sand, Concrete, Béton, Pile-driving, Caissons, and Cofferdams. By E. DOBSON, M.R.I.B.A. Eighth Edition 1/6

Pneumatics,

Including Acoustics and the Phenomena of Wind Currents, for the Use of Beginners. By CHARLES TOMLINSON, F.R.S. Fourth Edition . 1/6

Land and Engineering Surveying.

For Students and Practical Use. By T. BAKER, C.E. Eighteenth Edition, Revised and Extended by F. E. DIXON, A.M. Inst. C.E., Professional Associate of the Institution of Surveyors. With numerous Illustrations and two Lithographic Plates *[Just published]* 2/0

Mensuration and Measuring.

For Students and Practical Use. With the Mensuration and Levelling of Land for the purposes of Modern Engineering. By T. BAKER, C.E. New Edition by E. NUGENT, C.E. 1/6

MINING AND METALLURGY.**Mining Calculations,**

For the use of Students Preparing for the Examinations for Colliery Managers' Certificates, comprising numerous Rules and Examples in Arithmetic, Algebra, and Mensuration. By T. A. O'DONAHUE, M.E., First-Class Certificated Colliery Manager. *[Just published.]* 3/6

Mineralogy,

Rudiments of. By A. RAMSAY, F.G.S. Fourth Edition, revised and enlarged. Woodcuts and Plates 3/6

Coal and Coal Mining,

A Rudimentary Treatise on. By the late Sir WARINGTON W. SMYTH, F.R.S. Eighth Edition, revised by T. FORSTER BROWN 3/6

Metallurgy of Iron.

Containing Methods of Assay, Analyses of Iron Ores, Processes of Manufacture of Iron and Steel, &c. By H. BAUERMAN, F.G.S. With numerous Illustrations. Sixth Edition, revised and enlarged 5/0

The Mineral Surveyor and Valuer's Complete Guide.

By W. LINTERN. Fourth Edition, with an Appendix on Magnetic and Angular Surveying 3/6

Slate and Slate Quarrying:

Scientific, Practical, and Commercial. By D. C. DAVIES, F.G.S. With numerous Illustrations and Folding Plates. Fourth Edition . . . 3/0

A First Book of Mining and Quarrying,

With the Sciences connected therewith, for Primary Schools and Self Instruction. By J. H. COLLINS, F.G.S. Second Edition 1/6

Subterraneous Surveying,

With and without the Magnetic Needle. By T. FENWICK and T. BAKER, C.E. Illustrated 2/6

Mining Tools.

Manual of. By WILLIAM MORGANS, Lecturer on Practical Mining at the Bristol School of Mines 2/6

Mining Tools, Atlas

Of Engravings to Illustrate the above, containing 235 Illustrations of Mining Tools, drawn to Scale. 4to 4/6

Physical Geology,

Partly based on Major-General PORTLOCK's "Rudiments of Geology." By RALPH TATE, A.L.S., &c. Woodcuts 2/0

Historical Geology,

Partly based on Major-General PORTLOCK's "Rudiments." By RALPH TATE, A.L.S., &c. Woodcuts 2/6

Geology, Physical and Historical.

Consisting of "Physical Geology," which sets forth the Leading Principles of the Science; and "Historical Geology," which treats of the Mineral and Organic Conditions of the Earth at each successive epoch. By RALPH TATE, F.G.S. 4/6

MECHANICAL ENGINEERING.

- The Workman's Manual of Engineering Drawing.**
By JOHN MAXTON, Instructor in Engineering Drawing, Royal Naval College, Greenwich. Seventh Edition. 300 Plates and Diagrams . 3/6
- Fuels: Solid, Liquid, and Gaseous.**
Their Analysis and Valuation. For the Use of Chemists and Engineers. By H. J. PHILLIPS, F.C.S., formerly Analytical and Consulting Chemist to the Great Eastern Railway. Third Edition 2/0
- Fuel, Its Combustion and Economy.**
Consisting of an Abridgment of "A Treatise on the Combustion of Coal and the Prevention of Smoke." By C. W. WILLIAMS, A.I.C.E. With Extensive Additions by D. K. CLARK, M.Inst.C.E. Fourth Edition 3/6
- The Boilermaker's Assistant**
In Drawing, Templating, and Calculating Boiler Work, &c. By J. COURTNEY, Practical Boilermaker. Edited by D. K. CLARK, C.E. 2/0
- The Boiler-Maker's Ready Reckoner,**
With Examples of Practical Geometry and Templating for the Use of Platers, Smiths, and Riveters. By JOHN COURTNEY. Edited by D. K. CLARK, M.I.C.E. Fourth Edition 4/0
- *. * *The last two Works in One Volume, half-bound, entitled "THE BOILER-MAKER'S READY-RECKONER AND ASSISTANT."* By J. COURTNEY and D. K. CLARK. *Price 7/0.*
- Steam Boilers:**
Their Construction and Management. By R. ARMSTRONG, C.E. Illustrated 1/6
- Steam and Machinery Management.**
A Guide to the Arrangement and Economical Management of Machinery. By M. POWIS BALE, M.Inst.M.E. 2/6
- Steam and the Steam Engine,**
Stationary and Portable. Being an Extension of the Treatise on the Steam Engine of Mr. J. SEWELL. By D. K. CLARK, C.E. Fourth Edition 3/6
- The Steam Engine,**
A Treatise on the Mathematical Theory of, with Rules and Examples for Practical Men. By T. BAKER, C.E. 1/6
- The Steam Engine.**
By Dr. LARDNER. Illustrated 1/6
- Locomotive Engines,**
By G. D. DEMPSEY, C.E. With large Additions treating of the Modern Locomotive, by D. K. CLARK, M.Inst.C.E. 3/0
- Locomotive Engine-Driving.**
A Practical Manual for Engineers in charge of Locomotive Engines. By MICHAEL REYNOLDS. Tenth Edition. 3s. 6d. limp; cloth boards 4/6
- Stationary Engine-Driving.**
A Practical Manual for Engineers in charge of Stationary Engines. By MICHAEL REYNOLDS. Sixth Edition. 3s. 6d. limp; cloth boards 4/6
- The Smithy and Forge.**
Including the Farrier's Art and Coach Smithing. By W. J. E. CRANE. Fourth Edition 2/6
- Modern Workshop Practice,**
As applied to Marine, Land, and Locomotive Engines, Floating Docks, Dredging Machines, Bridges, Ship-building, &c. By J. G. WINTON. Fourth Edition, Illustrated 3/6
- Mechanical Engineering.**
Comprising Metallurgy, Moulding, Casting, Forging, Tools, Workshop Machinery, Mechanical Manipulation, Manufacture of the Steam Engine, &c. By FRANCIS CAMPIN, C.E. Third Edition 2/6
- Details of Machinery.**
Comprising Instructions for the Execution of various Works in Iron in the Fitting-Shop, Foundry, and Boiler-Yard. By FRANCIS CAMPIN, C.E. 3/0

Elementary Engineering:

A Manual for Young Marine Engineers and Apprentices. In the Form of Questions and Answers on Metals, Alloys, Strength of Materials, &c. By J. S. BREWER. Fourth Edition 1/6

Power in Motion:

Horse-power Motion, Toothed-Wheel Gearing, Long and Short Driving Bands, Angular Forces, &c. By JAMES ARMOUR, C.E. Third Edition 2/0

Iron and Heat,

Exhibiting the Principles concerned in the Construction of Iron Beams, Pillars, and Girders. By J. ARMOUR, C.E. 2/6

Practical Mechanism,

And Machine Tools. By T. BAKER, C.E. With Remarks on Tools and Machinery, by J. NASMYTH, C.E. 2/6

Mechanics:

Being a concise Exposition of the General Principles of Mechanical Science, and their Applications. By CHARLES TOMLINSON, F.R.S. 1/6

Cranes (The Construction of),

And other Machinery for Raising Heavy Bodies for the Erection of Buildings, &c. By JOSEPH GLYNN, F.R.S. 1/6

NAVIGATION, SHIPBUILDING, ETC.**The Sailor's Sea Book:**

A Rudimentary Treatise on Navigation. By JAMES GREENWOOD, B.A. With numerous Woodcuts and Coloured Plates. New and enlarged Edition. By W. H. ROSSER 2/6

Practical Navigation.

Consisting of THE SAILOR'S SEA-BOOK, by JAMES GREENWOOD and W. H. ROSSER; together with Mathematical and Nautical Tables for the Working of the Problems, by HENRY LAW, C.E., and Prof. J. R. YOUNG. 7/0

Navigation and Nautical Astronomy,

In Theory and Practice. By Prof. J. R. YOUNG. New Edition. 2/6

Mathematical Tables,

For Trigonometrical, Astronomical, and Nautical Calculations; to which is prefixed a Treatise on Logarithms. By H. LAW, C.E. Together with a Series of Tables for Navigation and Nautical Astronomy. By Professor J. R. YOUNG. New Edition 4/0

Masting, Mast-Making, and Rigging of Ships.

Also Tables of Spars, Rigging, Blocks; Chain, Wire, and Hemp Ropes, &c., relative to every class of vessels. By ROBERT KIPPING, N.A. . 2/0

Sails and Sail-Making.

With Draughting, and the Centre of Effort of the Sails. By ROBERT KIPPING, N.A. 2/6

Marine Engines and Steam Vessels.

By R. MURRAY, C.E. Eighth Edition, thoroughly revised, with Additions by the Author and by GEORGE CARLISLE, C.E. 4/6

Naval Architecture:

An Exposition of Elementary Principles. By JAMES PEAKE . . . 3/6

Ships for Ocean and River Service,

Principles of the Construction of. By HAKON A. SOMMERFELDT . 1/6

Atlas of Engravings

To illustrate the above. Twelve large folding Plates. Royal 4to, cloth 7/6

The Forms of Ships and Boats.

By W. BLAND. Ninth Edition, with numerous Illustrations and Models 1/6

**ARCHITECTURE AND THE
BUILDING ARTS.**

Constructional Iron and Steel Work,

As applied to Public, Private, and Domestic Buildings. By FRANCIS CAMPIN, C.E. 3/6

Building Estates :

A Treatise on the Development, Sale, Purchase, and Management of Building Land. By F. MAITLAND. Third Edition 2/0

The Science of Building :

An Elementary Treatise on the Principles of Construction. By E. WYNDHAM TARN, M.A. Lond. Fourth Edition 3/6

The Art of Building :

General Principles of Construction, Strength, and Use of Materials, Working Drawings, Specifications, &c. By EDWARD DOBSON, M.R.I.B.A. . 2/0

A Book on Building,

Civil and Ecclesiastical. By Sir EDMUND BECKETT, Q.C. (Lord GRIMTHORPE). Second Edition 4/6

Dwelling-Houses (The Erection of),

Illustrated by a Perspective View, Plans, and Sections of a Pair of Villas, with Specification, Quantities, and Estimates. By S. H. BROOKS, Architect 2/6

Cottage Building.

By C. BRUCK ALLEN. Eleventh Edition, with Chapter on Economic Cottages for Allotments, by E. E. ALLEN, C.E. 2/0

Acoustics in Relation to Architecture and Building :

The Laws of Sound as applied to the Arrangement of Buildings. By Professor T. ROGER SMITH, F.R.I.B.A. New Edition, Revised . . 1/6

The Rudiments of Practical Bricklaying.

General Principles of Bricklaying; Arch Drawing, Cutting, and Setting; Pointing; Paving, Tiling, &c. By ADAM HAMMOND. With 68 Woodcuts 1/6

The Art of Practical Brick Cutting and Setting.

By ADAM HAMMOND. With 90 Engravings 1/6

Brickwork :

A Practical Treatise, embodying the General and Higher Principles of Bricklaying, Cutting and Setting; with the Application of Geometry to Roof Tiling, &c. By F. WALKER 1/6

Bricks and Tiles,

Rudimentary Treatise on the Manufacture of; containing an Outline of the Principles of Brickmaking. By E. DOBSON, M.R.I.B.A. Additions by C. TOMLINSON, F.R.S. Illustrated 3/0

The Practical Brick and Tile Book.

Comprising: BRICK AND TILE MAKING, by E. DOBSON, M.INST.C.E.; PRACTICAL BRICKLAYING, by A. HAMMOND; BRICK-CUTTING AND SETTING, by A. HAMMOND. 550 pp. with 270 Illustrations, half-bound . . 6/0

Carpentry and Joinery—

THE ELEMENTARY PRINCIPLES OF CARPENTRY. Chiefly composed from the Standard Work of THOMAS TREDGOLD, C.E. With Additions, and TREATISE ON JOINERY, by E. W. TARN, M.A. Seventh Edition 3/6

Carpentry and Joinery—Atlas

Of 35 Plates to accompany and Illustrate the foregoing book. With Descriptive Letterpress. 4to 6/0

- A Practical Treatise on Handrailing;**
Showing New and Simple Methods. By GEO. COLLINGS. Second Edition,
Revised, including a TREATISE ON STAIRBUILDING. With Plates . 2/6
- Circular Work in Carpentry and Joinery.**
A Practical Treatise on Circular Work of Single and Double Curvature.
By GEORGE COLLINGS. Third Edition 2/6
- Roof Carpentry:**
Practical Lessons in the Framing of Wood Roofs. For the Use of Working
Carpenters. By GEO. COLLINGS 2/0
- The Construction of Roofs of Wood and Iron;**
Deduced chiefly from the Works of Robison, Tredgold, and Humber. By
E. WYNDHAM TARN, M.A., Architect. Third Edition 1/6
- The Joints Made and Used by Builders.**
By WYVILL J. CHRISTY, Architect. With 160 Woodcuts 3/0
- Shoring**
And its Application: A Handbook for the Use of Students. By GEORGE
H. BLAGROVE. With 31 Illustrations 1/6
- The Timber Importer's, Timber Merchant's, and
Builder's Standard Guide.**
By R. E. GRANDY 2/0
- Plumbing:**
A Text-Book to the Practice of the Art or Craft of the Plumber. With
Chapters upon House Drainage and Ventilation. By WM. PATON BUCHAN.
Eighth Edition, Re-written and Enlarged, with 500 Illustrations . 3/6
- Ventilation:**
A Text Book to the Practice of the Art of Ventilating Buildings. By W. P.
BUCHAN, R.P., Author of "Plumbing," &c. With 170 Illustrations 3/6
- The Practical Plasterer:**
A Compendium of Plain and Ornamental Plaster Work. By W. KEMP 2/0
- House Painting, Graining, Marbling, & Sign Writing.**
With a Course of Elementary Drawing, and a Collection of Useful Receipts.
By ELLIS A. DAVIDSON. Eighth Edition. Coloured Plates . . . 5/0
. The above, in cloth boards, strongly bound, 6/0
- A Grammar of Colouring,**
Applied to Decorative Painting and the Arts. By GEORGE FIELD. New
Edition, enlarged, by ELLIS A. DAVIDSON. With Coloured Plates . 3/0
- Elementary Decoration**
As applied to Dwelling Houses, &c. By JAMES W. FACEY. Illustrated 2/0
- Practical House Decoration.**
A Guide to the Art of Ornamental Painting, the Arrangement of Colours in
Apartments, and the Principles of Decorative Design. By JAMES W. FACEY
2/6
. The last two Works in One handsome Vol., half-bound, entitled "HOUSE
DECORATION, ELEMENTARY AND PRACTICAL," price 5/0.
- Portland Cement for Users.**
By HENRY FAIJA, A.M.Inst.C.E. Third Edition, Corrected . . . 2/0
- Limes, Cements, Mortars, Concretes, Mastics, Plas-
tering, &c.**
By G. R. BURNELL C.E. Fifteenth Edition 1/6

Masonry and Stone-Cutting.

The Principles of Masonic Projection and their application to Construction
By EDWARD DOBSON, M.R.I.B.A. 2/6

Arches, Piers, Buttresses, &c.:

Experimental Essays on the Principles of Construction. By W. BLAND. 1/6

Quantities and Measurements,

In Bricklayers', Masons', Plasterers', Plumbers', Painters', Paperhangers',
Gilders', Smiths', Carpenters' and Joiners' Work. By A. C. BEATON 1/6

The Complete Measurer:

Setting forth the Measurement of Boards, Glass, Timber and Stone. By R.
HORTON. Sixth Edition 4/0

. *The above, strongly bound in leather, price 5/0.*

Light:

An Introduction to the Science of Optics. Designed for the Use of Students
of Architecture, Engineering, and other Applied Sciences. By E. WYND-
HAM TARN, M.A., Author of "The Science of Building," &c. 1/6

Hints to Young Architects.

By GEORGE WIGHTWICK, Architect. Sixth Edition, revised and enlarged
by G. HUSKISSON GUILLAUME, Architect 3/6

Architecture—Orders:

The Orders and their Aesthetic Principles. By W. H. LEEDS. Illustrated.
1/6

Architecture—Styles:

The History and Description of the Styles of Architecture of Various
Countries, from the Earliest to the Present Period. By T. TALBOT BURY,
F.R.I.B.A. Illustrated 2/0

. ORDERS AND STYLES OF ARCHITECTURE, in One Vol., 3/6.

Architecture—Design:

The Principles of Design in Architecture, as deducible from Nature and
exemplified in the Works of the Greek and Gothic Architects. By EDW.
LACY GARBETT, Architect. Illustrated 2/6

. *The three preceding Works in One handsome Vol., half bound, entitled
"MODERN ARCHITECTURE," price 6/0.*

Perspective for Beginners.

Adapted to Young Students and Amateurs in Architecture, Painting, &c.
By GEORGE PYNE 2/0

Architectural Modelling in Paper.

By T. A. RICHARDSON. With Illustrations, engraved by O. JEWITT 1/6

Glass Staining, and the Art of Painting on Glass.

From the German of Dr. GESSERT and EMANUEL OTTO FROMBERG. With
an Appendix on THE ART OF ENAMELLING 2/6

Vitruvius—The Architecture of.

In Ten Books. Translated from the Latin by JOSEPH GWILT, F.S.A.,
F.R.A.S. With 23 Plates 5/0

N.B.—This is the only Edition of VITRUVIUS procurable at a moderate price.

Grecian Architecture,

An Inquiry into the Principles of Beauty in. With an Historical View of the
Rise and Progress of the Art in Greece. By the EARL OF ABERDEEN 1/0

. *The two preceding Works in One handsome Vol., half bound, entitled
"ANCIENT ARCHITECTURE," price 6/0.*

INDUSTRIAL AND USEFUL ARTS.

- Cements, Pastes, Glues, and Gums.**
A Guide to the Manufacture and Application of Agglutinants. With 900 Recipes and Formulæ. By H. C. STANDAGE 2/0
- Clocks and Watches, and Bells,**
A Rudimentary Treatise on. By Sir EDMUND BECKETT, Q.C. (Lord GRIMTHORPE). Seventh Edition. 4/6
- Electro-Metallurgy,**
Practically Treated. By ALEXANDER WATT. Tenth Edition, enlarged and revised including the most Recent Processes 3/6
- The Goldsmith's Handbook.**
Containing full Instructions in the Art of Alloying, Melting, Reducing, Colouring, Collecting and Refining, Recovery of Waste, Solders, Enamels, &c., &c. By GEORGE E. GEE. Fifth Edition 3/0
- The Silversmith's Handbook,**
On the same plan as the GOLDSMITH'S HANDBOOK. By G. E. GEE. 3/0
** *The last two Works, in One handsome Vol., half-bound, 7/0.*
- The Hall-Marking of Jewellery.**
Comprising an account of all the different Assay Towns of the United Kingdom; with the Stamps and Laws relating to the Standards and Hall Marks at the various Assay Offices. By GEORGE E. GEE 3/0
- French Polishing and Enamelling.**
A Practical Work of Instruction, including numerous Recipes for making Polishes, Varnishes, Glaze-Lacquers, &c. By R. BITHEAD 1/6
- Practical Organ Building.**
By W. E. DICKSON, M.A. Second Edition, Revised, with Additions 2/6
- Coach-Building:**
A Practical Treatise. By JAMES W. BURGESS. With 57 Illustrations 2/6
- The Cabinet-Maker's Guide**
To the Entire Construction of Cabinet Work. By R. BITHEAD 2/6
- The Brass Founder's Manual:**
Instructions for Modelling, Pattern Making, &c. By W. GRAHAM 2/0
- The Sheet-Metal Worker's Guide.**
A Practical Handbook for Tinsmiths, Coppersmiths, Zincworkers, &c., with 46 Diagrams. By W. J. E. CRANE. Third Edition, revised 1/6
- Sewing Machinery:**
Its Construction, History, &c. With full Technical Directions for Adjusting, &c. By J. W. URQUHART, C.E. 2/0
- Gas Fitting:**
A Practical Handbook. By JOHN BLACK. New Edition 2/6
- Construction of Door Locks.**
From the Papers of A. C. HOBBS. Edited by C. TOMLINSON, F.R.S. 2/6
- The Model Locomotive Engineer, Fireman, and Engine-Boy.**
By MICHAEL REYNOLDS 3/6
- The Art of Letter Painting made Easy.**
By J. G. BADENOCH. With 12 full-page Engravings of Examples 1/6
- The Art of Boot and Shoemaking.**
Including Measurement, Last-fitting, Cutting-out, Closing and Making. By JOHN BEDFORD LENO. With numerous Illustrations. Fourth Edition 2/0
- Mechanical Dentistry:**
A Practical Treatise on the Construction of the Various Kinds of Artificial Dentures. By CHARLES HUNTER. Fourth Edition 3/0
- Wood Engraving:**
A Practical and Easy Introduction to the Art. By W. N. BROWN 1/9
- Laundry Management.**
A Handbook for Use in Private and Public Laundries 2/0

AGRICULTURE, GARDENING, ETC.

Draining and Embanking:

A Practical Treatise. By Prof. JOHN SCOTT. With 68 Illustrations 1/6

Irrigation and Water Supply:

A Practical Treatise on Water Meadows, Sewage Irrigation, Warping, &c.; on the Construction of Wells, Ponds, Reservoirs, &c. By Prof. JOHN SCOTT. With 34 Illustrations 1/6

Farm Roads, Fences, and Gates:

A Practical Treatise on the Roads, Tramways, and Waterways of the Farm; the Principles of Enclosures; and the different kinds of Fences, Gates, and Stiles. By Prof. JOHN SCOTT. With 75 Illustrations . 1/6

Farm Buildings:

A Practical Treatise on the Buildings necessary for various kinds of Farms, their Arrangement and Construction, with Plans and Estimates. By Prof. JOHN SCOTT. With 105 Illustrations 2/0

Barn Implements and Machines:

Treating of the Application of Power and Machines used in the Threshing-barn, Stockyard, Dairy, &c. By Prof. J. SCOTT. With 123 Illustrations. 2/0

Field Implements and Machines:

With Principles and Details of Construction and Points of Excellence, their Management, &c. By Prof. JOHN SCOTT. With 138 Illustrations 2/0

Agricultural Surveying:

A Treatise on Land Surveying, Levelling, and Setting-out; with Directions for Valuing Estates. By Prof. J. SCOTT. With 62 Illustrations . 1/6

Farm Engineering.

By Professor JOHN SCOTT. Comprising the above Seven Volumes in One, 1,150 pages, and over 600 Illustrations. Half-bound 12/0

Outlines of Farm Management.

Treating of the General Work of the Farm; Stock; Contract Work; Labour, &c. By R. SCOTT BURN 2/6

Outlines of Landed Estates Management.

Treating of the Varieties of Lands, Methods of Farming, Setting-out of Farms, Roads, Fences, Gates, Drainage, &c. By R. SCOTT BURN . 2/6
 . The above Two Vols. in One, handsomely half-bound, price 6/0

Soils, Manures, and Crops.

(Vol. I. OUTLINES OF MODERN FARMING.) By R. SCOTT BURN . 2/0

Farming and Farming Economy.

(Vol. II. OUTLINES OF MODERN FARMING.) By R. SCOTT BURN 3/0

Stock: Cattle, Sheep, and Horses.

(Vol. III. OUTLINES OF MODERN FARMING.) By R. SCOTT BURN 2/6

Dairy, Pigs, and Poultry.

(Vol. IV. OUTLINES OF MODERN FARMING.) By R. SCOTT BURN 2/0

Utilization of Sewage, Irrigation, and Reclamation of Waste Land.

(Vol. V. OUTLINES OF MODERN FARMING.) By R. SCOTT BURN . 2/6

Outlines of Modern Farming.

By R. SCOTT BURN. Consisting of the above Five Volumes in One, 1,250 pp., profusely Illustrated, half-bound 12/0

Book-keeping for Farmers and Estate Owners.

A Practical Treatise, presenting, in Three Plans, a System adapted for all classes of Farms. By J. M. WOODMAN. Third Edition, revised . 2/6

Ready Reckoner for the Admeasurement of Land.

By A. ARMAN. Fourth Edition, revised and extended by C. NORRIS 2/0

Miller's, Corn Merchant's, and Farmer's Ready Reckoner.

Second Edition, revised, with a Price List of Modern Flour Mill Machinery, by W. S. HUTTON, C.E. 2/0

The Hay and Straw Measurer.

New Tables for the Use of Auctioneers, Valuers, Farmers, Hay and Straw Dealers, &c. By JOHN STEELE 2/0

Meat Production.

A Manual for Producers, Distributors, and Consumers of Butchers' Meat. By JOHN EWART 2/6

Sheep :

The History, Structure, Economy, and Diseases of. By W. C. SPOONER, M.R.V.S. Fifth Edition, with fine Engravings. 3/6

Market and Kitchen Gardening.

By C. W. SHAW, late Editor of "Gardening Illustrated" 3/0

Kitchen Gardening Made Easy.

Showing the best means of Cultivating every known Vegetable and Herb, &c., with directions for management all the year round. By GEORGE M. F. GLENNY. Illustrated 1/6

Cottage Gardening :

Or Flowers, Fruits, and Vegetables for Small Gardens. By E. HOBDAY. 1/6

Garden Receipts.

Edited by CHARLES W. QUIN 1/6

Fruit Trees,

The Scientific and Profitable Culture of. From the French of M. DU BREUIL. Fifth Edition, carefully Revised by GEORGE GLENNY. With 187 Woodcuts 3/6

The Tree Planter and Plant Propagator :

With numerous Illustrations of Grafting, Layering, Budding, Implements, Houses, Pits, &c. By SAMUEL WOOD 2/0

The Tree Pruner :

A Practical Manual on the Pruning of Fruit Trees, Shrubs, Climbers, and Flowering Plants. With numerous Illustrations. By SAMUEL WOOD 1/6

, *The above Two Vols. in One, handsomely half-bound, price 3/6.*

The Art of Grafting and Budding.

By CHARLES BALLET. With Illustrations 2/6

MATHEMATICS, ARITHMETIC, ETC.**Descriptive Geometry,**

An Elementary Treatise on; with a Theory of Shadows and of Perspective, extracted from the French of G. MONGE. To which is added a Description of the Principles and Practice of Isometrical Projection. By J. F. HEATHER, M.A. With 14 Plates 2/0

Practical Plane Geometry:

Giving the Simplest Modes of Constructing Figures contained in one Plane and Geometrical Construction of the Ground. By J. F. HEATHER, M.A. With 215 Woodcuts 2/0

Analytical Geometry and Conic Sections,

A Rudimentary Treatise on. By JAMES HANN. A New Edition, rewritten and enlarged by Professor J. R. YOUNG 2/0

Euclid (The Elements of).

With many Additional Propositions and Explanatory Notes; to which is prefixed an Introductory Essay on Logic. By HENRY LAW, C.E. 2/6

. Sold also separately, viz:—

Euclid. The First Three Books. By HENRY LAW, C.E. 1/6

Euclid. Books 4, 5, 6, 11, 12. By HENRY LAW, C.E. 1/6

Plane Trigonometry,

The Elements of. By JAMES HANN. 1/6

Spherical Trigonometry,

The Elements of. By JAMES HANN. Revised by CHARLES H. DOWLING, C.E. 1/0

. Or with "The Elements of Plane Trigonometry," in One Volume, 2/6

Differential Calculus,

Elements of the. By W. S. B. WOOLHOUSE, F.R.A.S., &c. 1/6

Integral Calculus.

By HOMERSHAM COX, B.A. 1/6

Algebra,

The Elements of. By JAMES HADDON, M.A. With Appendix, containing Miscellaneous Investigations, and a Collection of Problems 2/0

A Key and Companion to the Above.

An extensive Repository of Solved Examples and Problems in Algebra. By J. R. YOUNG 1/6

Commercial Book-keeping.

With Commercial Phrases and Forms in English, French, Italian, and German. By JAMES HADDON, M.A. 1/6

Arithmetic,

A Rudimentary Treatise on. With full Explanations of its Theoretical Principles, and numerous Examples for Practice. For the Use of Schools and for Self-Instruction. By J. R. YOUNG, late Professor of Mathematics in Belfast College. Thirteenth Edition 1/6

A Key to the Above.

By J. R. YOUNG 1/6

Equational Arithmetic,

Applied to Questions of Interest, Annuities, Life Assurance, and General Commerce; with various Tables by which all Calculations may be greatly facilitated. By W. HIPSLEY 1/6

Arithmetic,

Rudimentary, for the Use of Schools and Self-Instruction. By JAMES HADDON, M.A. Revised by ABRAHAM ARMAN 1/6

A Key to the Above.

By A. ARMAN 1/6

Mathematical Instruments:

Their Construction, Adjustment, Testing, and Use concisely Explained. By J. F. HEATHER, M.A., of the Royal Military Academy, Woolwich. Fourteenth Edition, Revised, with Additions, by A. T. WALMSLEY, M.I.C.E. Original Edition, in 1 vol., Illustrated 2/0

*. In ordering the above, be careful to say "Original Edition," or give the number in the Series (32), to distinguish it from the Enlarged Edition in 3 vols. (as follows)—

Drawing and Measuring Instruments.

Including—I. Instruments employed in Geometrical and Mechanical Drawing, and in the Construction, Copying, and Measurement of Maps and Plans. II. Instruments used for the purposes of Accurate Measurement, and for Arithmetical Computations. By J. F. HEATHER, M.A. 1/6

Optical Instruments.

Including (more especially) Telescopes, Microscopes, and Apparatus for producing copies of Maps and Plans by Photography. By J. F. HEATHER, M.A. Illustrated 1/6

Surveying and Astronomical Instruments.

Including—I. Instruments used for Determining the Geometrical Features of a portion of Ground. II. Instruments employed in Astronomical Observations. By J. F. HEATHER, M.A. Illustrated. 1/6

*. The above three volumes form an enlargement of the Author's original work, "Mathematical Instruments," price 2/0. (Described at top of page.)

Mathematical Instruments:

Their Construction, Adjustment, Testing and Use. Comprising Drawing, Measuring, Optical, Surveying, and Astronomical Instruments. By J. F. HEATHER, M.A. Enlarged Edition, for the most part entirely re-written. The Three Parts as above, in One thick Volume. 4/6

The Slide Rule, and How to Use It.

Containing full, easy, and simple Instructions to perform all Business Calculations with unexampled rapidity and accuracy. By CHARLES HOARE, C.E. With a Slide Rule, in tuck of cover. Seventh Edition 2/6

Logarithms.

With Mathematical Tables for Trigonometrical, Astronomical, and Nautical Calculations. By HENRY LAW, C.E. Revised Edition 3/0

Compound Interest and Annuities (Theory of).

With Tables of Logarithms for the more Difficult Computations of Interest, Discount, Annuities, &c., in all their Applications and Uses for Mercantile and State Purposes. By FEDOR THOMAN, Paris. Fourth Edition 4/0

Mathematical Tables,

For Trigonometrical, Astronomical, and Nautical Calculations; to which is prefixed a Treatise on Logarithms. By H. LAW, C.E. Together with a Series of Tables for Navigation and Nautical Astronomy. By Professor J. R. YOUNG. New Edition 4/0

Mathematics,

As applied to the Constructive Arts. By FRANCIS CAMPIN, C.E., &c. Third Edition 3/0

Astronomy.

By the late Rev. ROBERT MAIN, F.R.S. Third Edition, revised and corrected to the Present Time. By W. T. LYNN, F.R.A.S. 2/0

Statics and Dynamics,

The Principles and Practice of. Embracing also a clear development of Hydrostatics, Hydrodynamics, and Central Forces. By T. BAKER, C.E. Fourth Edition 1/6

**BOOKS OF REFERENCE AND
MISCELLANEOUS VOLUMES.**

A Dictionary of Painters, and Handbook for Picture Amateurs.

Being a Guide for Visitors to Public and Private Picture Galleries, and for Art-Students, including Glossary of Terms, Sketch of Principal Schools of Painting, &c. By PHILIPPE DARYL, B.A. 2/6

Painting Popularly Explained.

By T. J. GULLICK, Painter, and JOHN TIMBS, F.S.A. Including Fresco, Oil, Mosaic, Water Colour, Water-Glass, Tempera Encaustic, Miniature, Painting on Ivory, Vellum, Pottery, Enamel, Glass, &c. Sixth Edition 5/0

A Dictionary of Terms used in Architecture, Building, Engineering, Mining, Metallurgy, Archæology, the Fine Arts, &c.

By JOHN WEALE. Sixth Edition. Edited by R. HUNT, F.R.S. . 5/0

Music:

A Rudimentary and Practical Treatise. With numerous Examples. By CHARLES CHILD SPENCER 2/6

Pianoforte,

The Art of Playing the. With numerous Exercises and Lessons. By CHARLES CHILD SPENCER 1/6

The House Manager.

A Guide to Housekeeping, Cookery, Pickling and Preserving, Household Work, Dairy Management, Cellarage of Wines, Home-brewing and Wine-making, Gardening, &c. By AN OLD HOUSEKEEPER 3/6

Manual of Domestic Medicine.

By R. GOODING, M.D. Intended as a Family Guide in all cases of Accident and Emergency. Third Edition, carefully revised 2/0

Management of Health.

A Manual of Home and Personal Hygiene. By Rev. JAMES BAIRD 1/0

Natural Philosophy,

For the Use of Beginners. By CHARLES TOMLINSON, F.R.S. 1/6

The Elementary Principles of Electric Lighting.

By ALAN A. CAMPBELL SWINTON, M.INST.C.E., M.I.E.E. Fourth Edition, Revised [Just Published 1/6

The Electric Telegraph,

Its History and Progress. By R. SABINE, C.E., F.S.A., &c. 3/0

Handbook of Field Fortification.

By Major W. W. KNOLLYS, F.R.G.S. With 163 Woodcuts 3/0

Logic,

Pure and Applied. By S. H. EMMENS. Third Edition 1/6

Locke on the Human Understanding,

Selections from. With Notes by S. H. EMMENS 1/6

The Compendious Calculator

(*Intuitive Calculations*). Or Easy and Concise Methods of Performing the various Arithmetical Operations required in Commercial and Business Transactions; together with Useful Tables, &c. By DANIEL O'GORMAN. Twenty-seventh Edition, carefully revised by C. NORRIS 2/6

- Measures, Weights, and Moneys of all Nations.**
 With an Analysis of the Christian, Hebrew, and Mahometan Calendars.
 By W. S. B. WOOLHOUSE, F.R.A.S., F.S.S. Seventh Edition 2/6
- Grammar of the English Tongue,**
 Spoken and Written. With an Introduction to the Study of Comparative
 Philology. By HYDE CLARKE, D.C.L. Fifth Edition. 1/6
- Dictionary of the English Language.**
 As Spoken and Written. Containing above 100,000 Words. By HYDE
 CLARKE, D.C.L. 3/6
Complete with the GRAMMAR, 5/6.
- Composition and Punctuation,**
 Familiarly Explained for those who have neglected the Study of Grammar.
 By JUSTIN BRENNAN. 18th Edition. 1/6
- French Grammar.**
 With Complete and Concise Rules on the Genders of French Nouns. By
 G. L. STRAUSS, Ph.D. 1/6
- English-French Dictionary.**
 Comprising a large number of Terms used in Engineering, Mining, &c.
 By ALFRED ELWES 2/0
- French Dictionary.**
 In two Parts—I. French-English. II. English-French, complete in
 One Vol. 3/0
** * Or with the GRAMMAR, 4/6.*
- French and English Phrase Book.**
 Containing Introductory Lessons, with Translations, Vocabularys of Words,
 Collection of Phrases, and Easy Familiar Dialogues 1/6
- German Grammar.**
 Adapted for English Students, from Heyse's Theoretical and Practical
 Grammar, by Dr. G. L. STRAUSS 1/6
- German Triglot Dictionary.**
 By N. E. S. A. HAMILTON. Part I. German-French-English. Part II.
 English-German-French. Part III. French-German-English 3/0
- German Triglot Dictionary.**
 (As above). Together with German Grammar, in One Volume 5/0
- Italian Grammar.**
 Arranged in Twenty Lessons, with Exercises. By ALFRED ELWES. 1/6
- Italian Triglot Dictionary,**
 Wherein the Genders of all the Italian and French Nouns are carefully
 noted down. By ALFRED ELWES. Vol. I. Italian-English-French. 2/6
- Italian Triglot Dictionary.**
 By ALFRED ELWES. Vol. II. English-French-Italian 2/6
- Italian Triglot Dictionary.**
 By ALFRED ELWES. Vol. III. French-Italian-English 2/6
- Italian Triglot Dictionary.**
 (As above). In One Vol. 7/6
- Spanish Grammar.**
 In a Simple and Practical Form. With Exercises. By ALFRED ELWES 1/6
- Spanish-English and English-Spanish Dictionary.**
 Including a large number of Technical Terms used in Mining, Engineering,
 &c., with the proper Accents and the Gender of every Noun. By ALFRED
 ELWES 4/0
** * Or with the GRAMMAR, 6/0.*

16 WEALE'S SCIENTIFIC AND TECHNICAL SERIES.

Portuguese Grammar,

In a Simple and Practical Form. With Exercises. By ALFRED ELWES 1/6

Portuguese-English and English-Portuguese Dictionary.

Including a large number of Technical Terms used in Mining, Engineering, &c., with the proper Accents and the Gender of every Noun. By ALFRED ELWES. Third Edition, revised 5/0

. Or with the GRAMMAR, 7/0.

Animal Physics,

Handbook of. By DIONYSIUS LARDNER, D.C.L. With 520 Illustrations. In One Vol. (732 pages), cloth boards 7/6

. Sold also in Two Parts, as follows:—

ANIMAL PHYSICS. By Dr. LARDNER. Part I., Chapters I.—VII. 4/0

ANIMAL PHYSICS. By Dr. LARDNER. Part II., Chapters VIII.—XVII. 3/0

WEALE'S SCIENTIFIC & TECHNICAL SERIES.

MATHEMATICS, ARITHMETIC, &c.

Geometry, Descriptive. J. F. HEATHER	2/-
Practical Plane Geometry. J. F. HEATHER.	2/-
Analytical Geometry. J. HANN & J. R. YOUNG.	2/-
Geometry. Part I. (Euclid, Bks. I.—III.) H. LAW	1/6
Part II. (Euclid, Books IV., V., VI., XI., XII.). H. LAW	1/6
Geometry, in 1 vol. (Euclid's Elements)	2/6
Plane Trigonometry. J. HANN	1/6
Spherical Trigonometry. J. HANN	1/-
The above 2 vols., bound together	2/6
Differential Calculus. W. S. B. WOOLHOUSE	1/6
Integral Calculus. H. COX	1/6
Integral Calculus. J. HANN	1/-
Algebra. J. HADDON	2/-
Key to ditto	1/6
Book-keeping. J. HADDON	1/6
Arithmetic. J. R. YOUNG	1/6
Key to ditto	1/6
Equational Arithmetic. W. HIPSLEY	1/6
Arithmetic. J. HADDON	1/6
Key to ditto	1/6
Mathematical Instruments. HEATHER & WALMISLEY	2/-
Drawing & Measuring Instruments. J. F. HEATHER	1/6
Optical Instruments. J. F. HEATHER	1/6
Surveying & Astronomical Instruments. J. F. HEATHER	1/6
The above 3 vols., bound together	4/6
Mensuration and Measuring. T. BAKER	1/6
Slide Rule, & How to Use it. C. HOARE	2/6
Measures, Weights, & Monies. W. S. B. WOOLHOUSE	2/6
Logarithms, Treatise on, with Tables. H. LAW	3/-
Compound Interest and Annuities. F. THOMAN	4/-
Compendious Calculator. D. O'GORMAN	2/6
Mathematics. F. CAMPIN	3/-
Astronomy. R. MAIN & W. T. LYNN	2/-
Statics and Dynamics. T. BAKER	1/6
Superficial Measurement. J. HAWKINGS	3/6

89067683797



B89067683797A

IFIC & TECHNICAL SERIES.

BUILDING & ARCHITECTURE.

Building Estates. F. MAITLAND	2/-
Science of Building. E. W. TARN	3/6
Building, Art of. E. DOBSON	2/-
Book on Building. Sir E. BECKETT	4/6
Dwelling Houses, Erection of. S. H. BROOKS	2/6
Cottage Building. C. B. ALLEN	2/-
Acoustics of Public Buildings. Prof. T. R. SMITH	1/6
Practical Bricklaying. A. HAMMOND	1/6
Practical Brick Cutting & Setting. A. HAMMOND	1/6
Brickwork. F. WALKER	1/6
Brick and Tile Making. E. DOBSON	3/-
Practical Brick & Tile Book. DOBSON & HAMMOND	6/-
Carpentry and Joinery. T. TREGOLD & E. W. TARN	3/6
Atlas of 35 plates to the above	6/-
Handrailing and Staircasing. G. COLLINGS	2/6
Circular Work in Carpentry. G. COLLINGS	2/6
Roof Carpentry. G. COLLINGS	2/-
Construction of Roofs. E. W. TARN	1/6
Joints used by Builders. J. W. CHRISTY	3/-
Shoring. G. H. BLAGROVE	1/6
Timber Importer's & Builder's Guide. R. E. GRANDY	2/-
Plumbing. W. P. BUCHAN	3/6
Ventilation of Buildings. W. P. BUCHAN	3/6
Practical Plasterer. W. KEMP	2/-
House-Painting. E. A. DAVIDSON	5/-
Elementary Decoration. J. W. FACEY	2/-
Practical House Decoration. J. W. FACEY	2/6
Gas-Fitting. J. BLACK	2/6
Portland Cement for Users. H. FAJJA	2/-
Limes, Cements, & Mortars. G. R. BURNELL	1/6
Masonry and Stone Cutting. E. DOBSON	2/6
Arches, Piers, and Buttresses. W. BLAND	1/6
Quantities and Measurements. A. C. BEATON	1/6
Complete Measurer. R. HORTON	4/-
Light, for use of Architects. E. W. TARN	1/6
Hints to Young Architects. WIGHTWICK & GUILLAUME	3/6
Dictionary of Architectural Terms. J. WEALE	5/-

CROSBY LOCKWOOD & SON, 7, Stationers' Hall Court, E.C.

T30
ST8

Brass Founder's Manual. W. GRAHAM	2/-
French Polishing and Enamelling. R. BITMEAD	1/6
House Decoration. J. W. FACEY	5/-
Letter-Painting Made Easy. J. G. BADENOCH	1/6
Boot and Shoemaking. J. B. LENO	2/-
Mechanical Dentistry. C. HUNTER	3/-
Wood Engraving. W. N. BROWN	1/6
Laundry Management	2/-

CROSBY LOCKWOOD & SON, 7, Stationers' Hall Court, E.C.

89067683797



b89067683797a